









Installation Instructions

KNOCK DOWN INSTATRUNK™

Vehicle Application:

- Jeep® Wrangler
1986 – 1995
Part Number: 42700

INSTALLATION TIME	SKILL LEVEL
 3/4 Hour	1 <input type="radio"/> 2 <input type="radio"/> 3 <input type="radio"/> 4 <input type="radio"/> 1 - Easy

TOOLS				
 Phillips Screwdriver	 Socket M13 and 9mm	 Wrench M13	 Ratchet	 Safety Glasses



! WARNING This product is designed primarily to enhance the appearance of the vehicle. Do not rely in any way on the components of this product to protect against injury or death in the event of an accident. Never operate the vehicle in excess of manufacturer's specifications.

WEAR SEAT BELTS AT ALL TIMES

Read and follow, precisely, all installation instructions provided when installing product. Failure to do so may result in a poor fit and could place occupants of the vehicle in a potentially dangerous situation.

KNOCK DOWN INSTATRUNK™ Installation Instructions

Parts List

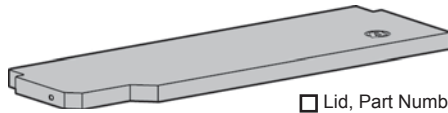

☐ Lid, Part Number 494.97, Qty - 1

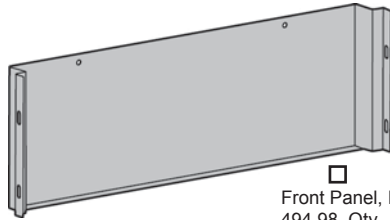

☐ Front Panel, Part Number 494.98, Qty - 1

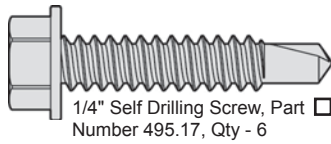

☐ 1/4" Self Drilling Screw, Part Number 495.17, Qty - 6

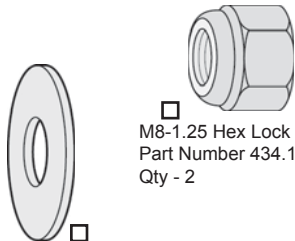

☐ M10 Flat Washer, Part Number 481.58, Qty - 2

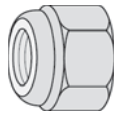

☐ M8-1.25 Hex Lock Nut, Part Number 434.12, Qty - 2

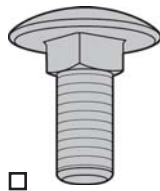

☐ M8-1.25 x 20mm Carriage Bolt, Part Number 497.58, Qty - 2

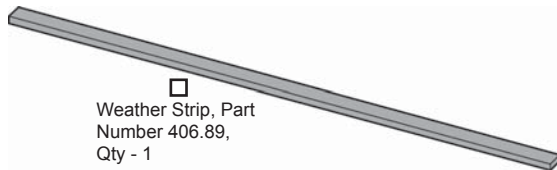

☐ Weather Strip, Part Number 406.89, Qty - 1

1 Assemble INSTATRUNK™

Use the M8-1.25 x 20mm Carriage Bolts, M10 Flat Washers and M8-1.25 Hex Lock Nuts to assemble the Lid to the Front Panel.

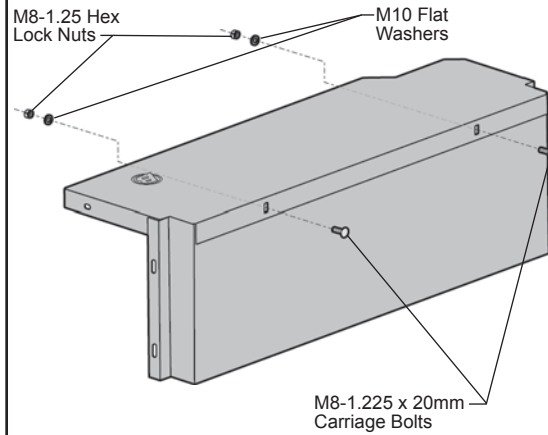

2 Install Weather Strip

Locate the Weather Strip in the parts kit. From the rear of the trunk, start installing the Weather Strip along the rear edge so that it will form a seal between the Instatrunk™ and the tailgate. Start on the driver's side and work across to the passenger's side. Peel the backing off the Weather Strip a few inches at a time and press the adhesive on the Weather Strip onto the edge of the trunk.

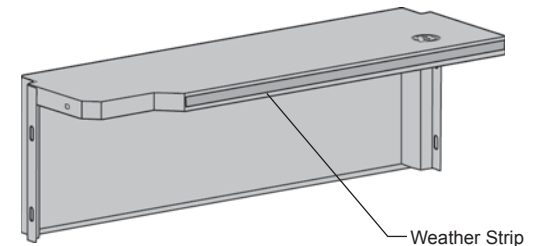

KNOCK DOWN INSTATRUNK™ Installation Instructions

3 Install INSTATRUNK™

Open the tailgate of the vehicle and lean the rear seat back forward.

Place the Instatrunk™ in the vehicle so that it fits snugly between the wheel wells with the top level with the top of the wheel wells and with the notches around the plastic seat belt covers. Make sure that the contoured edge of the trunk with the Weather Strip is flush against the tailgate. Close the tailgate to check that the Weather Strip forms a seal against the tailgate. Adjust the position of the trunk as needed.

NOTE In some cases there may be extra padding under the carpet, in this case it may be necessary to remove it for the Instatrunk™ to fit properly.

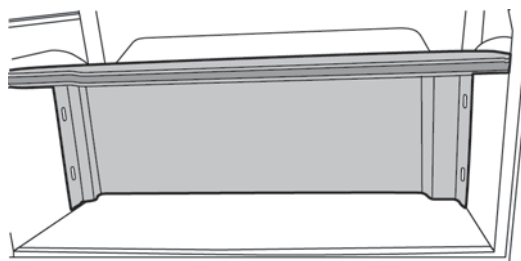

CAUTION

Do not drill into the floor of your vehicle. The Instatrunk™ must

be securely installed in the vehicle during vehicle operation.

4 Secure INSTATRUNK™

Locate the six pre-drilled holes in the INSTATRUNK™. Install a 1/4" Self Drilling Screw at each location.

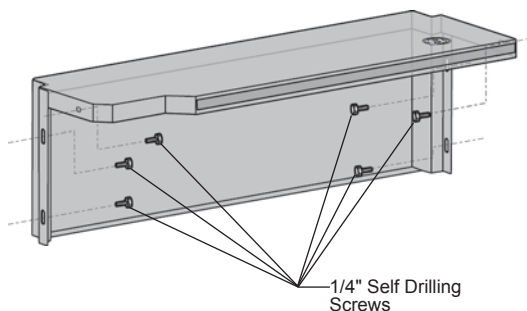

NOTE

To use the rear seat, use the lever in front of the seat back on the driver's side.