



INSTALLATION INSTRUCTIONS

2511
2" DROP SPINDLE 2WD
(Must Use 17" or larger wheels AND be used for 3+" lowering)
07-14 SILVERADO/SIERRA 1500, SUBURBAN, TAHOE
YUKON, YUKON XL, AVALANCHE, DENALI or ESCALADE

>>> NOTE: Will NOT fit 2007 CHEVY 1500 Classic <<<

Thank you for being selective enough to choose a BELLTECH product. We have spent many hours developing our line of products so that you will receive maximum performance with minimum difficulty during installation.

- Note: Confirm that all of the hardware listed in the parts list is in the kit. **Do not** begin installation if any part is missing. Read the instructions thoroughly before beginning this installation.
- Warning:** **DO NOT** work under a vehicle supported by only a jack. Place support stands securely under **the vehicle in the manufacturer's specified locations unless otherwise instructed.**
- Warning:** **DO NOT** drive vehicle until all work has been completed and checked. Torque all hardware to values specified.
- Reminder: Proper use of safety equipment and eye/face/hand protection is absolutely necessary when using these tools to perform procedures!
- Note: It is very helpful to have an assistant available during installation.

RECOMMENDED TOOLS:

- Properly rated floor jack, support stands, and wheel chocks
- Combination wrench set
- Allen wrench set
- Screwdriver set
- Pliers
- Chisel or punch and hammer
- Abrasive cutter or grinder
- Torque wrench: *up to 200 lb ft. range*
- Socket wrench set
- Safety Glasses

1. KIT PREPERATION

- a) Open the hardware kit and remove all of the contents. Refer to the part list (Page 6) to verify that all parts are present.
- b) Park the vehicle on a smooth, level concrete or seasoned asphalt surface and activate the parking brake. Block the REAR wheels of the vehicle with appropriate wheel chocks; making sure the vehicle's transmission is in 1st gear (manual) or "Park" (automatic).
Using a properly rated floor jack, lift the front wheels of the vehicle off the ground. Place support stands, rated for the vehicle's weight, in the factory specified locations. Refer to the vehicle Owner's Manual. Prior to lowering the vehicle onto the stands, make sure the supports will securely contact the chassis.

! It is very important that the vehicle is properly supported during this installation to prevent personal injury and chassis damage! Make sure that the supports stands are properly placed prior to performing the following procedures. We **DO NOT RECOMMEND** using wheel ramps while performing this installation.

Slowly lower the vehicle onto the stands and, before placing the vehicle's entire weight on them, again

check that they properly and securely contact the chassis as described above. Check for possible interference with any lines, wires, cables, or other easily damaged components

2. Steering Knuckle Removal

- a) Starting on the passenger side of the vehicle, remove the wheel from the steering knuckle. Unbolt the brackets connecting the hydraulic brake line to the top of the steering knuckle and on the upper control arm using a 10mm socket (Photo 1). Disconnect the electronic ABS sensor from the connector behind the shock. Using a screwdriver and/or pliers disconnect the plastic hold down clips on the frame, control arm, and brake line bracket freeing the sensor wire from the suspension.
- b) Remove the brake caliper assembly from the steering knuckle with an 18mm socket. With a metal hook or wire attach the caliper to chassis so that it doesn't dangle and damage the brake line.
- c) Remove the brake rotor.
- d) Remove the three bolts on the backside of the hub assembly, disconnecting it from the steering knuckle (Photo 3). Remove the hub assembly and backing plate (Photo 4).
- e) Loosen the upper control arm ball joint nut, it's helpful to keep the ball joint nut partially threaded on to keep the arm from swinging up and to keep it in place while removing the lower ball joint. Using a ball joint removal tool, free the upper control arm ball joint from the steering knuckle. (Photo 5).

! It is helpful to use a jack or lifting device to raise the lower control arm while removing the spindle ball joints. Be very cautious when lifting the lower control arm because it is under extreme load. Make sure the lifting device base is stable and the portion connected

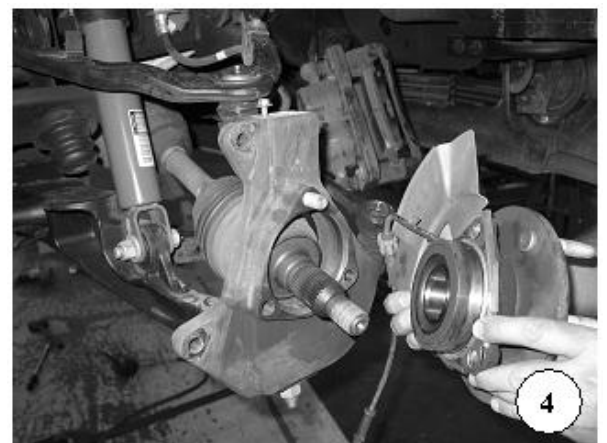
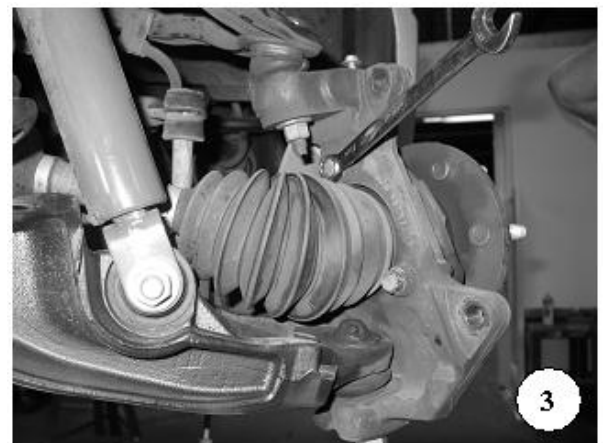
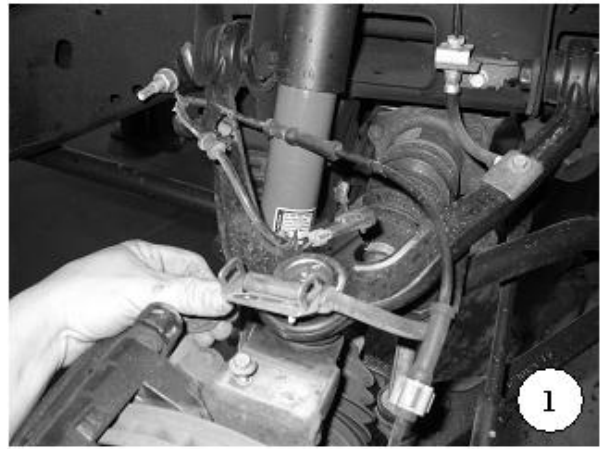

to the lower control isn't able to slip out.

- f) Remove the tie rod end using the same ball joint removal tool. Disconnect it from the steering knuckle.
 - g) Loosen the lower ball joint nut for ball joint removal using a 24mm socket. Depending on the type of ball joint removal tool you have available, it might be necessary to devise a tool to free the lower ball joint (Photo 6).
- !
- h1) Unthread the lower ball joint nut about ½ inch.
 - h2) Locate a piece of thick wall tubing or solid stock with a relieved hole for the ball joint stud.
 - h3) Hold the tool up to the bottom of the nut and forcefully strike the tool in an upward motion. It should only take one blow to break the ball joint loose so check if it has been loosened before another blow is taken (Photo 6).

!

Another known way to remove the lower ball joint is to use a large hammer and forcefully strike the lower ball joint boss. This striking action will usually free the ball joint with one swing.

- h) Remove the steering knuckle from the vehicle (Photo 7).

3. Steering Knuckle Installation

When using 17" wheels you must use the supplied nut and lock washer on the lower ball joint then trim the ball joint stud for adequate clearance (illustration 18). Photo 16 shows the backside of the 2511 steering knuckle with a stock 17" wheel. The supplied lock washer and nut should be installed and torqued to 60 ft. lbs. Before the ball joint stud is trimmed, it is recommended that when you remove the lower portion of the stud you leave at least 1/16" of the stud extended out from the nut. It is also recommended that once the stud is trimmed off you use a chisel or punch to score the edge of the threads to prevent any possibility of the nut coming loose (illustration 18).

- a) Insert the upper hub bolt in from the back of the new Belltech steering knuckle. This needs to be done before the upper ball joint is attached.
- b) Attach the new steering knuckle to the upper and lower

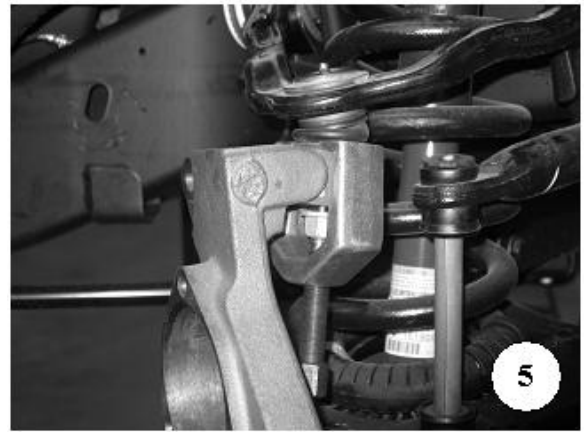

ball joints and loosely thread the nuts in place. **It is helpful to use a jack or lifting device to raise the lower control arm while re-attaching the spindle ball joints. Be very cautious while lifting the lower control arm because it is under extreme load. Make sure the lifting device base is stable and the portion connected to the lower control isn't able to slip out.**

- c) Tighten the upper ball joint nut in place and torque to 37 ft-lbs.
- d) Tighten the lower ball joint (Photo 9). Torque the lower ball joint to 92 ft-lbs for the OEM nut, or 60 ft lb for the supplied thin nut.
- e) Tighten the steering tie rod end to the knuckle and torque to 37 ft-lbs.
- f) Install the backing plate and hub assembly onto the knuckle.
- g) Thread in the three stock hub bolts from the backside of the steering knuckle and torque to 133 ft-lbs (Photo 10).
- h) Install the brake rotor.
- i) Install the brake caliper assembly and torque bolts to 130 ft-lb (Photo 13).

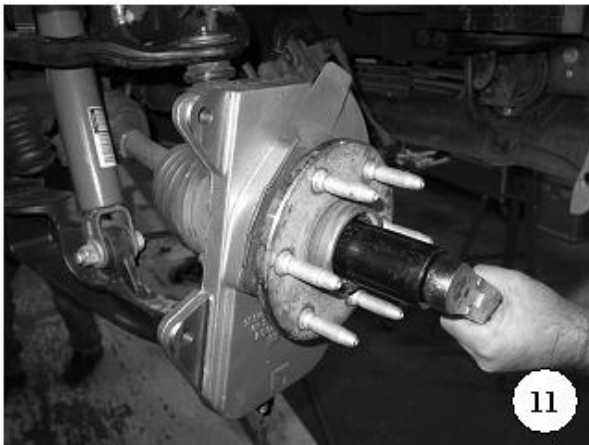
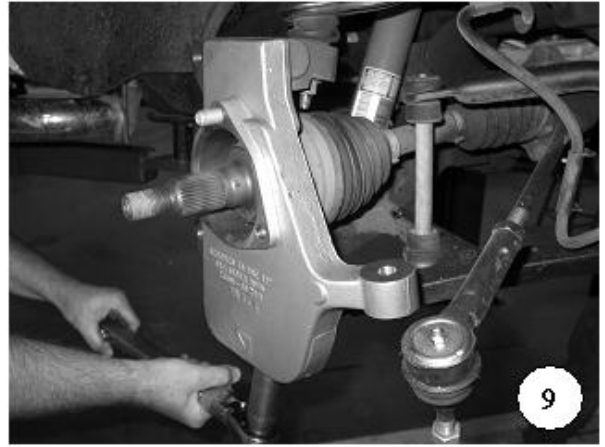

- j) Re-attach the brake line brackets to the top of the steering knuckle and to the control arm. Use the best hole on the spindle for your application. (Photo 14 & 15).
- k) Re-attach the ABS sensor connector and the hold down clips (Photo 14 & 15).
- l) Rotate the steering knuckle in both directions to check if the brake line and ABS cable have enough slack (Photo 15). If one or the other seems to be too tight, then you should pull it thru the bracket to give it the proper amount of slack.



- m) Passenger side installation is complete (Photo 16) follow all the previous steps for the driver's side.

4. Final assembly and adjustments

- a) Check that all components and fasteners have been properly installed, tightened and torqued.
- b) Check brake hoses, and other components for any possible interference.
- c) Reinstall both front wheels and torque lug nuts to correct specification.
- d) Lift vehicle and remove support stands. Carefully lower vehicle to ground.
- e) Test-drive the vehicle in a remote location so that you can become accustomed to the revised driving characteristics and handling. Be aware that the vehicle will handle substantially different now that it has been modified.
- f) We recommend the vehicle be taken in to a qualified wheel alignment facility to be realigned to the following specifications. This should be done after the vehicle has been test driven and all modifications have been completed.

Alignment Specifications

Caster: Factory Specifications +1°

Camber: .50 Min. 0.0 Max. 1.0

Toe-In: .05 Min. 0.00 Max .10

- g) Installation is complete. Check all of the hardware and re-torque at intervals for the first 10, 100, 1000 miles.

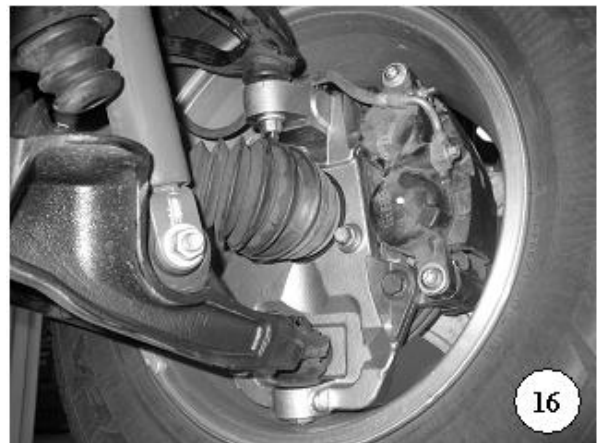

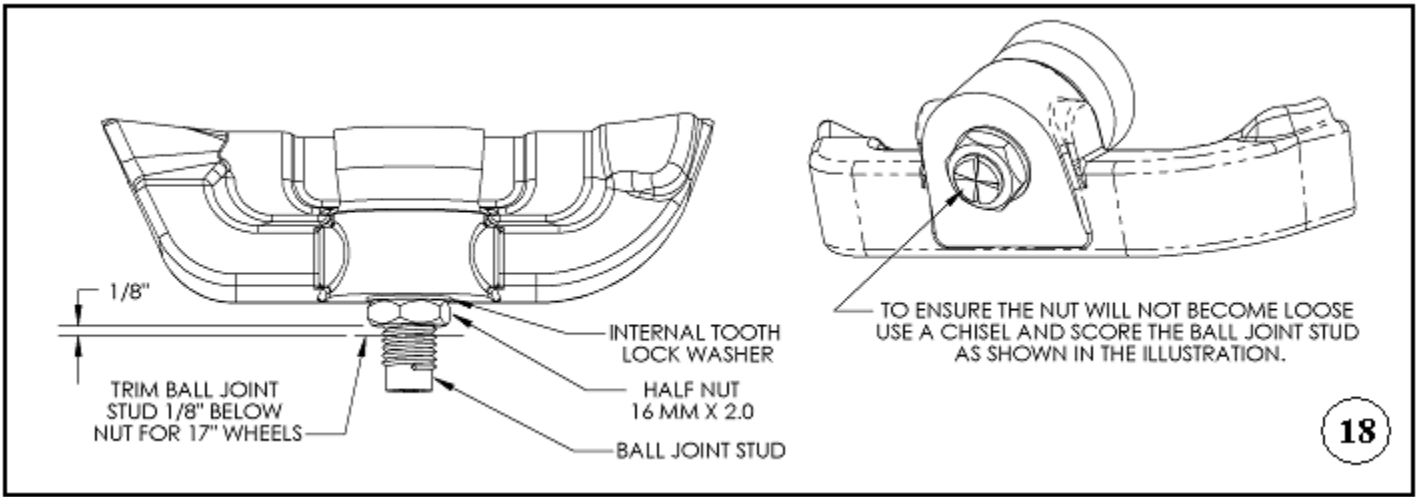

PART LIST FOR 2511 DROP SPINDLE KIT

PART#	DESCRIPTION	QTY
2511-350	Steering Knuckle LH	1
2511-450	Steering Knuckle RH	1
115007	Half Nut 16mm x 2.0	2
115009	Internal Tooth Lock Washer	2