

Supplied Hardware: [8] TRAX slot mounts,
[8] 1/4-20 X 1 1/4" phillips combo head,
[8] 1/4-20 serrated flange nuts, [4] Side towers,
[4] 1/4-20 x 3/4 button head bolts, [4] D-ring tie downs,
[1] 58" Guardrail

BEDSLIDE
GET TO IT.



SIDE KIX

Tools Needed: Phillips screwdriver, 1/8" allen wrench,
7/16 wrench

STEP 1.

ATTACH TOWERS TO SIDE KIX

NOTE: The SIDE KIX are directional so make certain the "BEDSLIDE" logo is facing forward and out!

Align pre-drilled holes inside the bins with the mounting holes on each TOWER. Flat side of the TOWERS must face out. Secure the TOWERS to each SIDE KIX using the supplied 1/4-20 x 1 1/4 Phillips combo head bolts and 1/4-20 serrated flange nuts as illustrated below.

DO NOT OVER TIGHTEN THE HARDWARE!

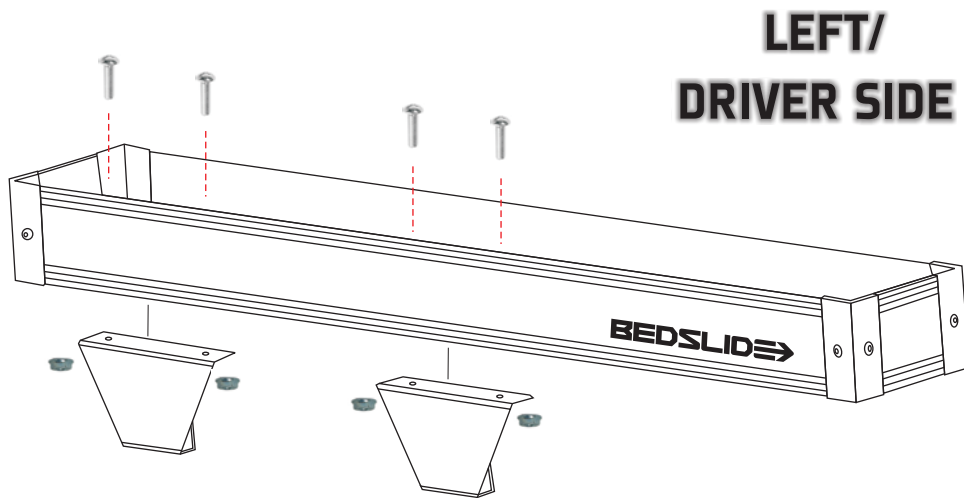

**RIGHT/
PASSENGER SIDE**

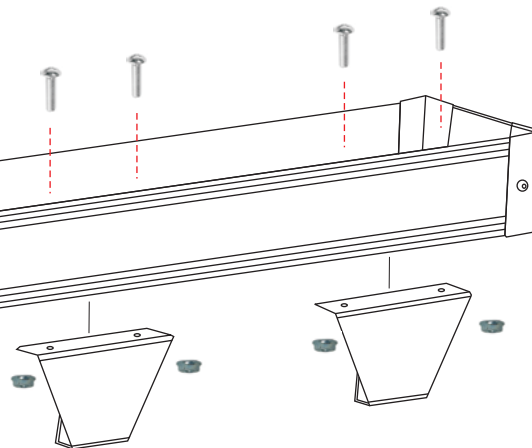

STEP 2.

INSERT (2) MOUNT BLOCKS INTO EACH GUARDRAIL

A. Loosen and remove the 1/4-20 x 5/8 set screw securing the plastic end cap on the ends of each GUARDRAIL. Then loosen and remove the 1/4-20 x 3/4 button head securing the GUARDRAIL to each of the SIDE TOWERS mounted on the BEDSLIDE. **B.** Insert (2) MOUNT BLOCKS into the open end of each GUARDRAIL. **C.** Re-attach GUARDRAIL to the SIDE TOWERS along with the plastic end caps to each side.

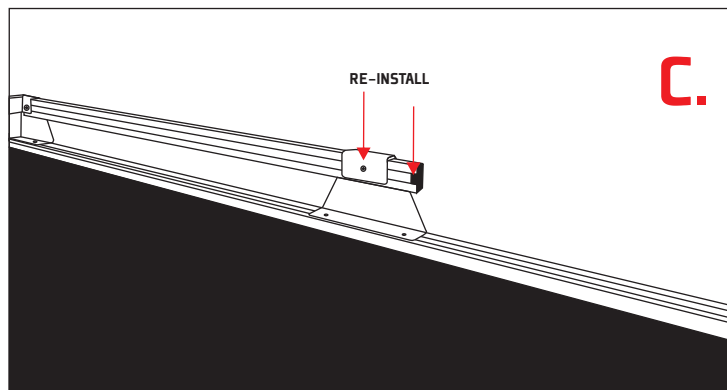
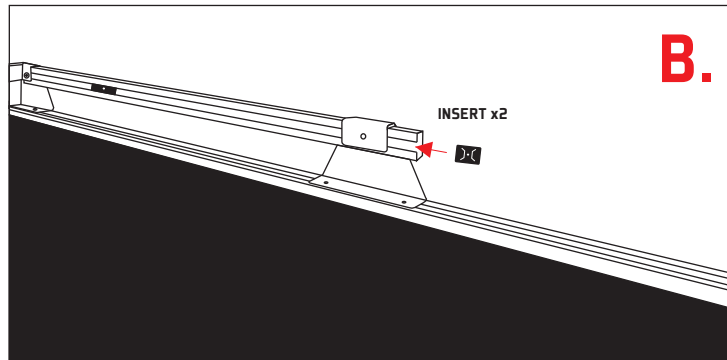
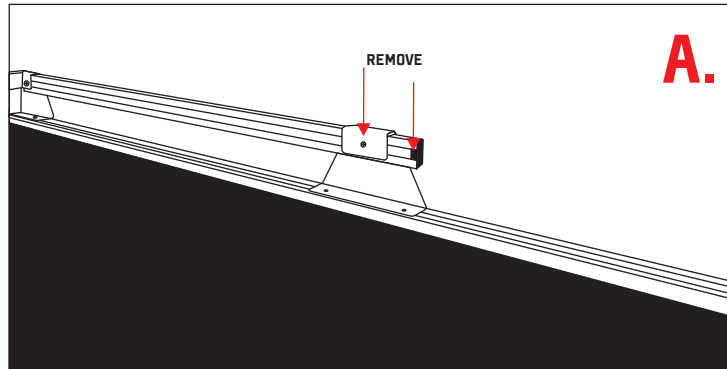

STEP 3.

ATTACH SIDE KIX TO TOWERS

To attach the SIDE KIX, tuck them under the GUARDRAILS on the BEDSLIDE and secure them with a D-ring tie down. Turn the D-rings clockwise into the [2] MOUNT BLOCKS in the rail to tighten them into place. Repeat to the opposite side.

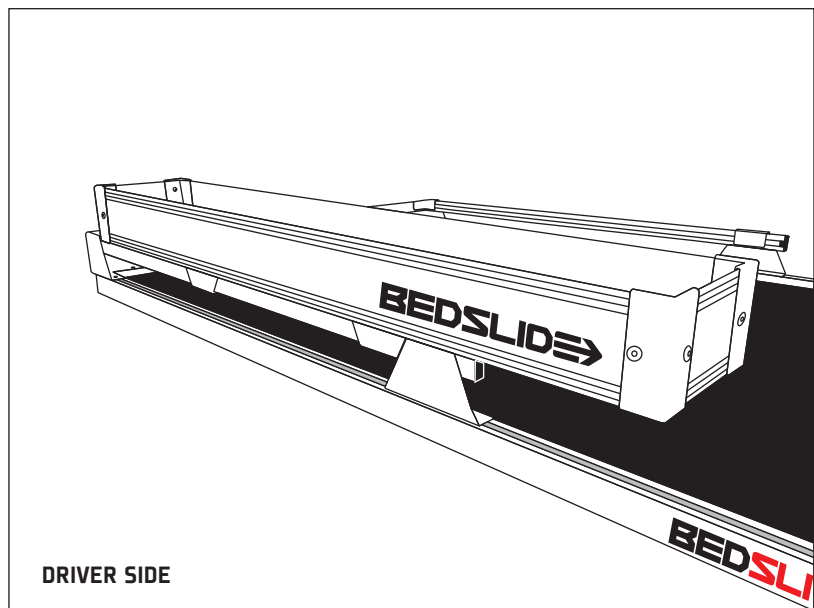
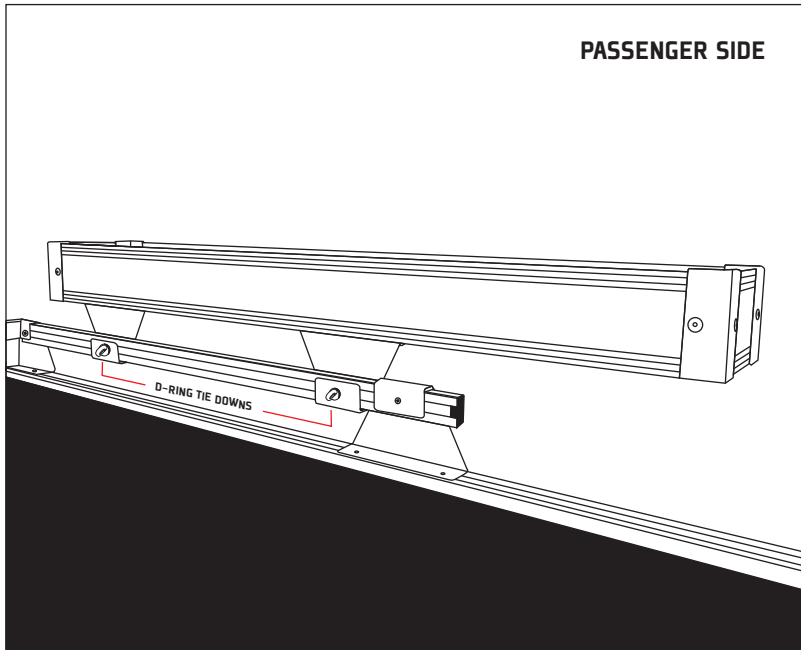

STEP 4.

ATTACH SUPPORT BAR

Insert (2) MOUNT BLOCKS into the rail and position the 48" support bar to the back (cab end) of the SIDE KIX. Insert (2) 1/4-20 x 3/4 button head bolts into the pre-drilled holes located inside the bins and into the MOUNT BLOCKS in the rail. Tighten all (4) 1/4-20 x 3/4 bolts to secure the support bar.

Installation is complete!

