



Installation Instruction:

Product: NDS6223EP

Car Model: 2014-2015 Lexus LS460

Disclaimer:

The navigation and DVD lock while in motion was originally installed for safety reasons. By unlocking the navigation and DVD lock, we are assuming that the navigation and DVD will be controlled and enjoyed by the passenger(s) and not by the driver. As such, are not responsible to damage, loss or injury from using the bypass modules. Please be responsible drivers!

About the Beat-Sonic NAV/DVD Bypass Module:

System: 100% Plug and play kit from Beat-Sonic for allowing use of factory features that would be locked out during vehicle movement.

This plug-and-play module kit allows override of the lock out system equipped in your factory TV or Navigation/DVD system when the vehicle is in motion. Due to the fact that no modification is needed on the factory harness and this is 100% plug and play, it is easily reversible to the original factory specs without showing any signs that this modification was ever made.

The NDS kit provides automatic video in motion for the DVD player at all times. Navigation in motion is activated by the steering wheel volume control buttons by pressing volume up (+), down (-), up (+), down (-) in sequence and at normal cadence. While navigation in motion is activated, the navigation system will temporarily lose its GPS location and the position indicator on the navigation screen will stop moving. By default, a programmable timer will reset the navigation in motion to switch off after 3 minutes.

Navigation in motion can be switched off before the timeout period has expired by repeating the volume control button sequence up (+), down (-), up (+), down (-).

This device is suitable for Lexus generation 7 and 8 navigation systems. The full time video in motion feature is compatible with all navigation system features including Lexus App Suite, Enform App Suite and energy consumption display found on hybrid models.

1. PRECAUTION

CAUTION: After turning the engine switch off, waiting time may be required before disconnecting the cable from the battery terminal. Therefore, make sure to read the disconnecting the cable from the battery terminal notice before proceeding with work

2. REMOVE COWL TOP VENTILATOR LOUVER RH.

(a) Remove the 6 clips and cowl top ventilator louver RH.

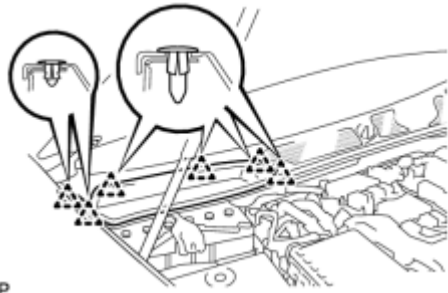

3. DISCONNECT CABLE FROM NEGATIVE BATTERY TERMINAL

NOTICE: When disconnecting the cable, some systems need to be initialized after the cable is reconnected

4. REMOVE INSTRUMENT PANEL FINISH PANEL END LH.

(a) Pull the front part of the instrument panel finish panel end LH to detach the 6 clips.

(b) Pull the instrument panel finish panel end LH to detach 3 clips and remove the instrument panel finish panel end LH.

5. REMOVE INSTRUMENT PANEL FINISH PANEL END RH.

HINT: Use the same procedure described for the LH side.

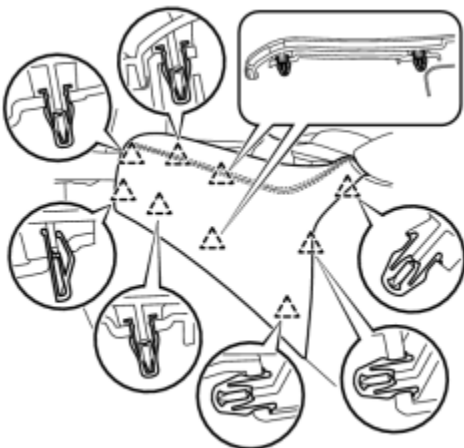

6. REMOVE SHIFT LEVER KNOB SUB-ASSEMBLY.

(a) Lower the shift lever boot and disconnect it from the shift lever knob sub-assembly.

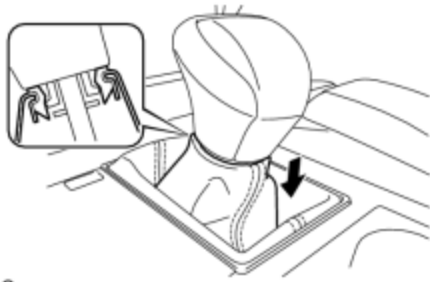

(b) Twist the shift lever knob sub-assembly in the direction indicated by the arrow and remove it.

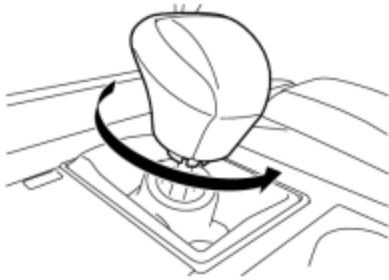

7. REMOVE NO. 3 BOX PANEL.

(a) Detach the 4 claws and remove the No. 3 box panel.

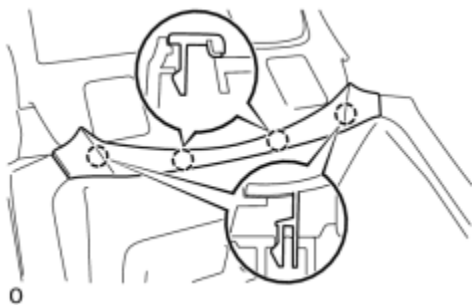

8. REMOVE UPPER REAR CONSOLE PANEL SUB-ASSEMBLY.

(a) Apply protective tape as shown in the illustration.

Text in Illustration : *1 (Protective Tape)

(b) Move the shift lever to N.

(c) Remove the 2 screws.

(d) Detach the 6 clips and remove the upper rear console panel sub-assembly.

(e) Disconnect each connector and each wire harness clamp.

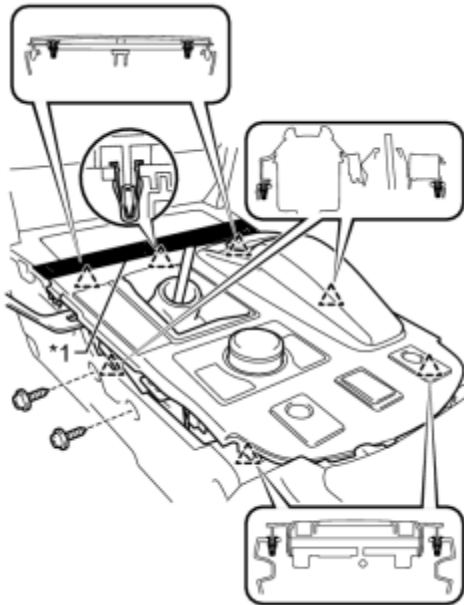

0

9. REMOVE UPPER INSTRUMENT CLUSTER FINISH PANEL.

(a) Apply protective tape as shown in the illustration.

(b) Hold the opposite end with one hand as shown in the illustration so that the clip can be firmly pushed.

(c) Insert a screwdriver at the location shown in the illustration, and then push the lower clip on the backside of the upper instrument cluster finish panel towards the rear of the vehicle to detach it.

NOTICE: At this time, all the clips may become detached and the upper instrument cluster finish panel may suddenly come off. Therefore, slowly push on the clip to detach it.

HINT: Tape the screwdriver tip before use.

- The upper clip of the upper instrument cluster finish panel may become detached at the same time.

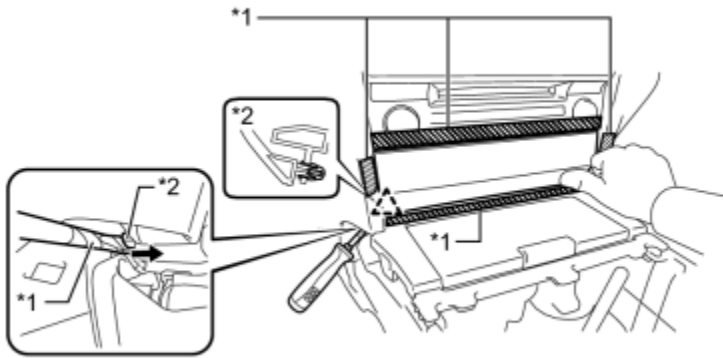

0

Text in Illustration

*1	Protective Tape	*2	Lower Clip
	Rear of the Vehicle		

(d) Insert a screwdriver at the location shown in the illustration, and then push the lower clip on the backside of the upper instrument cluster finish panel towards the rear of the vehicle to detach it.

NOTICE: Slowly push on the clip to detach it.

- At this time, all the clips may become detached and the upper instrument cluster finish panel may suddenly come off. Therefore, place one hand on the upper instrument cluster finish panel as shown in the illustration.

HINT: Tape the screwdriver tip before use.

- The upper clip of the upper instrument cluster finish panel may become detached at the same time.

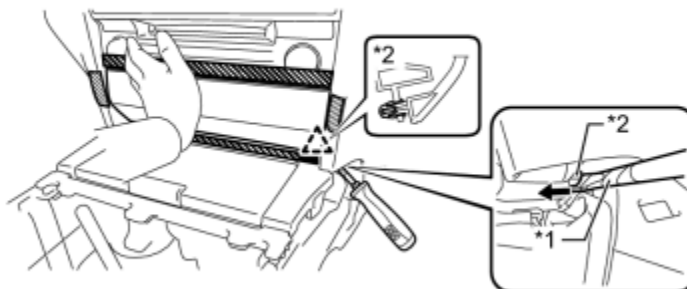

0

Text in Illustration

*1	Protective Tape	*2	Lower Clip
➔	Rear of the Vehicle	-	-

(e) Insert moulding remover A between the upper instrument cluster finish panel and lower No. 1 instrument panel finish panel, and between the upper instrument cluster finish panel and lower No. 2 instrument panel finish panel to detach the 3 upper clips and remove the upper instrument cluster finish panel.

NOTICE: If pressure is applied to the edge of the upper instrument cluster finish panel using molding remover A, the surface may be damaged. Therefore, insert molding remover A deep past the edge of the upper instrument cluster finish panel to detach the clips.

Text in Illustration

*1	Protective Tape
■	Upper Instrument Cluster Finish Panel Edge

HINT: If any of the upper clips have become detached during the previous procedure, detach the remaining clips to remove the upper instrument cluster finish panel.

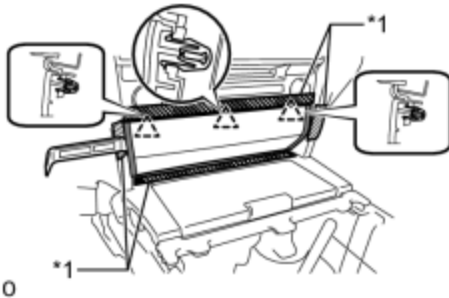

10. REMOVE UPPER CONSOLE PANEL SUB-ASSEMBLY.

- (a) Disconnect the connector.
- (b) Detach the 6 clips and remove the upper console panel sub-assembly.

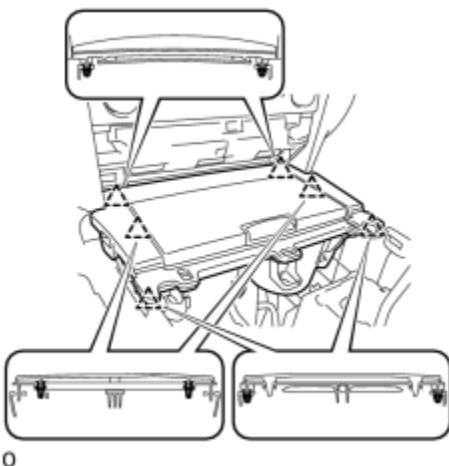

11. REMOVE LOWER NO. 2 INSTRUMENT PANEL FINISH PANEL.

(a) Detach the 4 clips and 5 guides and remove the lower No. 2 instrument panel finish panel.

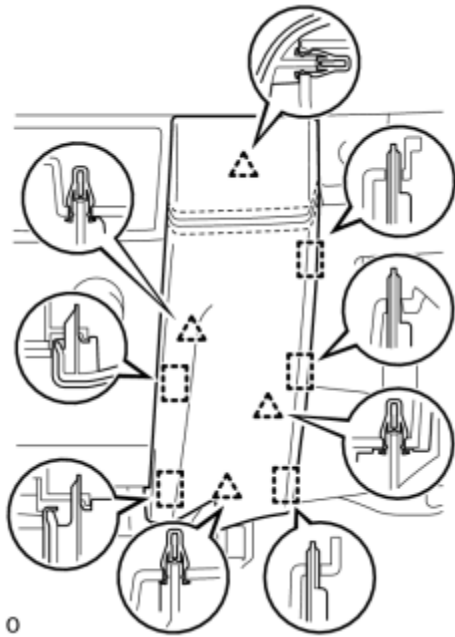

12. REMOVE LOWER NO. 1 INSTRUMENT PANEL FINISH PANEL.

(a) Detach the 4 clips and 5 guides and remove the lower No. 1 instrument panel finish panel.

(b) Disconnect the connector.

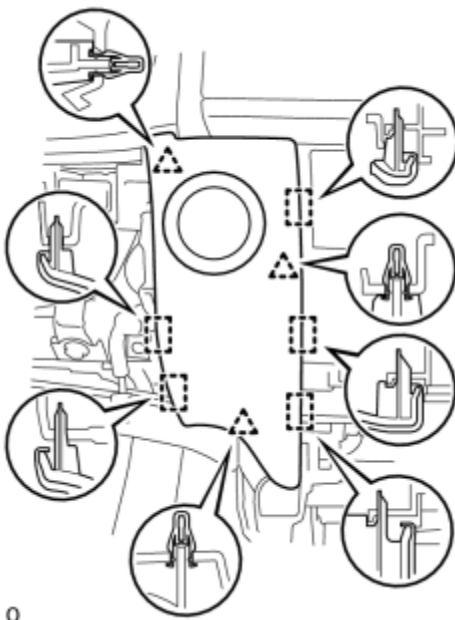

13. REMOVE MULTI-MEDIA MODULE RECEIVER ASSEMBLY.

(a) Remove the 2 bolts.

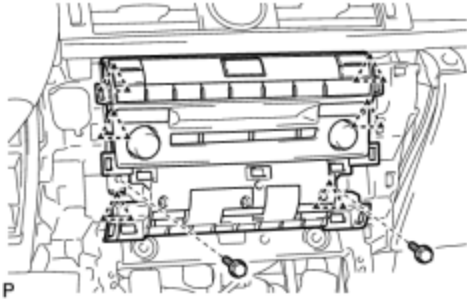

HINT: Grab a towel and rest the radio between the towel and center console to avoid scratching interior pieces.

14. REMOVING THE CONNECTOR.

(a) The connector circled in red is what you will be working on.



(b) Take a flat head screw driver to release the clip on the right side of the connector.

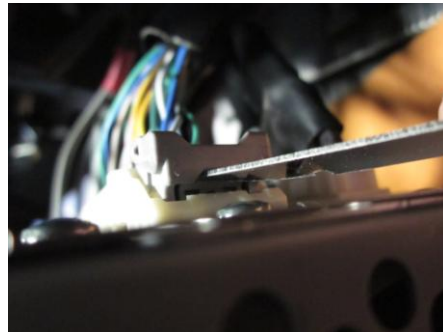

Then pull the connector out.

(c) Carefully remove the gray bracket, which is being used to keep the three connectors together.

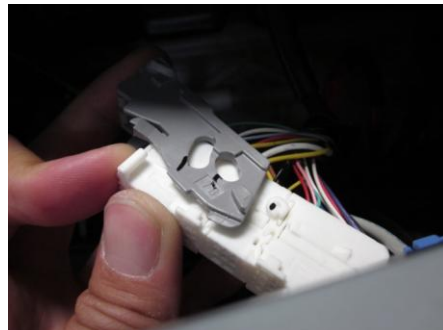

(d) After the gray bracket is removed, the connector should look like this. The right side of the connector is what you need to disconnect from the main connector.

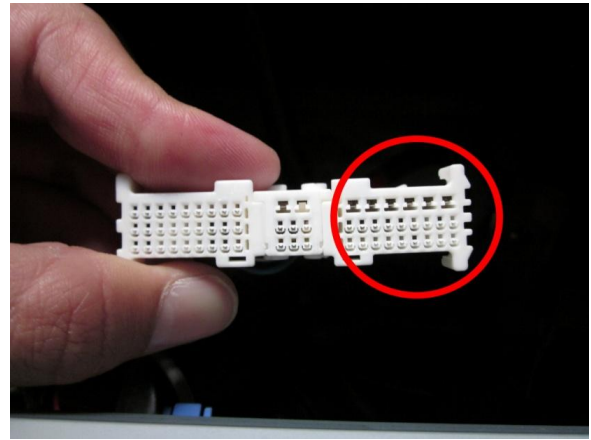

(e) Connect the male side of the NDS6223EP connector to the female connector which was disconnected from the previous step. Make sure the connection is secure and that none of the pins are exposed on the side.

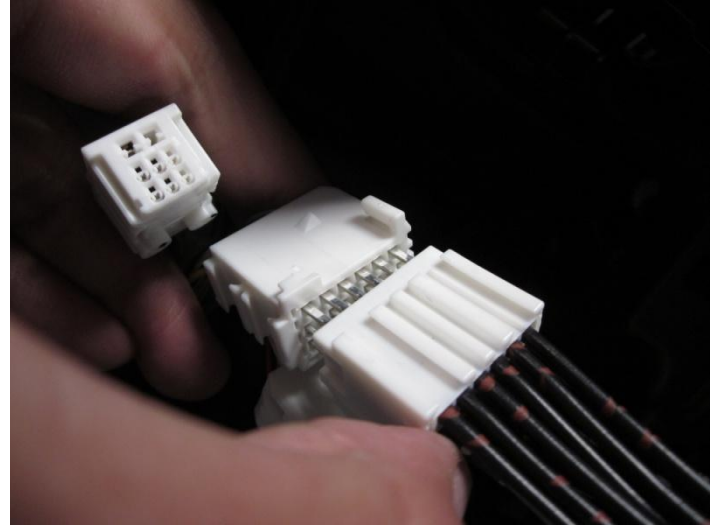

(f) Take the female side of the NDS6223EP connector and link it back to the main connector, then mount the gray bracket back to the main connector.



(g) Once the main connector is in one piece with the gray bracket, insert it back to behind the oem head unit.

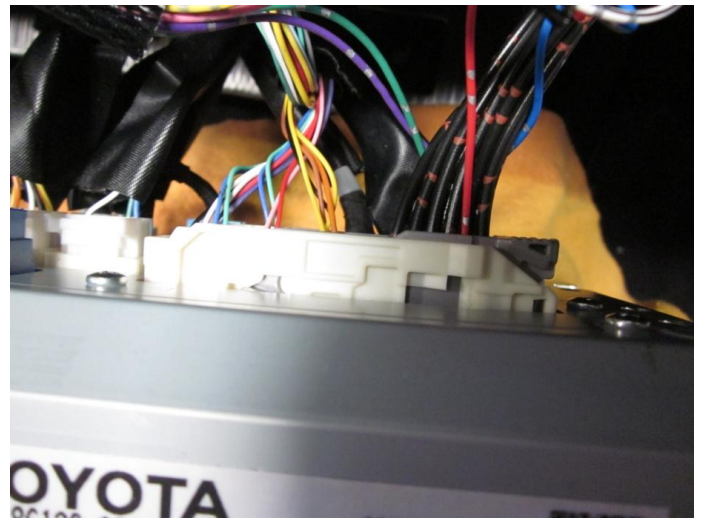

15. The GPS Connector.

- 2014-2015 Lexus LS owners: Please do not use the 1-pin connectors on the NDS6223EP. GPS on the 2014-2015 LS models does not engage the safety lockout feature. Wrap the 1-pin connectors on the NDS6223EP individually by using the electric tape and isolate them to avoid any unwanted contacts with other wires or connectors.

16. The steering wheel connector.

- Locate the matching connector behind the OEM head unit as shown on the photo.

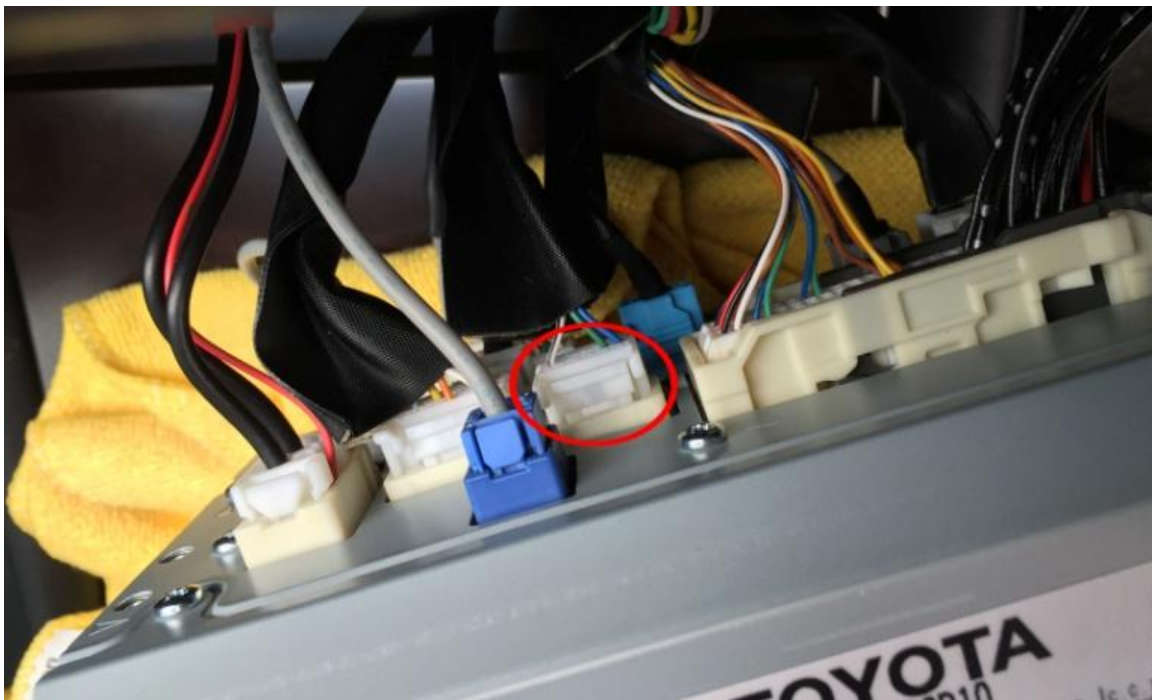

- Disconnect the steering wheel control connector.

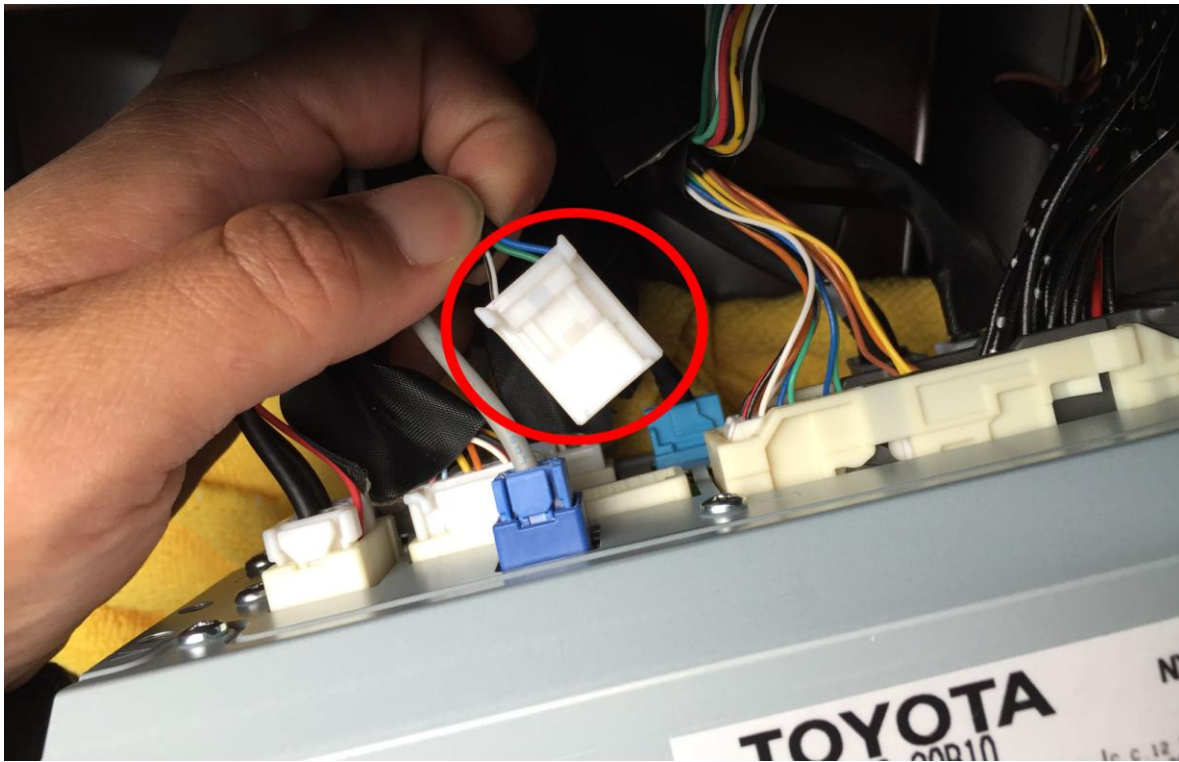

- Connect the matching connector on the NDS6223EP to the factory steering wheel control connector what you just disconnected from the head unit.

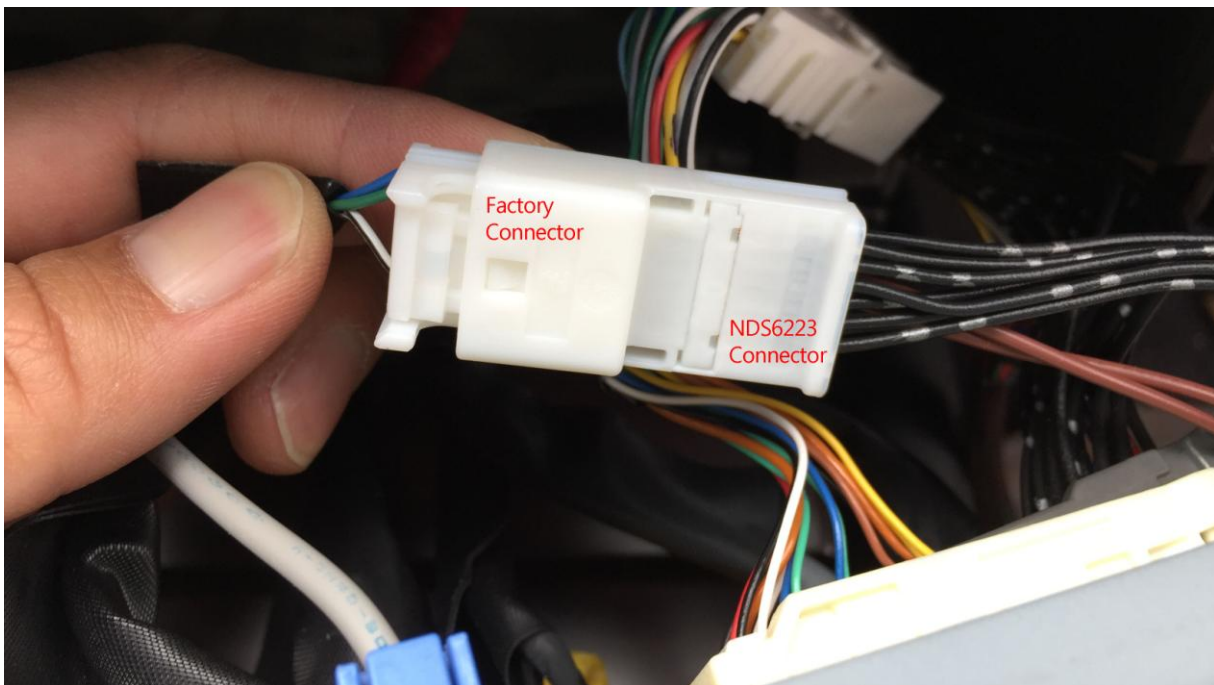

- Connect the other side of the NDS6223EP connector to the factory head unit.

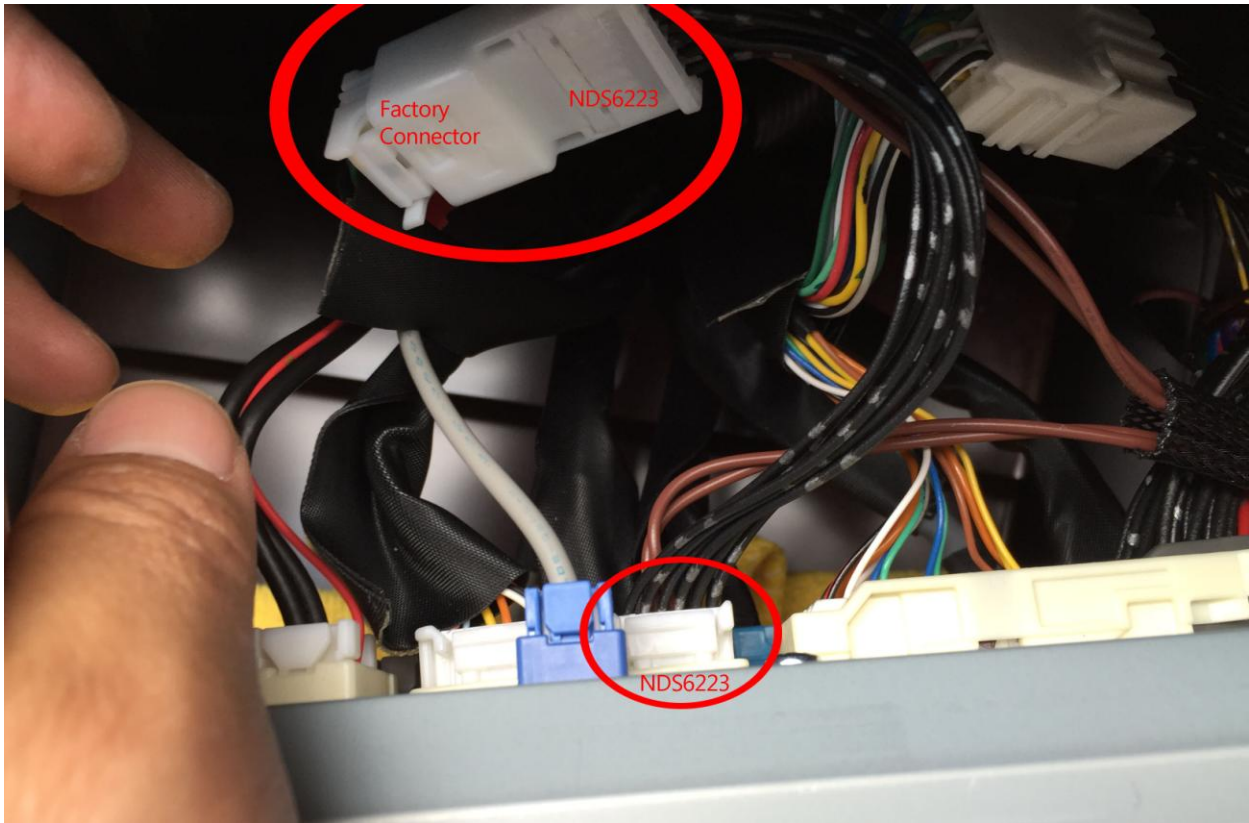

Programming the switch

The default setting of the NDS6223EP is programmed to turn off automatically after 3 min. Please read the enclosed programming instruction (found inside the retail box) and program the switch to your desired setting.

TEST THE UNIT AND REVERSE PROCESS: Test the unit to make sure it is working well. Then, perform the above steps in reverse to put everything back to normal and you are done.