



Part#: 013003

Product: **Extended Radius Arm Kit**

Application: **F100, F150, Bronco**

READ AND UNDERSTAND ALL INSTRUCTIONS AND WARNINGS PRIOR TO INSTALLATION OF SYSTEM AND OPERATION OF VEHICLE.

SAFETY WARNING BDS Suspension Co. recommends this system be installed by a professional technician. In addition to these instructions, professional knowledge of disassembly/ reassembly procedures and post installation checks must be known.

PRODUCT SAFETY WARNING Certain BDS Suspension products are intended to improve off-road performance. Modifying your vehicle for off-road use may result in the vehicle handling differently than a factory equipped vehicle. Extreme care must be used to prevent loss of control or vehicle rollover. Failure to drive your modified vehicle safely may result in serious injury or death. BDS Suspension Co. does not recommend the combined use of suspension lifts, body lifts, or other lifting devices.

You should never operate your modified vehicle under the influence of alcohol or drugs. Always drive your modified vehicle at reduced speeds to ensure your ability to control your vehicle under all driving conditions. Always wear your seat belt.

PRE-INSTALLATION NOTES

1. Special literature required: OE Service Manual for model/year of vehicle. Refer to manual for proper disassembly/ reassembly procedures of OE and related components.
2. Adhere to recommendations when replacement fasteners, retainers and keepers are called out in the OE manual.
3. Larger rim and tire combinations may increase leverage on suspension, steering, and related components. When selecting combinations larger than OE, consider the additional stress you could be inducing on the OE and related components.
4. Post suspension system vehicles may experience drive line vibrations. Angles may require tuning, slider on shaft may require replacement, shafts may need to be lengthened or trued, and U-joints may need to be replaced.
5. Secure and properly block vehicle prior to installation of BDS Suspension components. Always wear safety glasses when using power tools.
6. If installation is to be performed without a hoist, BDS Suspension Co. recommends rear alterations first.
7. Due to payload options and initial ride height variances, the amount of lift is a base figure. Final ride height dimensions may vary in accordance to original vehicle attitude. Always measure the attitude prior to beginning installation.

POST-INSTALLATION WARNINGS

1. Check all fasteners for proper torque. Check to ensure for adequate clearance between all rotating, mobile, fixed, and heated members. Verify clearance between exhaust and brake lines, fuel lines, fuel tank, floor boards and wiring harness. Check steering gear for clearance. Test and inspect brake system.
2. Perform steering sweep to ensure front brake hoses have adequate slack and do not contact any rotating, mobile or heated members. Inspect rear brake hoses at full extension for adequate slack. Failure to perform hose check/ replacement may result in component failure. Longer replacement hoses, if needed can be purchased from a local parts supplier.
3. Perform head light check and adjustment.
4. Re-torque all fasteners after 500 miles. Always inspect fasteners and components during routine servicing.

PARTS LIST

Description	Qty
Radius Arm Brackets (RH/LH)	2
<i>Bolt Pack</i>	
1/2" x 1-1/2" Bolt	12
1/2" Torque Nut	12
1/2" Flat Washers	24
Radius Arm (RH/LH)	2
Axle Pivot Brackets (RH/LH)	2
Driver's Side Hardware: Re-use OEM	
<i>Passenger's Side Hardware:</i>	
9/16" x 3-1/2" Bolt	1
9/16" Torque Nut	1
9/16" Flat washer	2
1/2" x 1-1/2" Bolt	2
1/2" Torque Nut	2
1/2" Flat washer	4
Pitman Arm	1
Small Radius Arm Bushing	2
Large Radius Arm Bushing	2
<i>Radius Arm Hardware:</i>	
3/4" Torque Nut	2
3/4" Flat Washer	2
7/8" Flat Washer	2

SPECIAL TOOLS & LITERATURE

1. High Quality Jack Stands
2. Air Chisel/Drill/Torches (for removing OEM rivets from the frame)
3. SAE and Metric wrenches
4. OEM service manual for the year/application of the vehicle

SPECIAL NOTE FOR BRONCO:

Measure the vehicle wheelbase before beginning the suspension installation and record here _____. The wheel base is the distance from the center of the front axle to the center of the rear axle (hub-to-hub). This measurement should be approximately 105".

FRONT SYSTEM INSTALLATION

1. Lift the vehicle using hydraulic jacks or equivalent and then support the vehicle with jack stands. Be sure the jack and stands gives adequate access the OEM radius arm brackets.
 2. Remove the wheels and tires from the vehicle.
 3. Disconnect the anti-sway bars at the frame, if present.
- ⓘ *Note: If the vehicle has anti-sway bars you will need BDS Part # 123401 anti-sway bar extension kit. Disconnect steering linkage from pitman arm at this time using a pickle fork.*
4. Place hydraulic jacks under the radius arms in order to remove the OEM radius arm brackets. Remove the OEM rivets and bolts attaching the radius arm bracket to the frame. [Fig. 1]
 5. Lower the brackets and remove the radius arm bushings, nut, and OEM bracket.
 6. Remove the front shock absorbers. [Fig. 2]



Fig 1

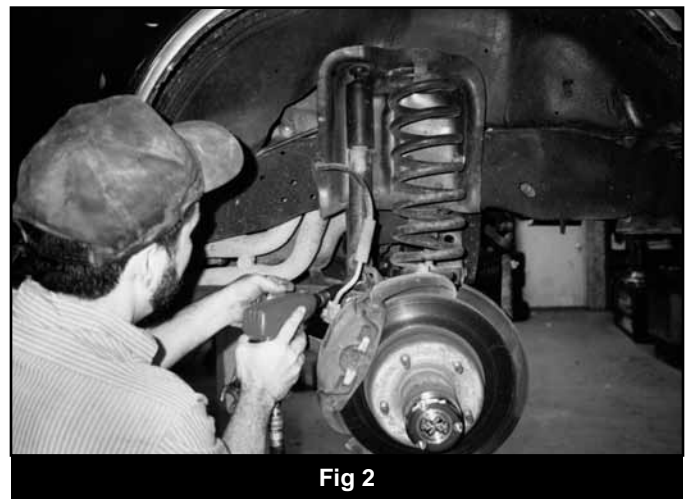

Fig 2

7. Place hydraulic jacks under the axles. Adjust jacks until the coil springs are not under compression. Remove the upper coil spring retaining J-Clip from the tower. **⚠ Caution: Do not stretch brake hoses.** BDS recommends replacement of OE brake hoses with extended length brake hoses that will allow full axle droop. Lower the assembly and remove the lower retaining nut and cup washer. Remove the coil spring from seat. Reference the BDS coil spring instruction sheet for additional information on coil spring removal and installation.

8. Remove the OE bolt retaining the radius arm to the axle. Install supplied BDS radius arm and retain using OE bolt. Torque to OE specification.

ⓘ Note: The BDS radius arm should be installed so that the shock tabs are facing upward and the radius arms are bent inward for tire clearance.

9. Attach the BDS radius arm mounting brackets to the BDS radius arms using the provided bushings and hardware. Tighten radius arm nuts until bushings begin to swell. [Fig. 3]

ⓘ Special Note for Bronco:

The relationship between the new radius arm bracket and the body mount illustrated in Fig 6 varies on some Broncos. Use the existing hole in the frame rail (noted in #10) to attach the new mounting bracket to the frame. Do not drill new holes at this time. Tighten the 1/2" bolt in the existing hole. When the front and rear install is complete, the bracket will be located to its final mounting place.

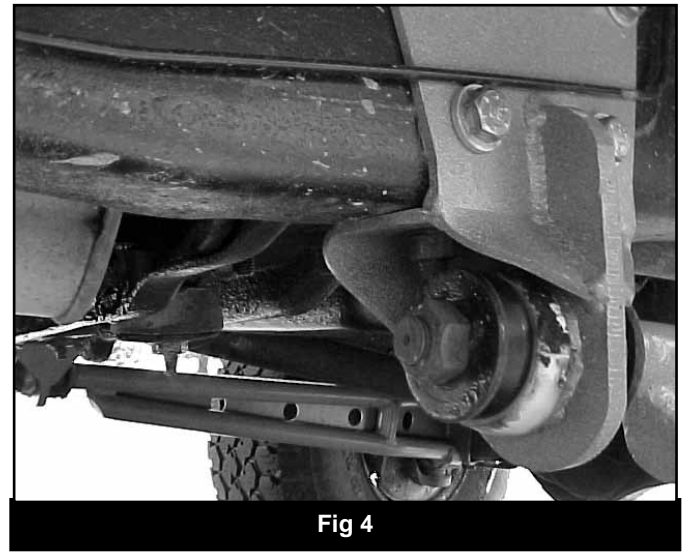
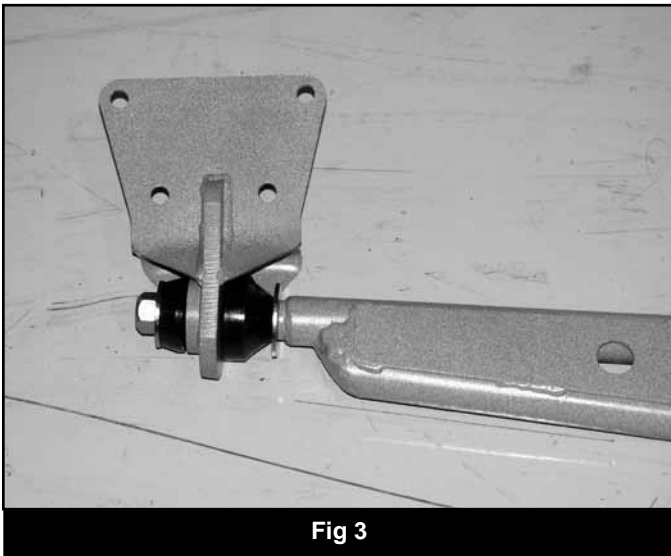

10. Raise bracket into position on the frame and secure with the 1/2" fasteners.

ⓘ Note: The rear bottom hole in the BDS mounting bracket should line up with the hole in the bottom of the frame rail where the OE crossmember attaches. This crossmember is not always in the same location on all vehicles. When in doubt use figure 5 to locate the new bracket back from the body mount. [Fig. 4, 5, & 6] Be sure all bolts are installed before tightening. Using the holes in the brackets as drill guides, drill the remaining 1/2" holes in the frame to install the additional 1/2" fasteners and tighten.

⚠ Warning: Always use caution when drilling through the frame to insure that no interference occurs with brake and fuel lines or wiring. Tighten radius arm bushing nuts to OEM specification.

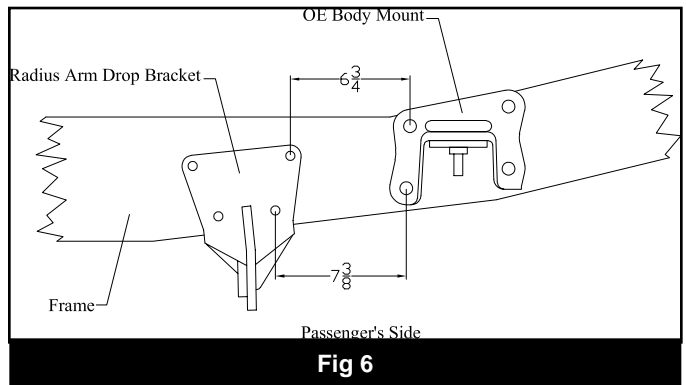
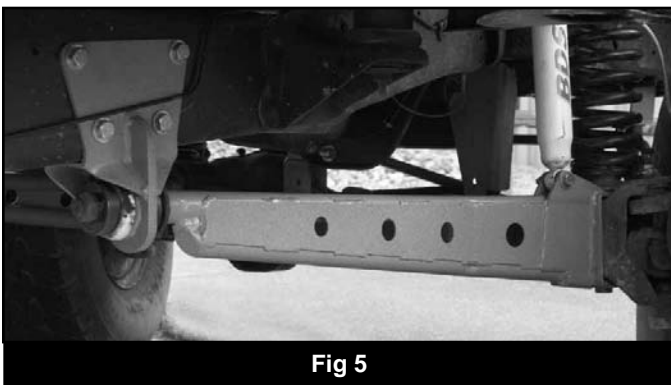

11. Place new BDS Coil Spring (4" or 6" lift coil spring) onto spring seat and secure with OEM fasteners. Raise assembly into the upper spring tower and secure with the OEM clip. [Fig. 7]

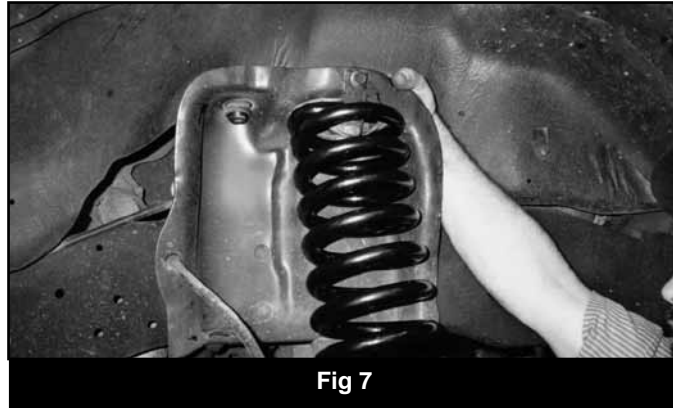

12. Remove the bolts from the passenger side axle pivot bracket, (located on the driver side). Note: Slowly lower the axle so as not to push the jack out from under the axle. Allow the axle to hang in the center of the vehicle. Install the smaller axle pivot drop bracket into the OEM frame pocket. Align Bracket straight up and down and secure with the 9/16" fasteners. Using the holes as drill guides, drill 1/2" holes in crossmember and secure with the additional 1/2" fasteners. It may be easier to blow a starting hole with a plasma cutter to avoid the blind hole drilling situation. Secure the axle to the bracket with the OEM fasteners, but do not torque to specification at this time.

 *Note: If 4" coil springs are installed then attach the axle to the hole in the drop bracket farthest from the ground (top hole). If 6" coils are installed then attach to the hole closest to the ground (bottom hole). [Fig. 8]*

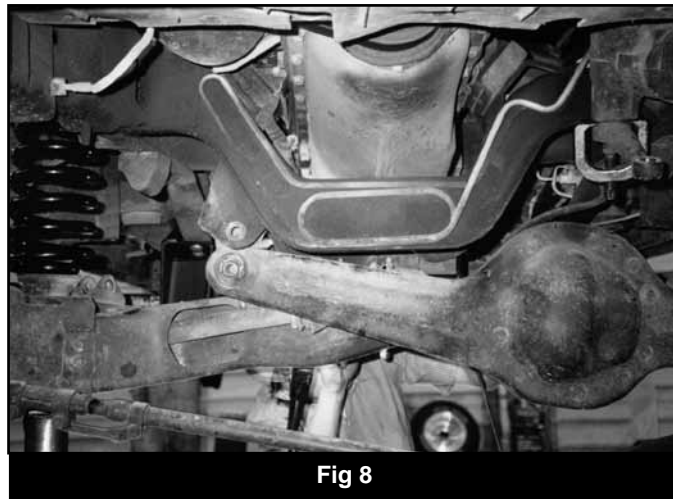

13. Remove driver side axle pivot bracket (located on passenger side). Install the larger BDS axle pivot bracket and attach using OEM fasteners and secure to OEM Specification. Attach the axle to the BDS bracket using the OEM fasteners in the hole appropriate of the coil spring being used. Tighten, but do not torque to specification at this time.
14. We recommend installing BDS Bump Stop Extensions Part #129000 (ordered separately) at this time.
15. If front anti-sway bar is present, then install BDS sway-bar extension kit #123401 (ordered separately) at this time. Install bracket to frame using the 3/8" fasteners, do not tighten at this time. Attach the OEM sway bar bracket to the extension bracket and tighten all fasteners to specification.
16. Remove the OEM pitman arm using an appropriate puller. Install new BDS pitman arm and torque to specification. Attach steering linkage to the pitman arm and torque according to OEM specification. Be sure to install new cotter key. [Fig. 9]

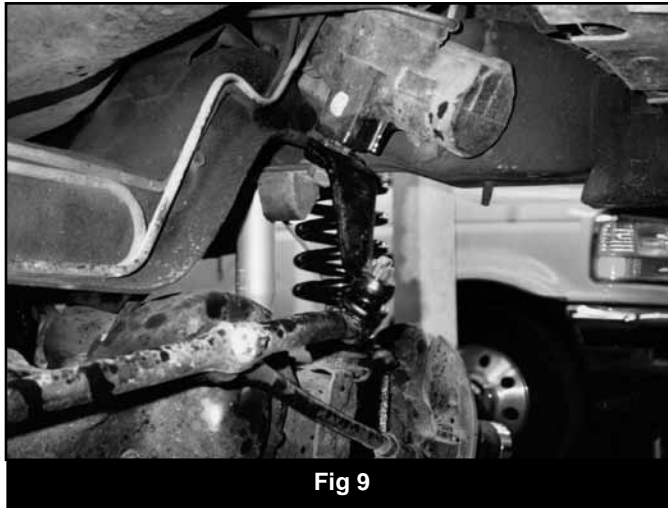

Fig 9

17. Remove the upper shock bushings from the spring towers. Note: The upper OEM bushing can be left in, if the shaft diameter of the aftermarket shock is the same as the OEM shock.
18. Install applicable BDS shocks for your vehicle and amount of lift. Install wheels and tires. [Fig. 10]

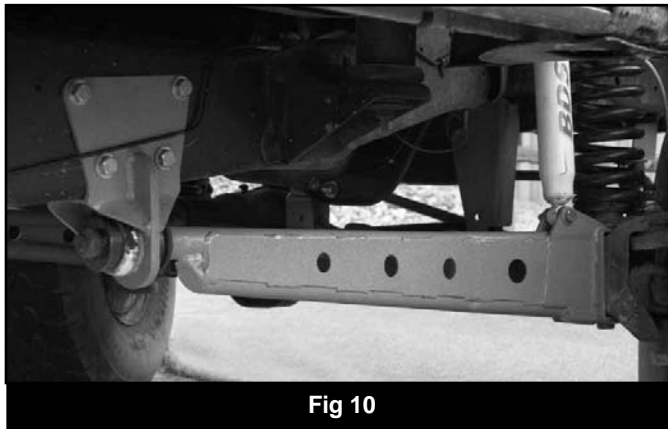

Fig 10

19. Install the desired BDS rear lift system at this time.

Special Note for Bronco:

With the front and rear installation complete, set the vehicle on the ground and roll it back and forth to settle the suspension. Check the wheel base measurements to those taken at the beginning of the installation. If the measurements are equal (within 1/2") the axle is in the correct position and the radius arm bracket installation can be completed as instructed in #10. If the measurements are not equal (usually short by 1" to 1-1/2") the radius arm brackets will need to be relocated to obtain the correct wheel base measurements. Follow the drilling instructions in #10 after properly locating the brackets to the new position to match the wheel base measurement. The bottom hole in the frame will have to be drilled in the new position.

20. Lower the vehicle to the ground. Torque axle pivot fasteners to specification at this time. Double check all fasteners for proper torque at this time.
21. Adjust headlights as needed.
22. Align front end to OEM alignment specifications before operating.
23. Be sure to check all fasteners and the alignment after 500 miles operation.

Supplied Fasteners	Torque Specification
1/4" Fasteners	17 ft lbs
3/8" Fasteners	30 ft lbs
7/16" Fasteners	55 ft lbs
1/2" Fasteners	75 ft lbs