

# Installation instructions



Part#: 021627



## 7" High Clearance Suspension System

Chevy/GMC 2500 & 3500 HD 2WD | 2001-2010



# Read And Understand All Instructions And Warnings Prior To Installation Of System And Operation Of Vehicle.

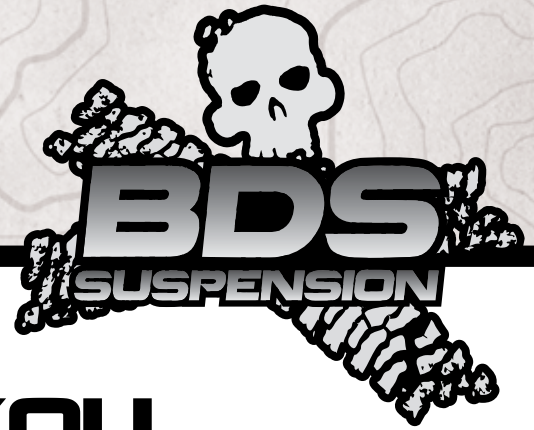

## THANK YOU

Your truck is about to be fitted with the best suspension system on the market today. That means you will be driving the baddest looking truck in the neighborhood, and you'll have the warranty to ensure that it stays that way for years to come. Thank you for choosing BDS Suspension!

### BEFORE YOU START

BDS Suspension Co. recommends this system be installed by a professional technician. In addition to these instructions, professional knowledge of disassembly/ reassembly procedures and post installation checks must be known.

### FOR YOUR SAFETY

Certain BDS Suspension products are intended to improve off-road performance. Modifying your vehicle for off-road use may result in the vehicle handling differently than a factory equipped vehicle. Extreme care must be used to prevent loss of control or vehicle rollover. Failure to drive your modified vehicle safely may result in serious injury or death. BDS Suspension Co. does not recommend the combined use of suspension lifts, body lifts, or other lifting devices. You should never operate your modified vehicle under the influence of alcohol or drugs. Always drive your modified vehicle at reduced speeds to ensure your ability to control your vehicle under all driving conditions. Always wear your seat belt.

### BEFORE INSTALLATION

Special literature required: OE Service Manual for model/year of vehicle. Refer to manual for proper disassembly/reassembly procedures of OE and related components.

Adhere to recommendations when replacement fasteners, retainers and keepers are called out in the OE manual.

Larger rim and tire combinations may increase leverage on suspension, steering, and related components. When selecting combinations larger than OE, consider the additional stress you could be inducing on the OE and related components.

Post suspension system vehicles may experience drive line vibrations. Angles may require tuning, slider on shaft may require replacement, shafts may need to be lengthened or trued, and U-joints may need to be replaced.

Secure and properly block vehicle prior to installation of BDS Suspension components. Always wear safety glasses when using power tools.

If installation is to be performed without a hoist, BDS Suspension Co. recommends rear alterations first.

Due to payload options and initial ride height variances, the amount of lift is a base figure. Final ride height dimensions may vary in accordance to original vehicle attitude. Always measure the attitude prior to beginning installation.

### TIRES AND WHEELS

#### FITMENT GUIDE

##### **7" Lift 2001-07 Classic Body Style**

35x12.50 on 16x8 with 4.5" backspacing  
37x12.50 on 17/18x9 with 5" backspacing - narrow track  
37x12.50 on 17/18x9 with 5.5" backspacing - standard  
37x12.50 on 20x9 with 5.75" backspacing

##### **7" Lift 2007-10 New Body Style**

35x12.50 on 17/18x9 with 5" backspacing - narrow track  
35x12.50 on 17/18x9 with 5.5" backspacing - standard  
35x12.50 on 20x9 with 5.75" backspacing

### BEFORE YOU DRIVE

Check all fasteners for proper torque. Check to ensure for adequate clearance between all rotating, mobile, fixed, and heated members. Verify clearance between exhaust and brake lines, fuel lines, fuel tank, floor boards and wiring harness. Check steering gear for clearance. Test and inspect brake system.

Perform steering sweep to ensure front brake hoses have adequate slack and do not contact any rotating, mobile or heated members. Inspect rear brake hoses at full extension for adequate slack. Failure to perform hose check/ replacement may result in component failure. Longer replacement hoses, if needed can be purchased from a local parts supplier.

Perform head light check and adjustment.

Re-torque all fasteners after 500 miles. Always inspect fasteners and components during routine servicing.

# CONTENTS OF YOUR KIT



## 021627

Part #	Qty	Description
02190B	1	Front Crossmember
02100B	2	Brace Tube
02197B	1	Torsion Bar Brkt - Drv
02198B	1	Torsion Bar Brkt - Pass

## 021628

Part #	Qty	Description
02191B	1	Rear Crossmember
B1071	1	Bag Kit
544	1	Bolt Pack
02196	2	Aluminum Spacer
571	1	Bolt Pack
342701	1	Loctite
099000	6	Zip Tie
02199B	2	Front Bump Stop
M02096-BK	2	Bump Stop
575	1	Bolt Pack
01196B	2	Rear Bump Stop
422	1	Bolt Pack
911109	2	Sway Bar Link
B657	1	Bag Kit - Sway Bar Kit
02102B	2	Sway Bar Link Brkt
SB35BK	2	Bushing
SB26BK	4	Bushing
54587	2	Sleeve
S10076	4	Washer
569	1	Bolt Pack

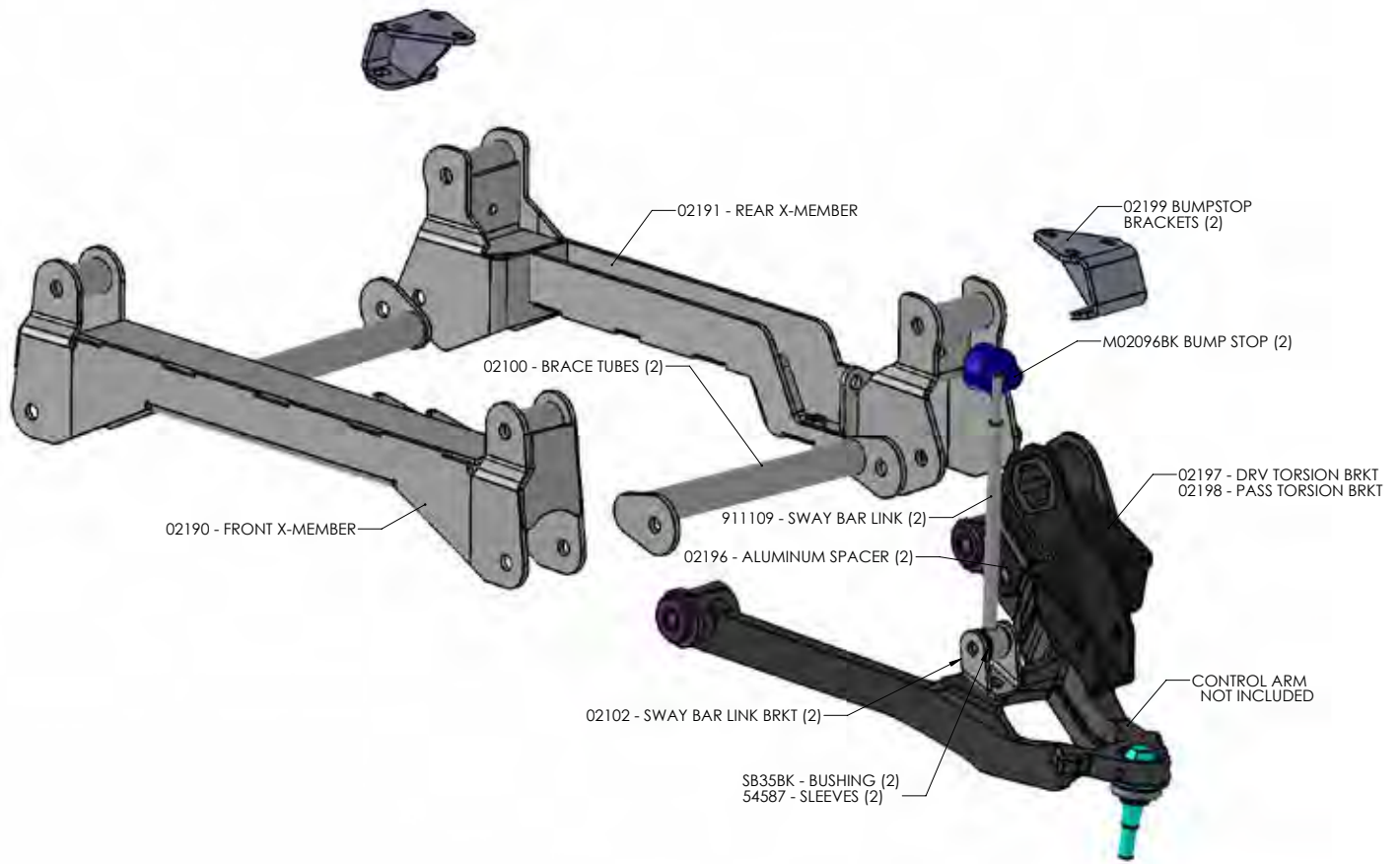

## TECH TIPS

### TROUBLESHOOTING INFORMATION FOR YOUR VEHICLE

1. 20" wheels with 5-5-3/4" backspacing recommend to reduce trimming.
2. Traction bars will not fit standard cab short box models and are designed to work on vehicles with 4-8" of lift.
3. Narrow track knuckle will slightly increase turning radius.
4. For tail high stance use 119157 add-a-leaf with the block kit or 069207 with leaf spring kit.
5. Dually applications will require custom u-bolts.

## INSTALLATION INSTRUCTIONS

### INSTALLATION INSTRUCTIONS

1. Park the vehicle on a flat, clean surface and block the rear wheels for safety.
2. Disconnect the positive and negative battery cables.

#### FRONT INSTALLATION

1. Raise the front of the vehicle and support with jack stands under the frame rails.
2. Remove the wheels.

### SPECIAL TOOLS

Torsion Bar Unloading Tool  
 Reciprocating Saw  
 Welder

3. Measure and record the length of the exposed thread on the torsion bar adjuster bolts (Fig 1). Record the lengths here for use later during the installation

DRV Side: \_\_\_\_\_ PASS Side: \_\_\_\_\_

**FIGURE 1**



4. Unload the torsion bars but do not remove. Save adjuster bolt/retainer block.
5. Mark the unloaded torsion bars to indicate DRV side and PASS side. Also mark the bars to indicate front versus rear.
6. Remove the torsion bar adjuster plate by pushing the torsion bar forward to allow the plate to drop free. On most vehicles this will require a using a hammer/punch or air hammer. Access the end of the torsion bar through the hole in the back of the torsion bar crossmember and drive forward. Leave the torsion bars in the lower control arms.



**Tip**

*Torsion bars are under extreme pressure. A proper torsion bar tool is necessary to unload the bars. A tool designed specifically for GM torsion bars (#J36202 or equivalent) is required. Most auto parts store will lend these tools for little or no charge.*

7. Remove the two bolts that attach the torsion bar crossmember to the frame rails (Fig 2). Remove the torsion bar crossmember from the vehicle. Save bolts and crossmember.

**FIGURE 2**



8. Remove the torsion bars by pulling them rearward out of the lower control arms. Set the torsion bars aside.
9. Remove the front plastic splash guard, save splash guard bolts. If equipped, remove the four bolts mounting the factory belly pan to the frame (Fig 3) These will not be reused.



**FIGURE 3**

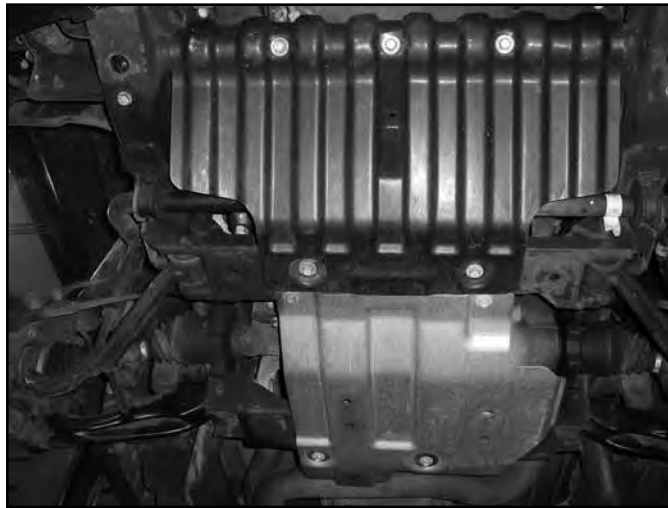

10. Disconnect the sway bar end links from the sway bar and the lower control arms (Fig 4). Discard the link assemblies.
11. Disconnect the tie rod ends from the steering knuckles. Remove the tie rod end nuts and save. Strike the knuckle near the tie rod end to dislodge the tie rod end taper (Fig 4). Remove the tie rod ends from the knuckles.

**FIGURE 4**



12. Disconnect the ABS brake wire from the connector at the top of the frame (Fig 5) Remove the wire from the plastic retainers on the frame and upper control arm (Fig 6).
13. Disconnect the rubber brake line brackets from the upper control arm and the steering knuckle (Fig 6). Save hardware.

**FIGURE 5**



**FIGURE 6**



14. Remove the two bolts mounting the brake caliper assembly to the steering knuckle and hang the caliper out of the way (Fig 7). Do not hang the caliper by the brake hose. Save mounting bolts.

**FIGURE 7**



15. If equipped, remove the rotor retaining clips from the wheels studs. These will not be reused. Remove the brake rotor and set aside.
16. Remove the upper ball joint nut. Thread the nut back on by hand one or two turns. Strike the knuckle near the upper ball joint to release the taper. Remove the upper ball joint nut (save) and remove the ball joint from the knuckle.
17. Remove the lower ball joint nut and thread back on by hand one or two turns. Strike the knuckle near the ball joint to release the taper. Remove the ball joint nut and remove the knuckle from the lower control arm. Save the lower ball joint nut and set the knuckle/hub assembly aside.
18. Disconnect the shocks from the frame and lower control arm. Remove shocks. The shocks and hardware will not be reused.
19. Remove the front and rear lower control arm bolts and remove the control arms from the vehicle. Save the control arms and mounting hardware.
20. Remove the factory bump stops from the frame (Fig 8). Save bump stops and hardware.

**FIGURE 8**



21. Remove the four bolts mounting the rear crossmember to the rear lower control arm pockets (Fig 9). Remove the crossmember from the vehicle. The crossmember and hardware will not be reused, 4WD model shown, 2WD similar.

**FIGURE 9**

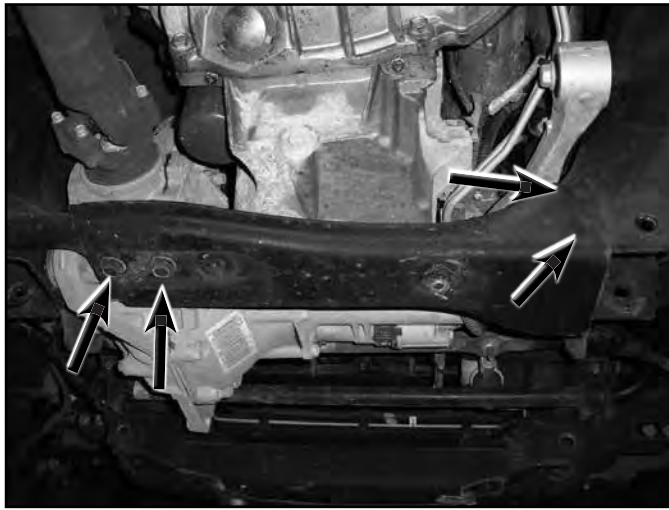

22. Inspect the inside factory control arm mounting holes. There will be a sharp lip left from the original control arm/hardware. Use a file or rotary grinder to remove the sharp lip left from the control arms (Fig 10). This will allow the new cross members to be installed easily.

**FIGURE 10**



23. Locate the new front crossmember (02190). Install the crossmember in the front lower control arm pockets so that the two longer differential mounting tabs are on the driver's side pointing rearward (Fig 11). Fasten the crossmember with the original lower control arm hardware. Run the bolts from front to rear. Leave hardware loose.

**FIGURE 11**





24. Install the new provided bump stops (M02096RB) on the new rear crossmember (02191) with 3/8" hex nuts, flat and lock washers (BP 544). Tighten hardware securely (Fig 12).

**FIGURE 12**

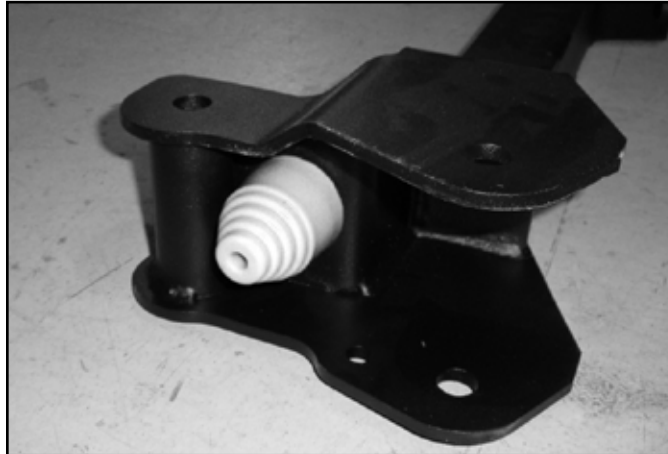

25. Install the rear crossmember in the rear lower control arm pockets, fasten the crossmember with the original lower control arm hardware. Run the bolts from front to rear. Leave hardware loose.
26. Locate the two existing holes in the original bump stop mounts on the frame. Drill the small holes out to 7/16" (Fig 13).

**FIGURE 13**



27. Locate the new provided bump stop brackets (02199). Place a bump stop bracket up to the original mount and line up the center of the two slots with the two holes in the factory mount. Using the third slot in the bracket as a guide, mark the center position to be drilled (Fig 14). Remove the bracket and drill a 7/16" hole at the mark.

**FIGURE 14**



28. With the holes drilled, attach the new brackets to the frame with  $3/8"$  x  $1-1/4"$  bolts, nuts and  $3/8"$  washers (BP 575). The two outer bolts should be all the way to the outer edge of the slots in the brackets (bracket push inward toward frame as far as possible). Torque bolts to 30 ft-lbs. Install the factory bump stop on the new brackets with the original mounting nut. Install the bump stop so it is offset toward the rear of the vehicle (Fig 15). Tighten bump stop hardware securely.

**FIGURE 15**



29. Install the factory lower control arms into the new crossmembers. Fasten the control arms with  $5/8"$  x  $5"$  bolts (front),  $5/8"$  x  $6"$  bolts (rear), nuts and  $5/8"$  SAE washers (BP 544). Run the front bolts front to rear, rear bolts rear to front (Fig 16), install spacer tubes. Leave hardware loose.

**FIGURE 16**



30. Located the factory shock mount bolted to the lower control arm. Remove the shock mount by removing the two mounting bolts. These bolts are held in place with thread locker so take care not to break the bolts with excessive force when removing. Save the bolts and discard the bracket.
31. Install the provided aluminum spacer (02196) into the torsion bar hex hole in the control arm (Fig 17). Install the new torsion bar bracket on the control arm so that the large mounting holes align with the aluminum spacer and the smaller slots align with the original shock mount bolt holes (Fig 18). Loosely fasten the bracket with the provided  $3/4"$  x  $4-1/2"$  bolt, nut and  $3/4"$  SAE washers.



**Tip** Torsion bar relocation bracket hardware is in bolt pack #571.

32. Fasten the torsion bar bracket to the original shock mount holes with the original mounting bolts. Use Loctite on the bolt threads and torque to 30 ft-lbs. With the shock mount hardware tight, torque the  $3/4"$  bolt to 150-165 ft-lbs.

**FIGURE 17**



**FIGURE 18**

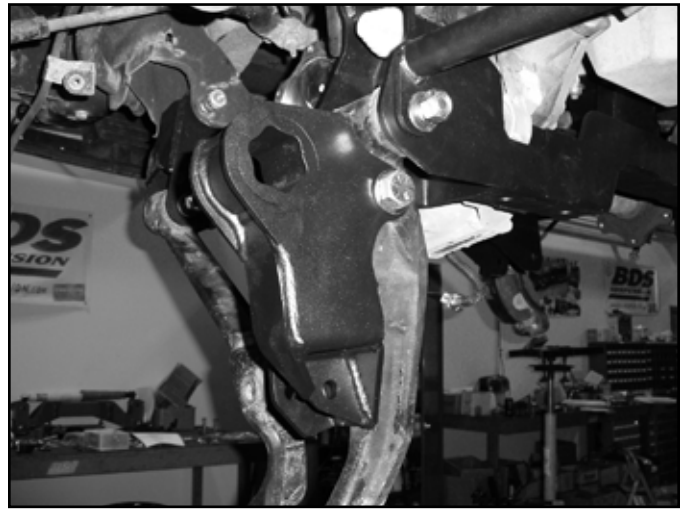

33. Remove the hub bearing and brake dust shield from the factory steering knuckles (Fig 19). Be sure to note which hub goes on which side of the vehicle. Locate the hub o-ring inside the knuckle hub bore. Using a small flat head screw driver remove the o-ring for use in the new knuckle (Fig 20). Save mounting bolts, o-ring, dust shield and hub, discard the knuckle.

**FIGURE 19**



**FIGURE 20**



34. Locate the new steering knuckles and identify the driver's and passenger's side. Install the appropriate knuckle on the lower control arm and fasten with the original lower ball joint nut. Swing the knuckle up and attach to the upper ball joint with the original nut. **Narrow Track Knuckles:** Install the provided "L" shaped brake line bracket (02330) to knuckle with the upper ball joint nut. Position the bracket so the long tab is toward the rear of the vehicle (Fig 25A). Torque the upper ball joint nut to 37 ft-lbs and the lower ball joint nut to 74 ft-lbs.
35. Standard Knuckle Kits Only: Install the factory hub o-ring into the new knuckle hub bore. Install the hub on the appropriate new knuckle so that the ABS line runs out under the steering arm (front - Fig 21). Fasten the hub with the factory bolts. Apply Loctite to the bolt threads and torque to 133 ft-lbs.

 **Tip** The original brake dust shield will not be used.

36. Narrow Track Knuckle Kits Only: Install the factory hub o-ring into the new knuckle hub bore. Install original hub with the original brake dust shield on the appropriate new knuckle so that the ABS line runs out the top of the hub. Fasten the hub to the knuckle with three of the four original bolts and one of the provided 14mm x 100mm bolts/washers (BP 578). Apply Loctite to the bolt threads and torque to 133 ft-lbs. (Fig 22)

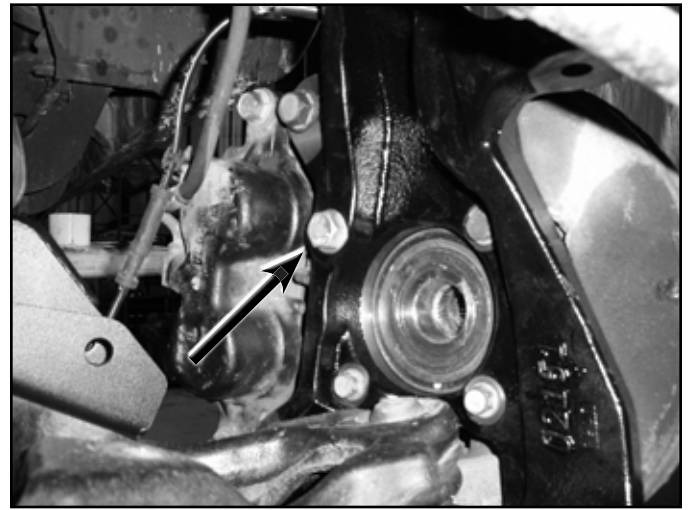

**FIGURE 21****FIGURE 22**

37. Install the brake rotor on the hub. Install the brake calipers on the knuckles with the original bolts. Apply Loctite to the bolt threads and torque the bolts to 125 ft-lbs. Be sure the brake hose is running under the upper control arm and behind the steering knuckle.
38. **Standard Knuckle Kits Only:** Reconnect the brake hose bracket to the upper control arms with the original bolt. Torque to 10 ft-lbs. Attach the second brake hose bracket to the holes in the back side of the steering knuckle with a provided 1/4" x 3/4" bolt and washer (BP 544). Torque to 10 ft-lbs (Fig 24A).
39. **Standard Knuckle Kits Only:** Route the ABS line from around the back side of the knuckle and attach to the two threaded holes with the provided wire clamps and 1/4" x 3/4" bolts and washers (BP 544). From there run the ABS line up along the brake line to the frame and reconnect to the connector and plastic retaining clip. Zip tie the ABS line to the brake line (Fig 24B).

**FIGURE 24A****FIGURE 24B**

40. **Narrow Track Knuckle Kits Only:** Reconnect the original brake hose bracket to the upper control arm with the original bolt. Torque to 10 ft-lbs. Attach the second original brake hose bracket to the new "L" bracket install on the knuckle at the upper ball joint with a provided 1/4" x 3/4" bolt, nut and washers (BP 578). Torque to 10 ft-lbs.
41. **Narrow Track Knuckle Kits Only:** Route the ABS wire to the factory brake line bracket that was just attached to the new "L" bracket. Attach the ABS line to the factory bracket (Fig 25B) with a provided wire clamp and 1/4" x 3/4" bolt, nut and washer (BP 578). Torque hardware to 10 ft-lbs. From there run the ABS line along the main brake line and reattach to the connector at the frame. Zip tie the ABS line to the brake line.

**FIGURE 25A**



**FIGURE 25B**

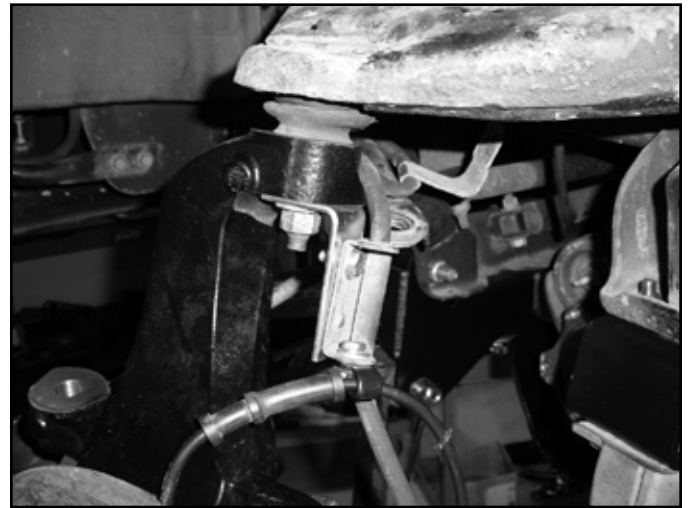

42. Install the provided offset sway bar link u-bracket (02102) on the lower control arm in the original sway bar link hole with a 5/8" x 1-3/4" bolt, nut and washers (BP 569). Position the bracket so that it offsets in toward the center of the vehicle (Fig 26). In some cases it may be necessary to slightly clear to hole for the 5/8" hardware. (4wd model shown - 2wd similar)

**FIGURE 26**



43. Locate the new front sway bar links (911109), small hourglass bushings (SB35BK) and 0.750" OD x 1.575" long sleeves (54587). Install the bushings and sleeves into the eyes of the links. Install the links into the new brackets on the lower control arms with 9/16" x 2-3/4" bolts, nuts and washers (BP 569). Run the bolts from front to rear and leave hardware loose (Fig 27). (4wd model shown - 2wd similar)

**FIGURE 27**



44. Install a provided stem washer (S100776) followed by a stem bushing (SB26BK) on each sway bar link. Install both links into the sway bar and install a second stem bushing followed by a second washer. Fasten the sway bar link upper assemblies with 3/8" nylock nuts (BP 569). Leave nuts loose (Fig 28).

**FIGURE 28**



45. Attach the tie rod ends to the knuckles. Fasten with the original nuts and torque to 37 ft-lbs.
46. Install the new shocks with the new provided bushings/washers/nuts/sleeves. At the new lower bracket install with a provided 9/16" x 3 1/2" bolt, nut and washers and the following: 9500 gas shocks - install provided 1/2" long spacer over the shock sleeve between the shock bushing and back face of the shock mount. 5500 hydraulic shock - install (2) 3/4" washer between the shock bushing and the back face of the mount and (1) 3/4" washer between the shock bushing and the front face. Tighten the upper hardware until the bushings begin to swell. Torque the lower bolt to 75 ft-lbs.
47. Install the torsion bars into the new torsion bar mounts on the lower control arms and slide forward about 4-6" (Fig 29). Be sure they are installed in the proper location and orientation and they are installed on top of the transmission crossmember.



**FIGURE 29**

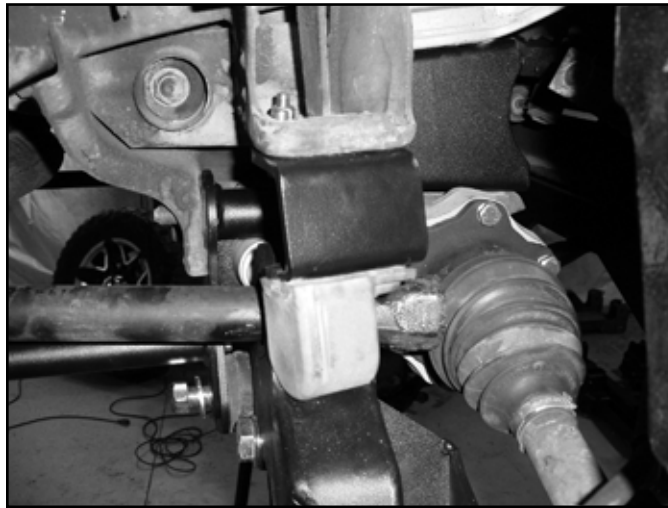

48. If installing optional front skid plate. Attach with factory splash guard hardware at the front frame crossmember. Use new 1/2" button head bolts (#571) to attach skid plate to the crossmember. Tighten to 35 ft-lbs.
49. Reinstall the factory torsion bar crossmember in the original mounts with factory hardware. Torque bolts to 90 ft-lbs.



**Tip** *Be sure the crossmember is oriented correctly.*

50. Locate the original torsion bar adjuster plates. Slide the torsion bars back into the torsion bar crossmember and into the adjuster plates. The plates should fit on the torsion bars so that they positioned roughly horizontal in the vehicle.
51. Load the torsion bars with the appropriate tool. Reinstall the adjuster bolt/retaining plate assembly. Reset the torsion bar adjuster bolt position to the original height measurement taken at the beginning of the installation. This adjustment will be checked/changed at the end of the installation.
52. Install the front wheels. Torque the lug nuts to 140 ft-lbs. Lower the vehicle to the ground.
53. Bounce the front end to settle the suspension.
54. Tighten the upper sway bar link stem nuts until the bushings begin to swell. Torque the lower sway bar link bolt to 90 ft-lbs.
55. Torque the lower control arm bolts (4) to 125 ft-lbs.
56. Check all front hardware for proper torque.
57. Check all brake lines for proper clearances. Adjust as necessary.
58. Check tire/wheel clearance with the fenders/bumper as well as with the steering knuckle. It is not uncommon to trim the lower plastic valance of the bumper slightly to add proper tire clearance while turning.

## **REAR INSTALLATION**

1. Block the front wheels for safety. Raise the rear of the vehicle and support with jack stands under the frame rails, just ahead of the front leaf spring hangers.
2. Remove the wheels.
3. Disconnect the parking brake cable brackets (2) from the driver's side frame rail (Fig 30) Save all hardware.

**FIGURE 30**



4. Disconnect the factory brake line bracket attached driver's side frame rail. The nut is accessed on the outside of the frame (Fig 31).

**FIGURE 31**



5. Support the center of the axle with a hydraulic jack. Remove the factory shocks from the axle and frame. Save hardware and discard shocks.

### **LIFT BLOCK INSTALLATION**

6. With the axle still well support remove the passenger's side u-bolts. The u-bolts will not be reused. Slowly lower the axle and remove the factory block from the axle. The factory block will not be reused.
7. Lower the axle just enough to install the new provided 5" lift block between the axle and the spring. Align the pin in the block with the hole in the axle and the hole in the block with the leaf spring pin. It may be necessary to loosen the driver's side u-bolts slightly to allow the axle to lower far enough to install the block.
8. Using the support jack, raise the axle so that the axle, spring and block are all touching. Install the new provided u-bolts, nuts and washers allow with the factory u-bolt plate (Fig 32). Snug u-bolts but do not tighten.

**FIGURE 32**



9. Repeat the installation on the driver's side of the vehicle. Pay special attention to all of the brake lines and wires. Do not allow them to get over-extended.

### **SPRING INSTALLATION**

10. Lower the axle from the spring. Remove the front spring hanger bolt and rear spring shackle-to-frame bolt. Remove the spring from the vehicle.
11. Lightly grease and install the provided bushings and sleeves in the new BDS leaf springs.
12. Remove the shackle from the factory springs and loosely install it on the corresponding end of the BDS spring.
13. Install the new spring in the vehicle with the factory hardware. Leave hardware loose.
14. Using the support jack, raise the axle so that the axle and spring are touching and align the spring center pin in the hole in the axle. Install the new provided u-bolts, nuts and washers allow with the factory u-bolt plate. Snug u-bolts but do not tighten.
15. Repeat the installation on the driver's side of the vehicle. Pay special attention to all of the brake lines and wires. Do not allow them to get over-extended.

### **SPRING AND BLOCK INSTALLATION**

16. Locate the brake line clamp bolt on the driver's side axle shock mount. This bolt must be trimmed flush with the inside surface of the bracket to avoid contact with the new shock (Fig 49). Trim the bolt with a reciprocating saw or cut-off wheel.
17. Locate the new shocks/bushings/sleeves. Install the provided hourglass bushings and sleeves in the new shocks. Install the shocks in the vehicle with the original hardware. The body of the shock must be mounted to the axle. In some cases the axle shock brackets will need to be bent open slightly to provide clearance for the new, wider shocks. This can be easily done by putting an adjustable wrench on side of bracket that needs to be formed and bending out just enough to clear the shock body. Torque shock bolts to 70 ft-lbs.
18. Reattach the parking brake cable brackets to the driver's side frame rail. It may be necessary to remove the driver's side cable from the rear most bracket to allow for enough slack. Torque bracket bolts to 20 ft-lbs.
19. Locate and remove the factory bump stops from the driver's and passenger's frame rails (Fig 33). Save hardware.



**FIGURE 33**



20. Install the factory bump stops on the new provided bump stop spacer (01196B) with the factory hardware. The bump stop will mount to the spacer on the face with 3 holes. Tighten hardware securely. (Fig 34)

**FIGURE 34**



21. Install the extended bump stops to the original holes on the frame with the 3/8" hardware in bolt pack 422. Install the bump stops so the open face of the extension is toward the inside of the vehicle (Fig 35). Torque bolts to 25 ft-lbs.
22. On the driver's side, attach the factory brake line bracket to the hole in the new bump stop extension with the original hardware (Fig 36). Torque nut to 25 ft-lbs.

**FIGURE 35**



**FIGURE 36**

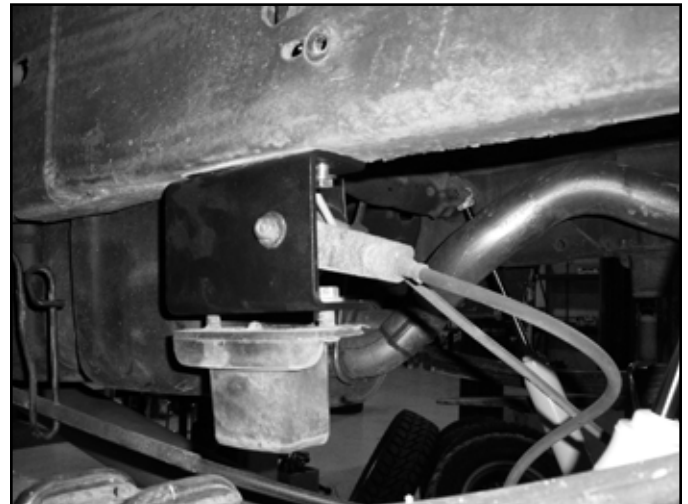

23. Install the wheels. Torque lug nuts to 140 ft-lbs. Lower the vehicle to the ground.
24. Bounce the rear of the vehicle to settle the suspension.
25. Torque the u-bolts to 90-100 ft-lbs.
26. Check all rear hardware for proper torque.

## **POST-INSTALLATION**

1. Check all hardware for proper torque.
2. Reconnect the positive and negative battery cables.

## **SET FRONT SUSPENSION HEIGHT**

3. It is very common for the particular vehicle model to have widely varying starting suspension heights. In order to give a more precise suspension height setting we have provided a Z-height reference. Refer to Figure 37.
4. Roll the vehicle forward and back to settle the front suspension. With the vehicle on flat, level ground measure the distance from the floor to the center of the front lower control arm bolt. This is distance 'Y'. Record here: \_\_\_\_\_
5. Measure from the floor up to the top, inner lip of the lower ball joint mount on the new steering knuckle (Fig 38). This is distance 'X'. Record here: \_\_\_\_\_

**FIGURE 37**

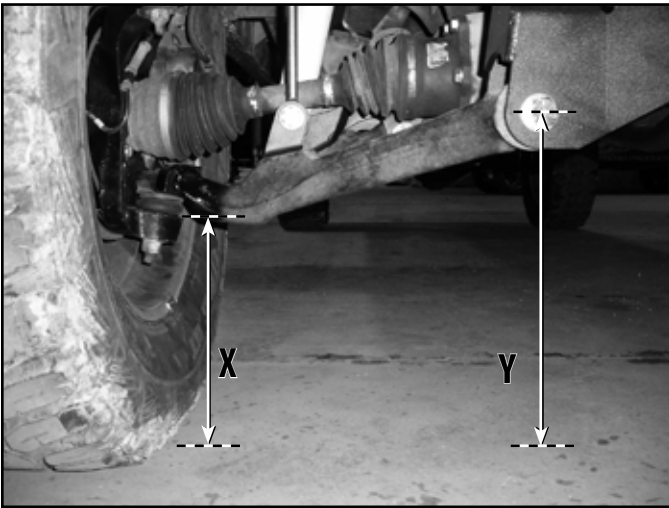

**FIGURE 38**

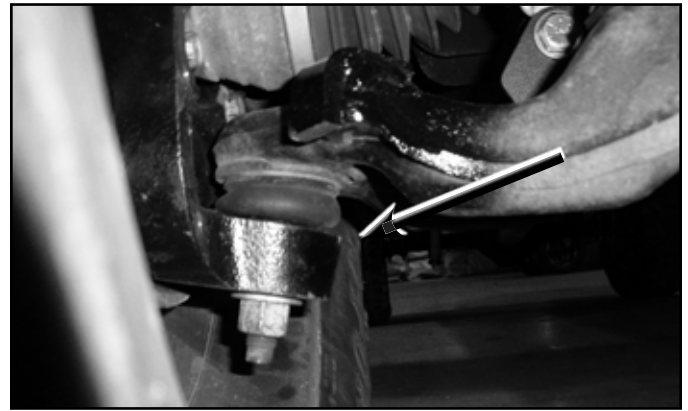

6. To determine the Z-height use the following equation:  $Y-X=Z$ . For the intended 7" of lift the value for Z should be approximately 4". If your value for 'Z' is less than 4" the torsion bars need to be adjusted up (tightened). If your value for 'Z' is more than 4" the torsion bars need to be adjusted down (loosened). These values are for reference but should not vary more than 1" in either direction.

## **FINAL CHECK**

7. The vehicle will need a complete front end alignment.
8. Check all hardware after 500 miles.
9. Adjust headlights.