

# 2003-05 Dodge 5.9L Cummins Remote Mount BD Exhaust Brake Installation Instructions

<b>1027338</b>	<b>2003-2005</b>	<b>Remote Mount 4" Exhaust</b>
----------------	------------------	--------------------------------

**\*\*\* Please read this manual before starting installation. \*\*\***

**OWNER'S MANUAL - LEAVE IN GLOVE BOX**

**The brake pressure at idle must be checked and adjusted at time of install, at least two weeks after install, and at regular twice a year intervals.**

# Table of Contents

<b>Kit Contents</b> .....	<b>3</b>
<b>Introduction</b> .....	<b>4</b>
<b>Optional Accessories</b> .....	<b>4</b>
<b>Notes on Connectors</b> .....	<b>4</b>
<b>Tools Required</b> .....	<b>5</b>
<b>Installation</b> .....	<b>5</b>
Brake Valve Installation .....	5
Air Hose Installation .....	8
Air Compressor Mounting Installation .....	9
Regulator Installation .....	11
Regulator Plumbing and Electrical .....	12
DFIV Installation .....	14
Accelerator Pedal Position Sensor Wiring (2003-04).....	14
Accelerator Pedal Position Sensor Wiring (2005).....	16
Cruise Control Wiring Installation .....	17
Switch Install (Required if using main toggle switch) .....	18
<b>Optional Manual Shifter Switch (Push-Pull Style)</b> .....	<b>21</b>
<b>Optional Manual Shifter Switch (Rocker Switch Style)</b> .....	<b>22</b>
<b>Wiring &amp; Plumbing Diagram</b> .....	<b>23</b>
DFIV Adjustment & Testing.....	24
DFIV Operation .....	24
<b>Exhaust Back Pressure Testing for Air Actuated Brakes</b> .....	<b>25</b>
Idle Pressure Test.....	25
Off-Idle Pressure Test & Adjustment .....	26
<b>Maintenance</b> .....	<b>27</b>
<b>Operating Guidelines</b> .....	Error! Bookmark not defined.
<b>Air Brake Troubleshooting Guide</b> .....	<b>28</b>

## Kit Contents

Please check to make sure that you have received all parts for your kit

<p><b>1127038-A</b></p>	<p><b>1030129-D</b></p>	<p><b>1220113-A</b></p>
		
<p><i>Valve Assembly</i></p>	<p><i>Compressor Assembly</i></p>	<p><i>Air Tubing Assembly</i></p>
<p><b>Qty: 1</b></p>	<p><b>Qty: 1</b></p>	<p><b>Qty: 1</b></p>
<p><b>1100400</b></p>	<p><b>1100404</b></p>	<p><b>1100740</b></p>
		
<p><i>4" Pipe Adapter</i></p>	<p><i>4" Marmon Clamp</i></p>	<p><i>4" S/S Exhaust Clamp</i></p>
<p><b>Qty: 2</b></p>	<p><b>Qty: 2</b></p>	<p><b>Qty: 1</b></p>
<p><b>1300131</b></p>	<p><b>1321039</b></p>	<p><b>1220139-A</b></p>
		
<p><i>6" Tie Wraps</i></p>	<p><i>DFIV Controller and Wiring Kit</i></p>	<p><i>Regulator/Control Assy.</i></p>
<p><b>Qty: 12</b></p>	<p><b>Qty: 1</b></p>	<p><b>Qty: 1</b></p>

## Introduction

Thank you for purchasing a BD Exhaust Brake.

This exhaust brake kit installs inline in the exhaust pipe downstream from the turbocharger. It is intended for applications where the stock turbocharger has been removed or changed, and the turbo mount version of the BD Exhaust Brake cannot be installed. This kit requires the vehicle have a 4" exhaust pipe for installation.

This manual is divided into different areas to assist you with the installation and operation of your braking unit. We strongly suggest that you write down the kit and serial numbers of your unit in the spaces provided and retain this manual for any future reference.

## Optional Accessories

Description	Part #
Manual Transmission Shifter Switch Kit	<b>1300210 or 1030900</b>
AutoLoc Converter Lock-up Kit	<b>1030390</b>
Torqloc Converter Lock-up Kit	<b>1030395</b>
Performance BD Valve Body	<b>CALL</b>
Brake pressure gauge kit	<b>1030050</b>

## Notes on Connectors

The kit includes a number of Posi-Tap™ connectors (Gray or Red/Black/Green or Yellow) to tap onto OEM wiring. It is important to select the correct color of connector so that it matches the gauge of the OEM wire that it is being installed on. Using the incorrect connector could cause an inadequate connection and/or the OEM wire could be severed.

OEM Wire	Posi-Tap™ Color
18-22ga	Gray or Red
12-18ga	Black
10-12ga	Green or Yellow

Though these connectors offer a quicker installation, the best option would be to solder the wires and isolate the joints with heat shrink or liquid electrical tape. Proper soldering techniques should be used to ensure adequate connections.

### Posi-Tap™ Connector Usage Diagram

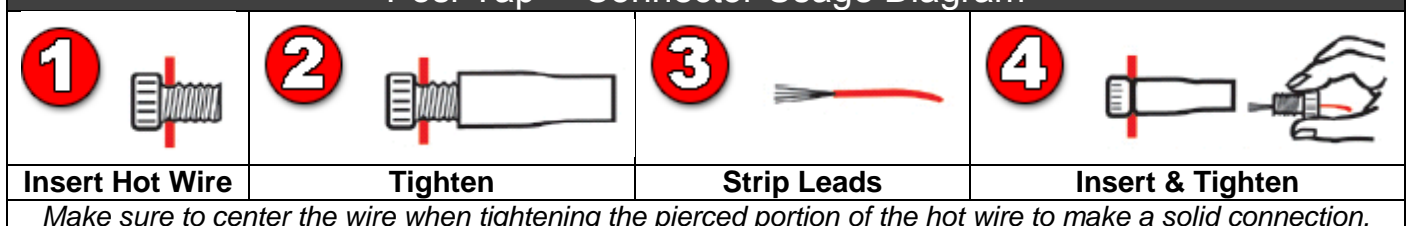

The ground terminals of the vehicle's batteries should be disconnected before performing any piercing/posi-tapping onto any ECM/PCM wire.

## Tools Required

- Measuring tape or ruler
- Reciprocating saw or hacksaw
- Wire Crimping Pliers
- Drill with 1/8", 3/16" bits and Uni-bit
- Small bladed flat tip screwdriver
- Socket Set
- Welder
- Heat gun or lighter
- Test light

## Installation

To prevent damage to electronic components, it is recommended that both battery negative terminals be disconnected while working on the vehicle.

**Please read this manual thoroughly before installing this exhaust brake.**



Raise and support the vehicle with a vehicle hoist or with appropriate jack stands.

Ensure vehicle is safely supported before proceeding to reduce possibility of damage or injury.

## Brake Valve Installation

From underneath the vehicle, remove 2 of the exhaust pipe hanger pins from in front of the muffler, allowing the rear section of the exhaust to hang down and provide access to the exhaust.

**Hint** Spray WD40 on pins and slide the rubber hangers off.

Remove the exhaust clamp that holds the intermediate pipe to the down pipe at the first cross member.

Measure and mark the intermediate exhaust pipe approximately 7 1/4" from the end of the pipe and cut it off.

Separate the cut intermediate pipe from the front pipe by splitting or cutting the side of the intermediate pipe, which will make it easier to remove from the downpipe.

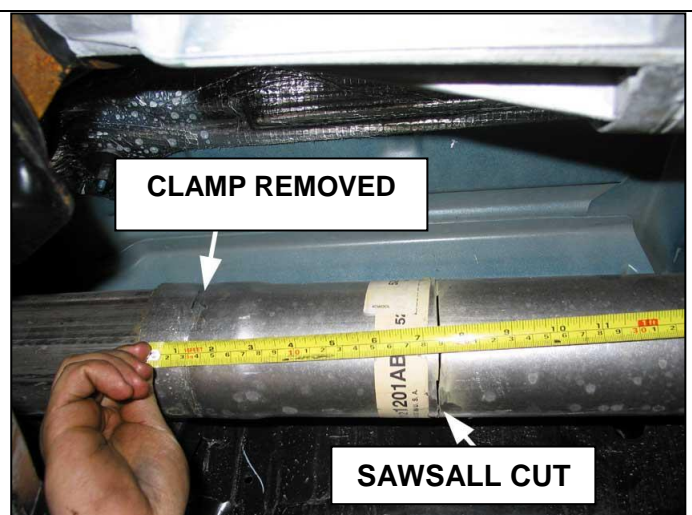
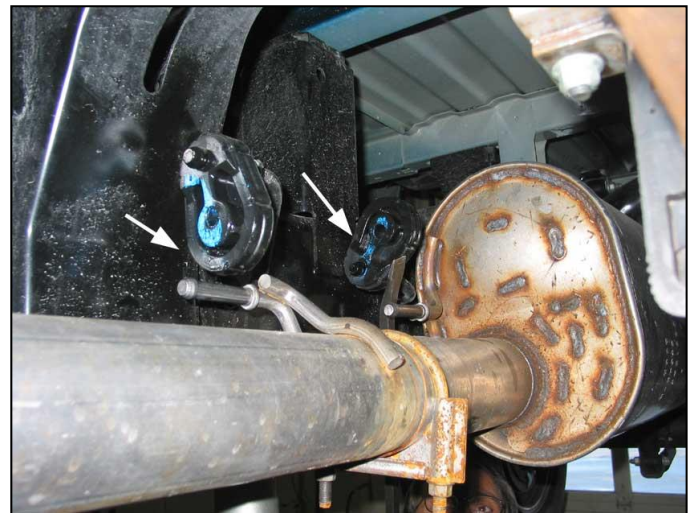

2004.5-2005 Model year trucks have a catalytic converter in the exhaust pipe. Although this pipe has a few additional bends, try to locate the straightest section possible for brake valve installation. To obtain a proper seal with the stainless steel band strap, a straight section of pipe is important.

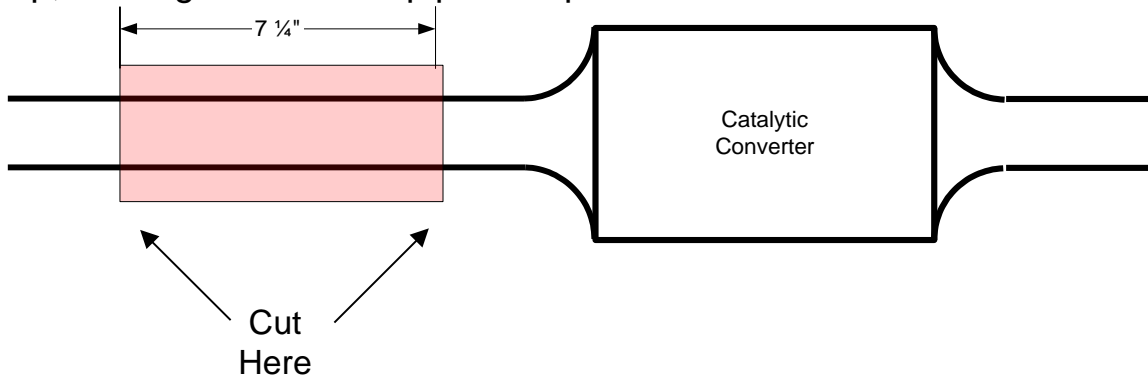

**Caution** Do not cut too deeply when creating a slit in the pipe or you may damage the front exhaust pipe underneath.

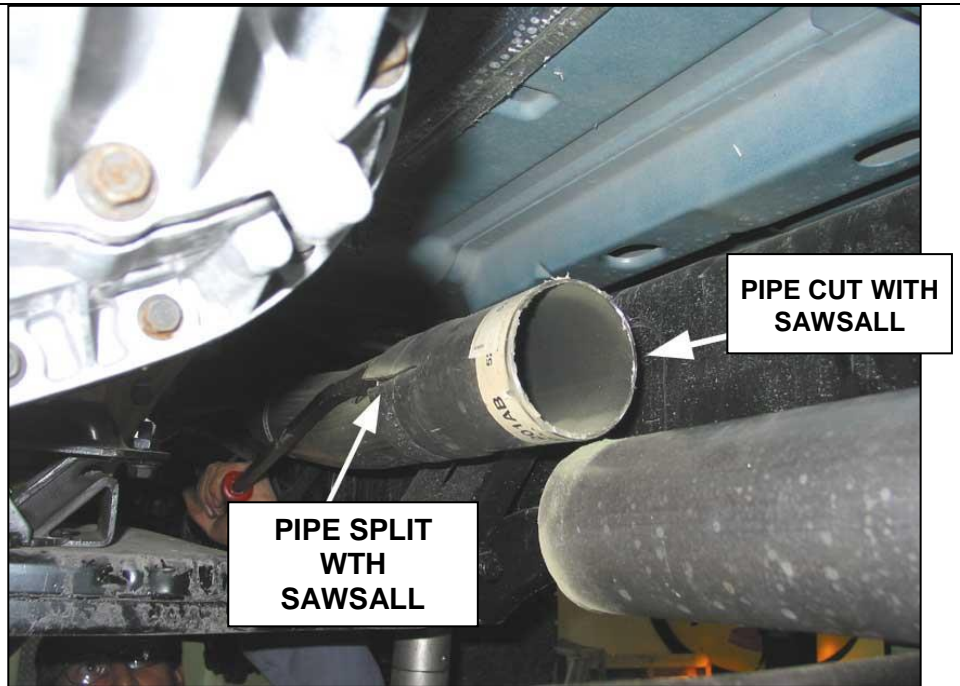

Clean off the cut ends of the intermediate pipe with a file to remove burrs left from cutting and then insert the adapter pipes onto each end of the now exposed pipes.

Re-install the rubber exhaust hangers that were removed earlier.

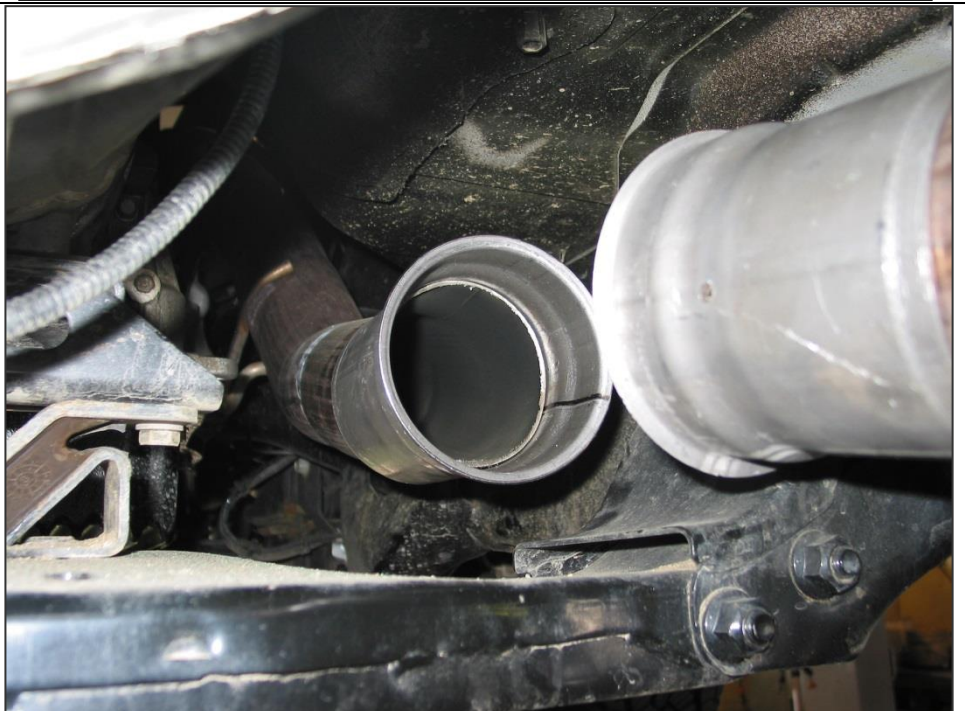

Install the brake valve between the two exhaust pipe adapters using the two supplied V-band clamps. Ensure the exhaust pipe adapters are in line with the brake valve to prevent possible leakage. The air cylinder bracket should face the rear of the vehicle and the exhaust directional arrow on the brake valve should point rearwards.

Ensure the brake air cylinder will not contact anything when the brake valve cycles.

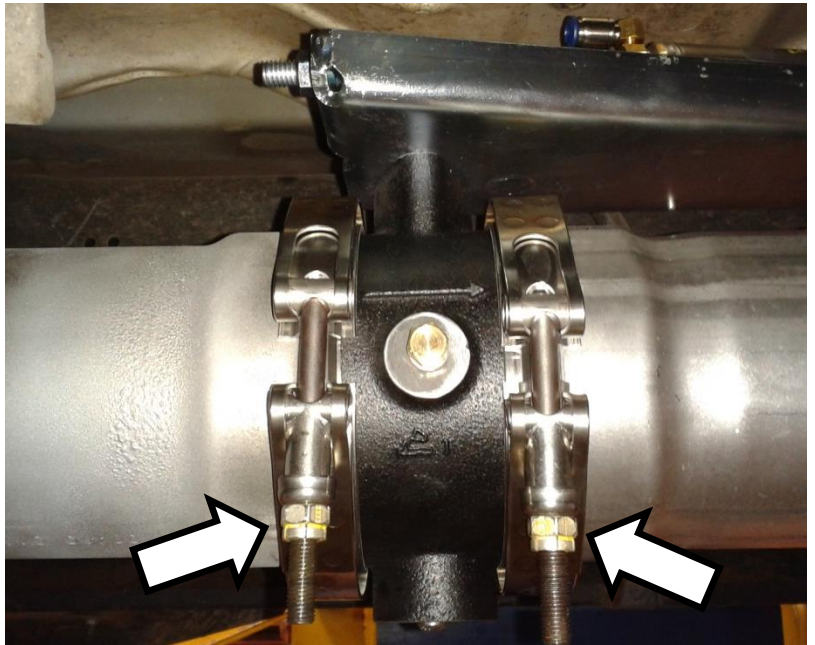

Weld the front adapter to the exhaust pipe. This weld must completely seal the exhaust system as it must retain pressure.

**Note** It is recommended that the weld be spray painted to slow down corrosion along the weld bead.

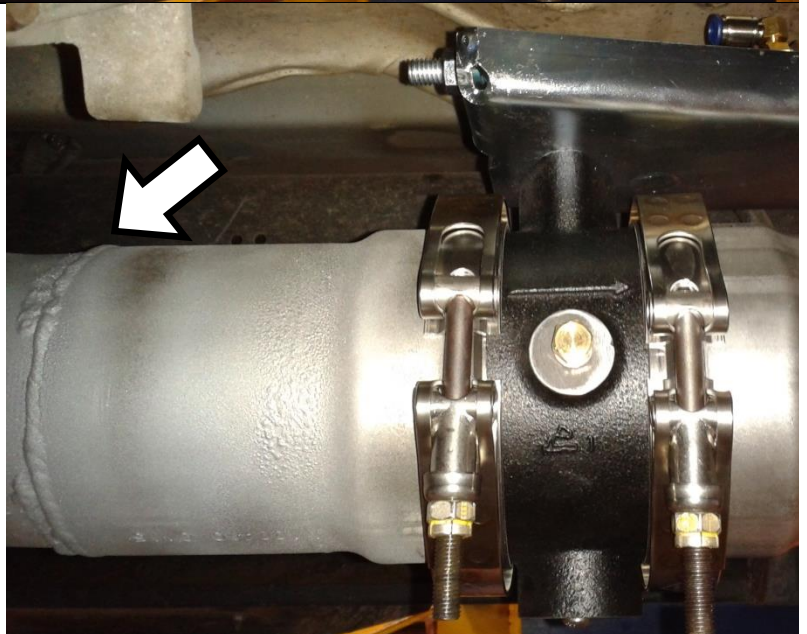

**IMPORTANT** The front exhaust connection **MUST** be welded. Using a band clamp or conventional exhaust clamp on this joint will cause leaks and will not retain full exhaust brake pressures.

Install the supplied stainless steel band clamp on the rear exhaust pipe adapter. Tighten bolts until the band fully conforms to both pipes creating a seal.

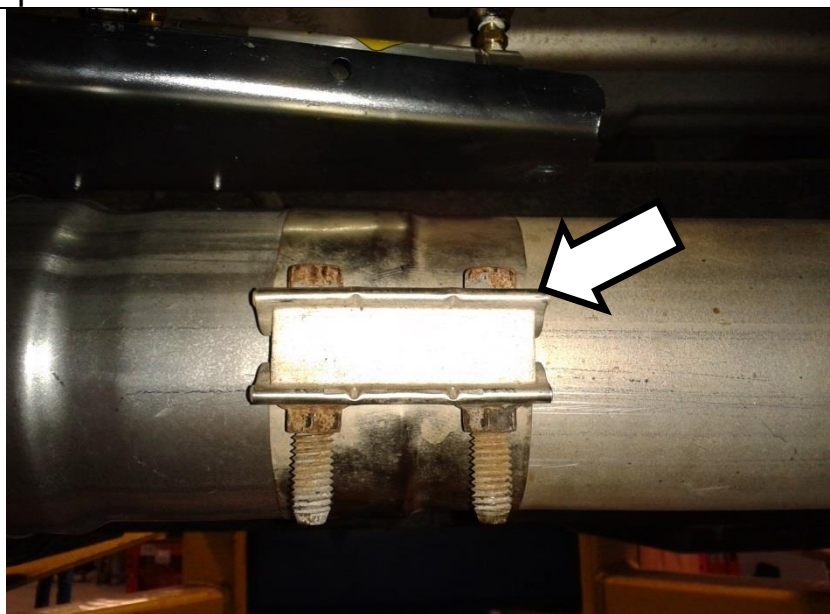

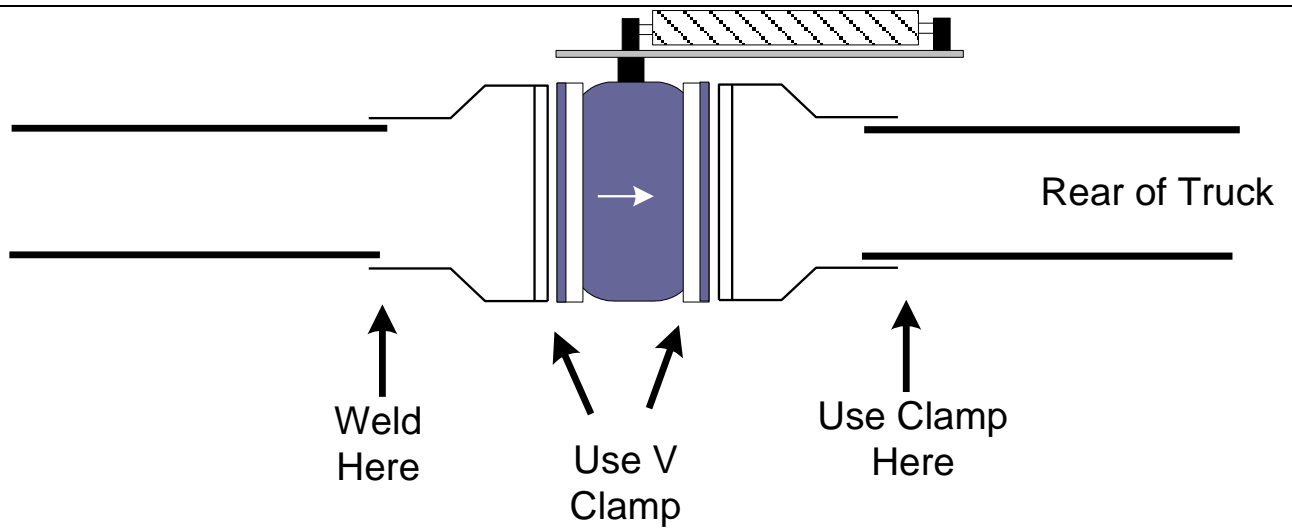

## Air Hose Installation

This kit is supplied with a premade air tubing assembly. The 1/8" air tube is the pressurized air feed to the brake pneumatic cylinder and the 1/4" air tube is the vent line for the cylinder.



Insert the 1/8" air tube into the quick connect fitting on the quick release valve on the air cylinder.

Insert the 1/4" tube into the vent-side quick connect fitting.

Feed the air tubing assembly over the top of the frame rail and support it so that there is no stress on the air tubes where they enter the brake valve.

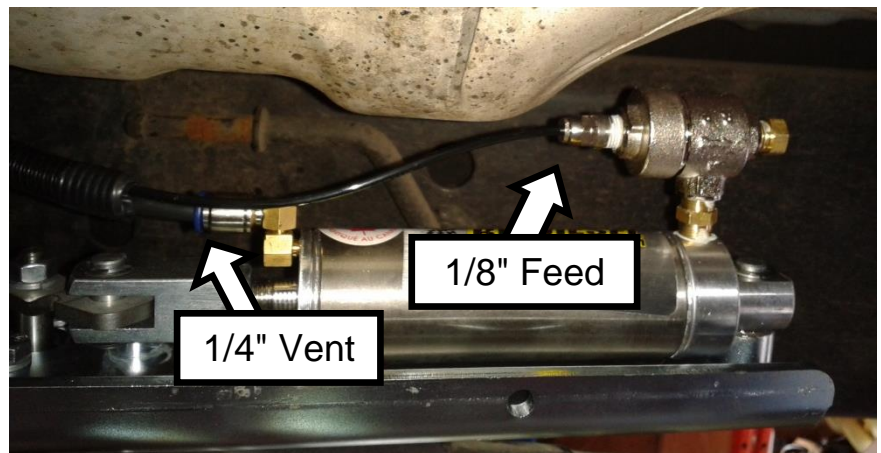

Route the air tubing assembly along the frame rail and secure with wire ties to the existing wiring harness.

Route the other end of the assembly into the engine bay up the passenger side of the firewall. It will be connected later.

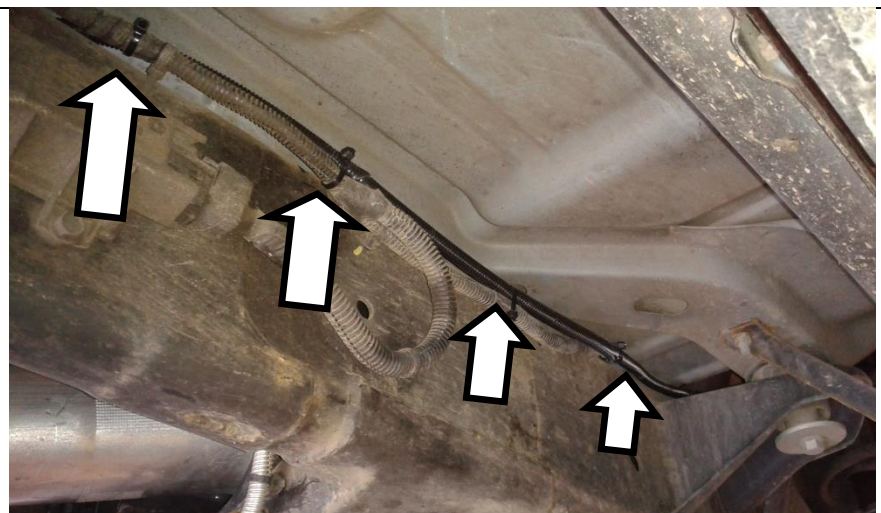



## Air Compressor Mounting Installation

Remove the passenger side front wheel and remove the plastic fender liner from the vehicle to gain access to the inner fender area.

Install the supplied vibration dampening foam tape to the bottom back side of the compressor bracket assembly.



Locate the two mounting points for the compressor.

The compressor bracket is designed to line up with the front hood hinge bolt and an existing hole in the inner fender.

Remove the hood hinge bolt now to allow for installation of the compressor bracket.

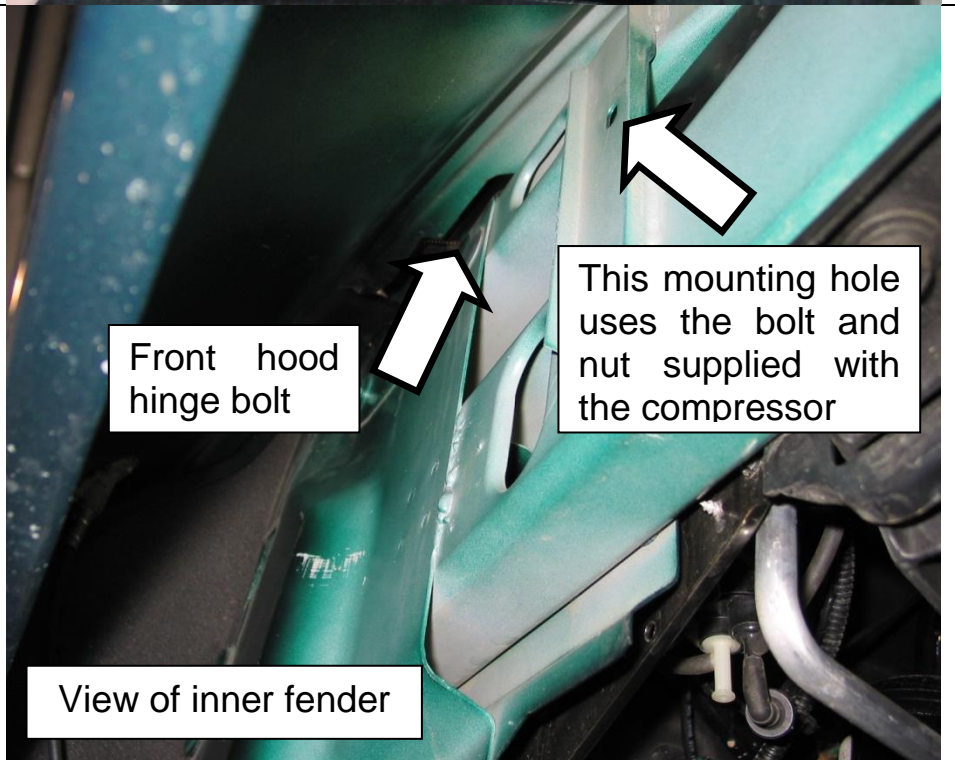

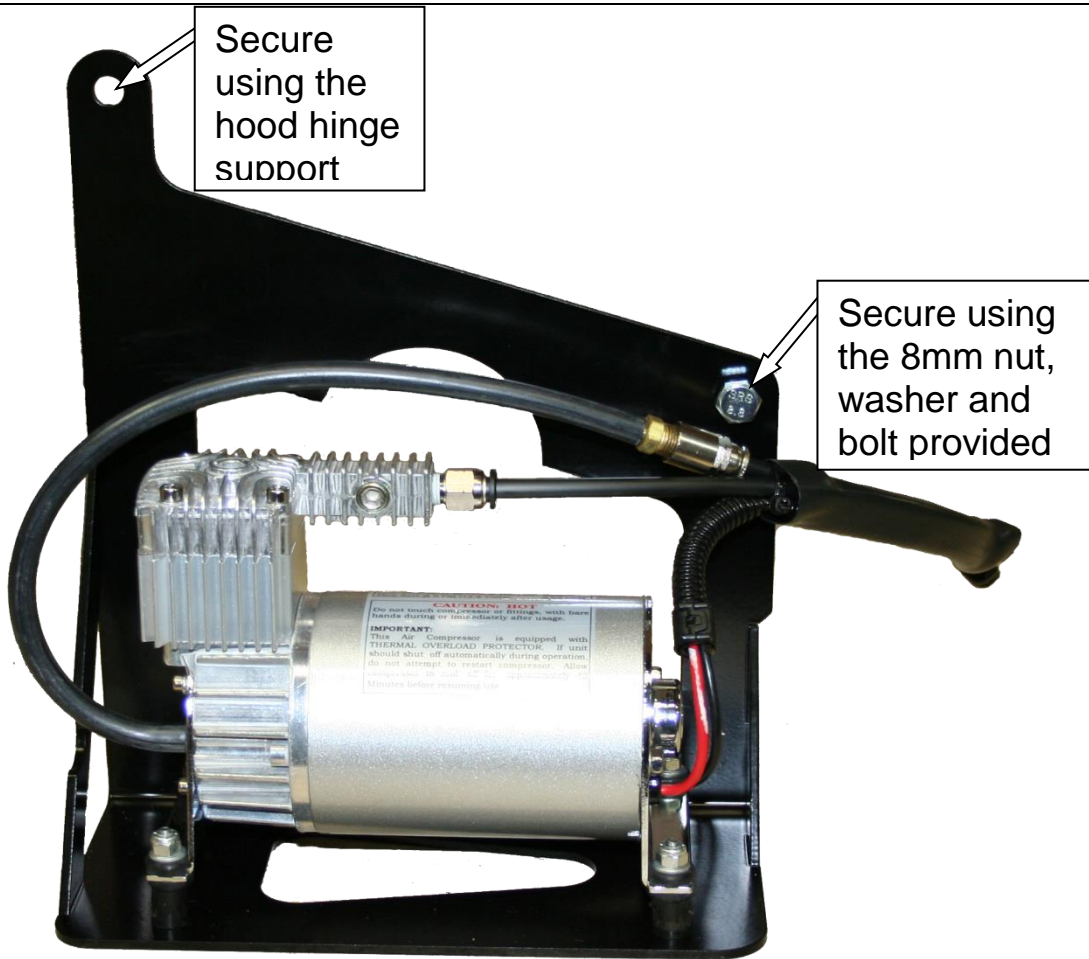

Feed the compressor air lines and wire through the fender into the engine bay, they will be connected later. Lift the compressor into place.



Secure the compressor in place by reinstalling the hood hinge bolt through the compressor bracket. Then install the nut and bolt to hold the front of the bracket.

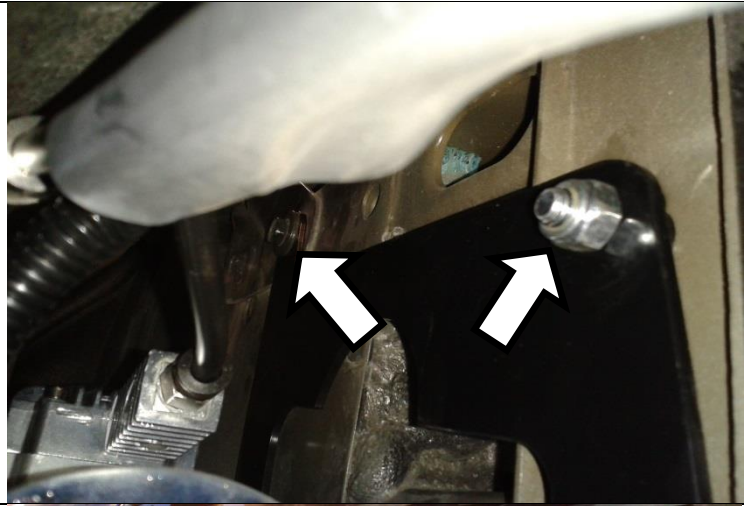

While the fender liner is off, double check that the air tubing assembly installed in the earlier section is well clear of the exhaust pipe, turbocharger and moving suspension components.

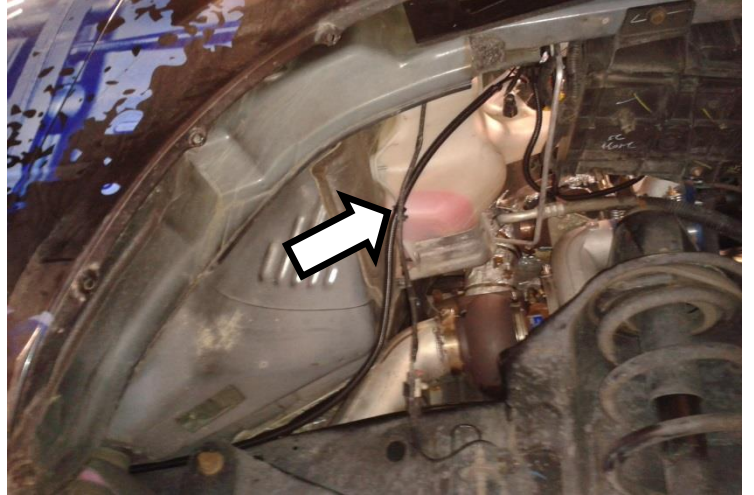

## Regulator Installation

The air pressure regulator assembly is to be mounted at the top of the firewall on the passenger side of the engine bay. The included washer should go directly under the head of the screw to sandwich the sheet metal against the regulator bracket.

Locate the large oval hole on the passenger side of the vehicle near the upper cowl of the firewall. To the right of this you can either drill a 3/8" hole or use the existing hole by removing the factory plastic locking insert.

Install the regulator assembly underneath the hole (shown on figure to the right). The lock washer and flat washer should be installed on top of the plastic cowl with the Phillips screw holding everything in place.

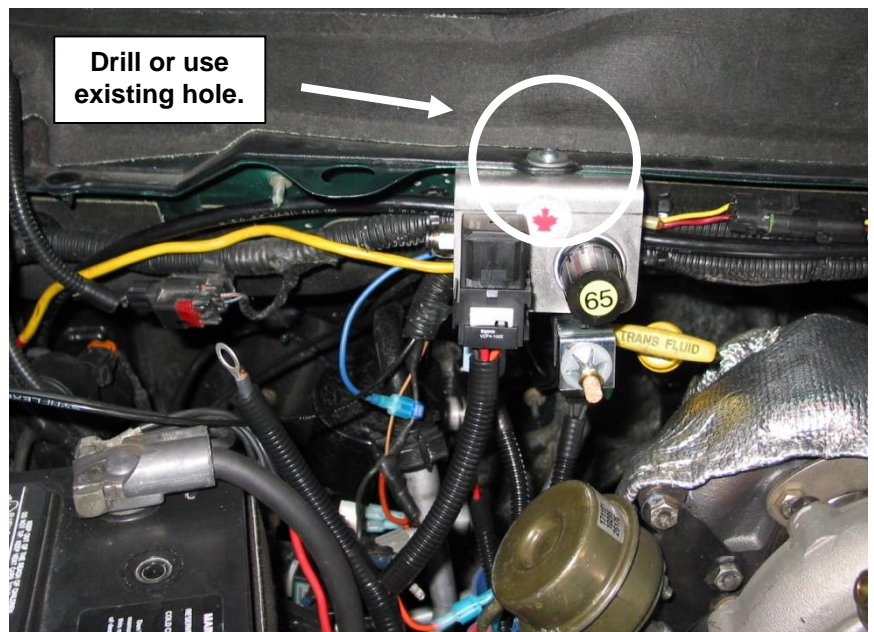

## Regulator Plumbing and Electrical

Connect the air pressure line from the pump to the inlet of the regulator assembly.

This is the shorter of the two 1/4" tubes from the compressor that does not have a fitting on the end. This connects to the passenger side of the regulator assembly, behind the relay.

Trim this tube to length and insert it into the fitting.



The other line from the compressor is the air suction line. This line is 1/4" diameter and comes with a preinstalled threaded adapter. Install the threaded filter supplied with the air pump into this fitting.



Route both the 1/4" suction line from the air pump and the 1/4" vent line from the air cylinder tube assembly to the driver side of the engine bay.

Secure with zip ties to keep the lines up off the motor.

Trim tubes to length if required.

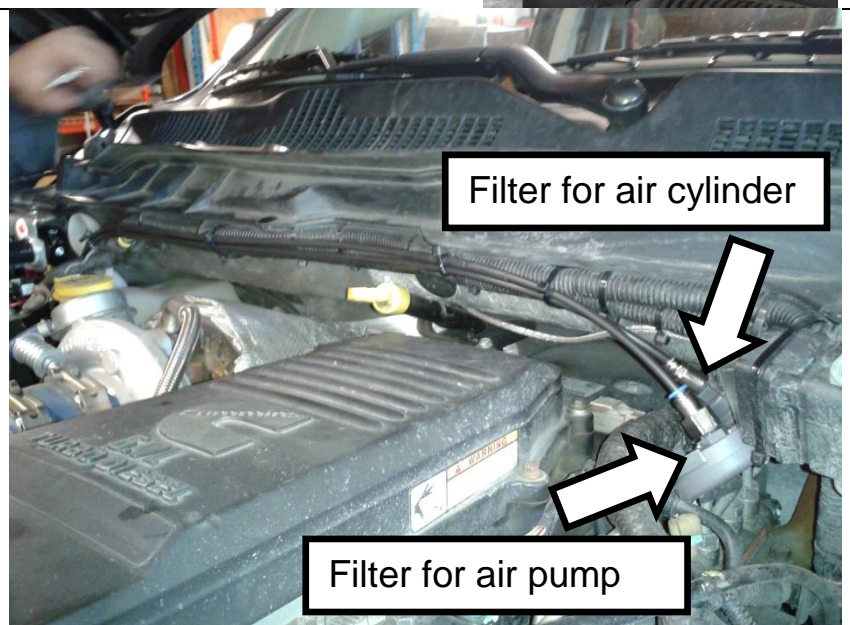

The preferred method of mounting the compressor air filter is just below the hood using a factory mounting location.

The sound deadening material is retained with plastic push in retainers. Remove this retainer and reinstall the air filter using its integral push in clip.



Locate the 1/8" tube from in the air tubing assembly that leads to the brake valve. This will be installed in the output from the air regulator assembly on the bottom of the solenoid.

Trim this tube to length and install it in the 1/8" fitting.

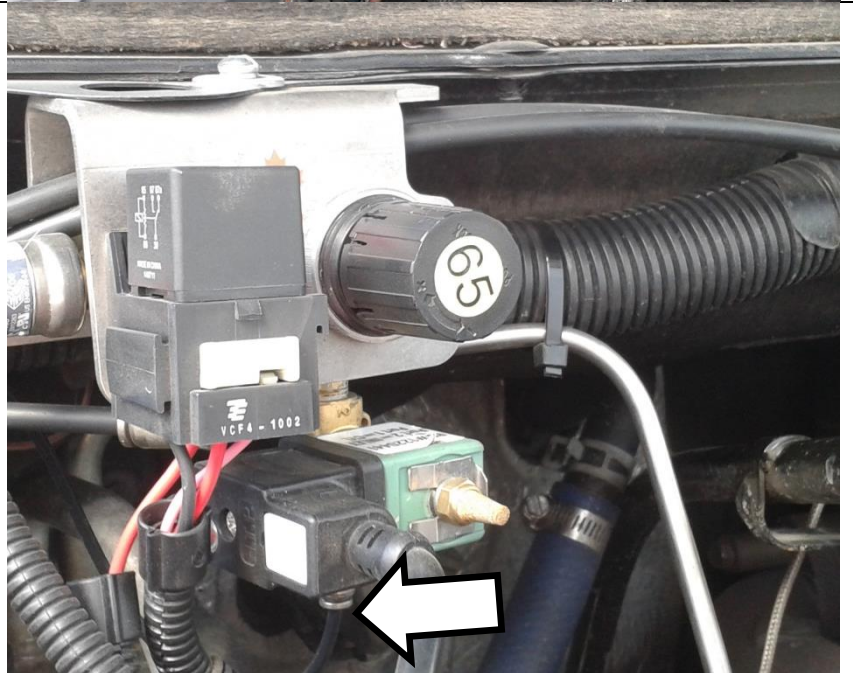

Connect the main ground connection to the body ground on the passenger side of the engine bay near the regulator assembly.

This is the black wire with a ring terminal installed on the end.

Alternatively this may be connected directly to the battery negative terminal if desired.

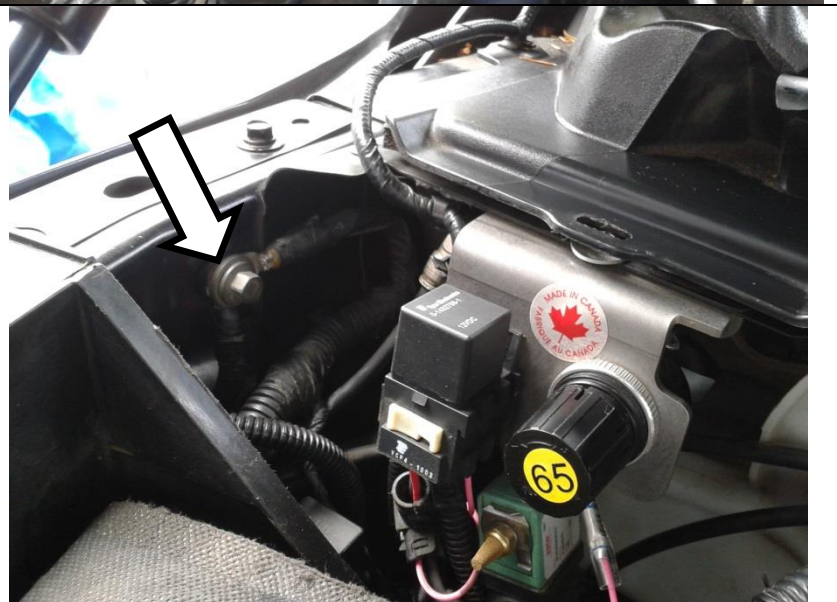

Connect the main power feed to the passenger side positive battery terminal clamp.

This is the red wire with a ring terminal installed on the end.

Connect the two pin gray connector from the regulator assembly to the air compressor. Refer to the next section for the wiring of the DFIV control module. Refer to the wiring and plumbing diagram for more details.

## DFIV Installation

Mount the DFIV module in a secure location under the dash using the cable ties provided and route the pink and yellow wires through the firewall into the engine bay. Attach the black ground wire to the "Gnd" terminal on the DFIV and attach the ring terminal to a good ground.

Crimp the pink DFIV wire, the pink wire from the regulator & relay assembly, and the blue wire from the solenoid valve together, using the crimp connector with the clear plastic heat shrink. Once this is done you can shrink the heat shrink to seal the connection.



## Accelerator Pedal Position Sensor Wiring (2003-04)

There are two possible locations to tap into the accelerator pedal sensor wiring, at the sensor itself or at the ECM. A posi-tap has been included with the DFIV installation kit and may be used to connect to this wire, however soldering this connection is recommended for longevity.

If connecting at the sensor, route the yellow wire in the DFIV kit from the DFIV module to the accelerator pedal sensor mounted either on the side of the engine under a protective cover or beneath the driver's side battery tray depending on model and transmission. See table below for wire colors and location. Once this connection is made, reconnect the APPS electrical connector and reinstall the throttle linkage cover.

If connecting at the ECM, refer to the table below for the appropriate wire color and pin location.

Application	Sensor Location	Sensor Color	Pin/Wire	ECM Pin/Wire Color
2003 Automatic & Early Manual	Engine	APPS Pin 3 – YL		ECM C1 Pin 14 – YL
2003 Late Manual	Battery Tray	APPS Pin 5 – WT/DG		ECM C1 Pin 14 – BR/WT
2004 Automatic	Engine	APPS Pin 3 – BR/WT		ECM C1 Pin 14 – BR/WT
2004 Manual	Battery Tray	APPS Pin 5 – BR/WT		ECM C1 Pin 14 – DB/WT

NOTE: 2003.5-2004 Manual transmission trucks change the wire color between the sensor and ECM.

### 2003-2004 ECM Connector

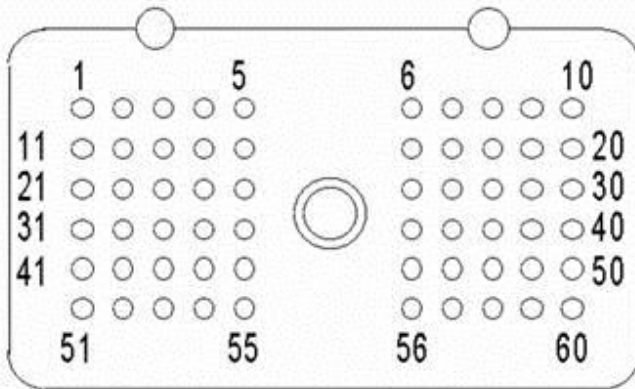

**ENGINE CONTROL  
MODULE C1**

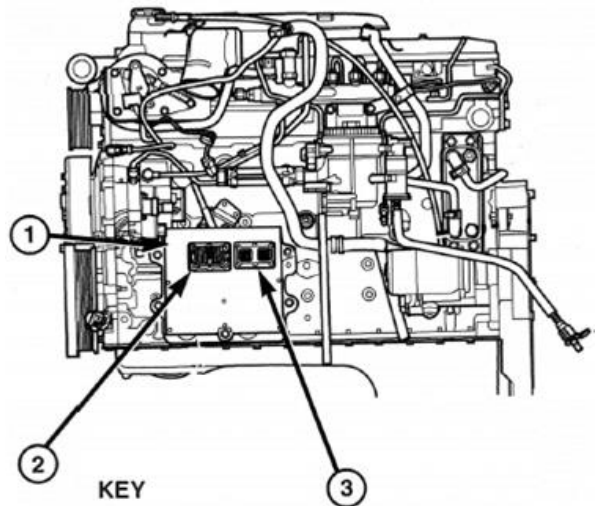

KEY

- 1. Engine Control Module (ECM)
- 2. 60-Way Connector
- 3. 50-Way Connector

### Engine Mounted APPS

**Throttle linkage cover removed**

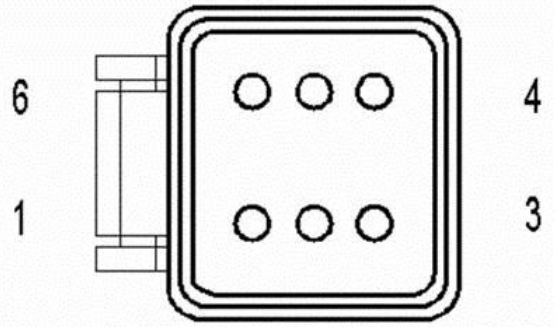
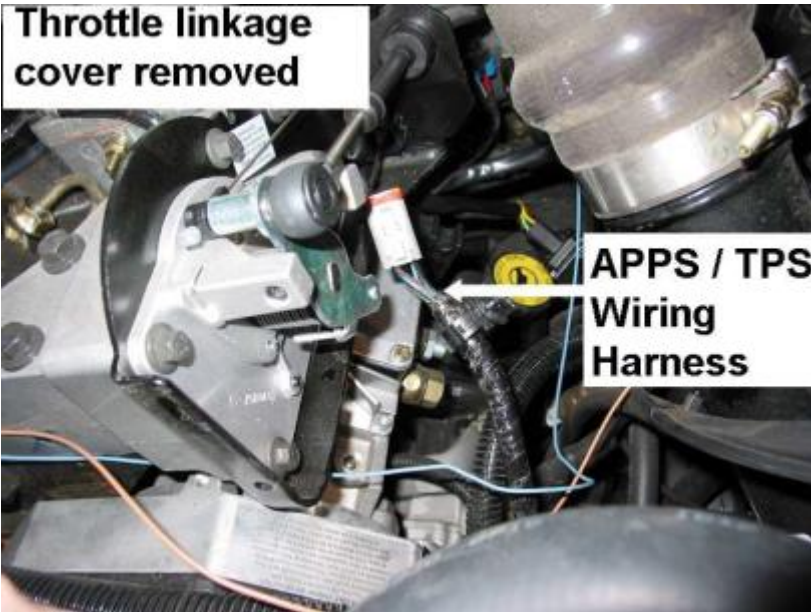

### Battery Tray Mounted APPS

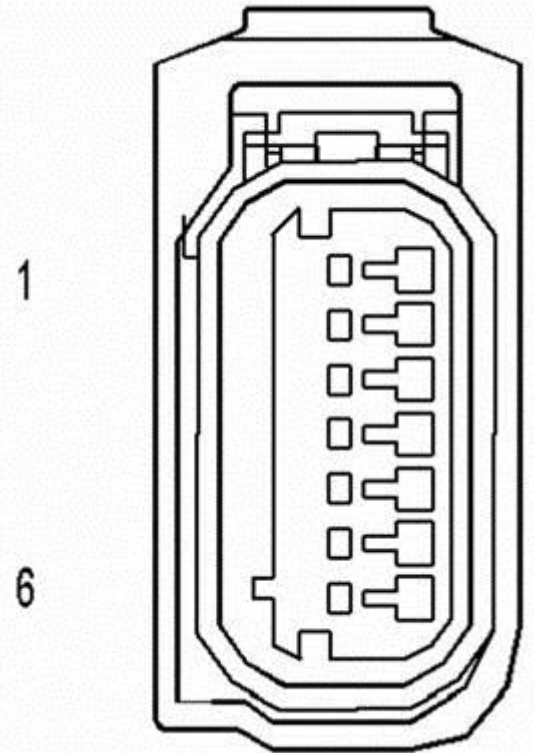
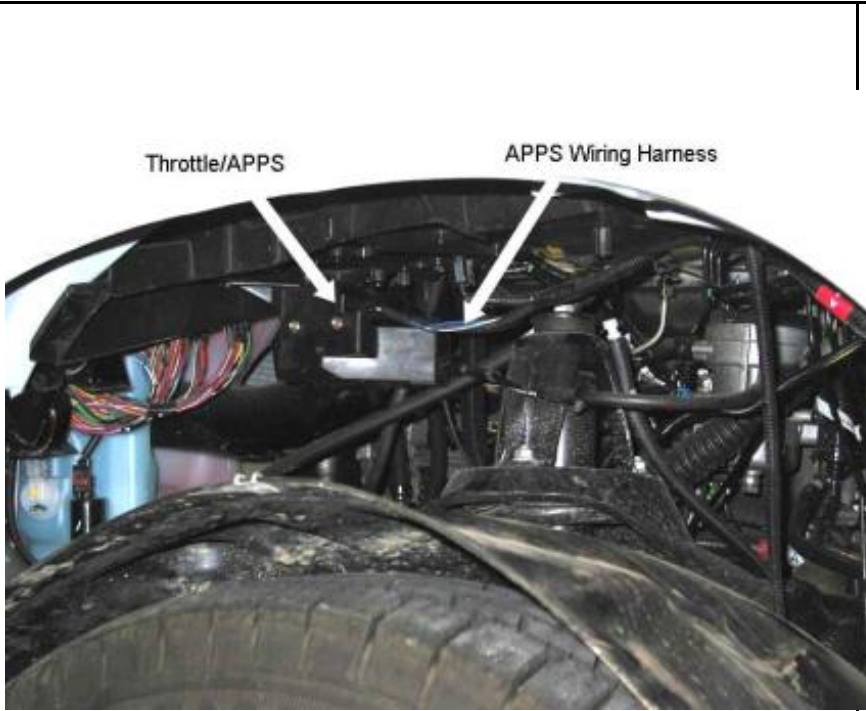

### Accelerator Pedal Position Sensor Wiring (2005)



sensor located on the accelerator pedal. Locate and connect a Posi-Tap to the correct wire color for your application. The yellow DFIV wire should now be connected to the correct APPS wire.

### APPS Location (Accelerator Pedal)

### APPS Plug

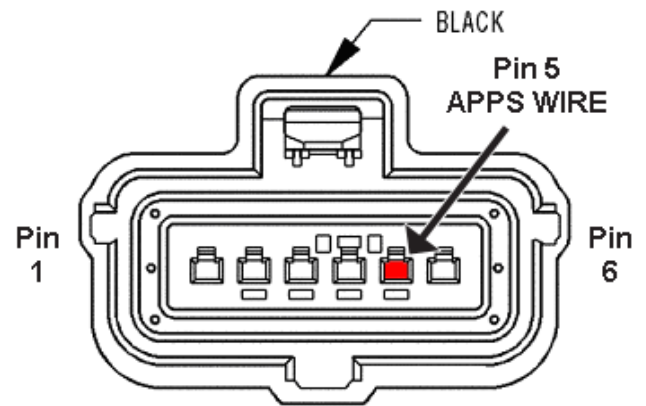
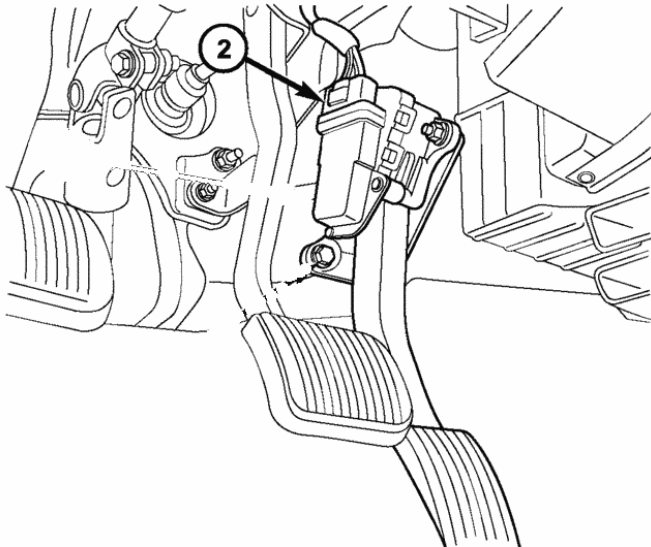

APPS Plug Pin	Circuit / Wire Color	Function
5	K23 20BR/WT	APPS NO. 1 SIGNAL

## Cruise Control Wiring Installation

*(Manual Transmissions & 2005 Automatics Only)*

To obtain access to the Cruise Control wiring harness, remove the lower steering column panel by removing the mounting screws and unsnapping the panel from the instrument panel.

Under the dash running vertical by the left of the steering column, locate the smaller wiring harness that runs out of the main harness. Remove some of the black electrical tape to gain access to the smaller wire bundle.

**\*\*\*DANGER\*\*\***

***THERE IS A BLACK WIRE WITH A TWISTED LIGHT BLUE/GREEN TRACER. DO NOT CONNECT OR TEST THIS WIRE AS IT IS CONNECTED TO THE AIR BAG SYSTEM AND THE BAG MAY DEPLOY CAUSING DAMAGE AND/OR INJURY.***

Vehicle	Cruise Control Wire Color	DFIV Wire color
2003 Dodge Manual Trans.	BK/LB	Blue
	R/LG	Green
2004–05 Dodge Manual Trans.	VT	Blue
	VT/BR	Green
2005 Dodge Auto Trans.	VT	Blue
	VT/BR	Green

Attach the supplied red (or gray) 18-22ga Posi-Taps™ to each correct wire and use the blue and green wires to connect them to the DFIV.

**2003 Vehicles**

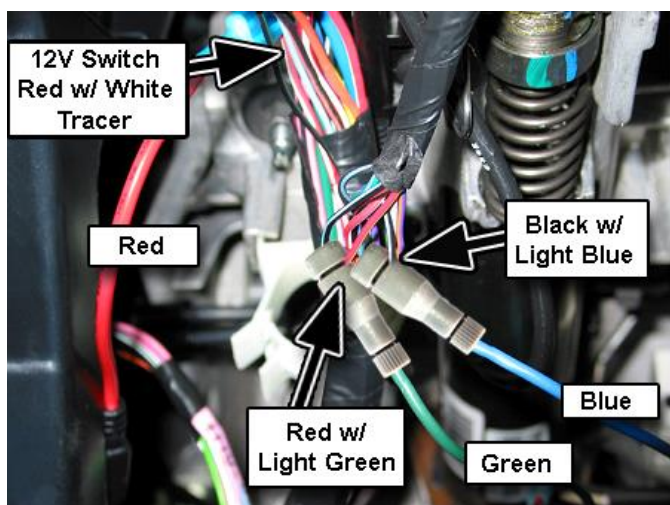

**2004+ Vehicles**



**Switch Install (Required if using toggle switch)**

If you wish to use an optional shifter mounted switch skip this step. See pages 21 and 22 for shifter switch install.

Remove attaching screws of the dashboard bezel and remove covering trim by pulling rearward on the corners of the trim panels.



**Note:** Placing the transmission all the way into 1<sup>st</sup>/low gear and ensuring the tilt steering is all the way down will allow for easy removal.

Pull the left hand and right hand dash panels away from their secured positions and let them hang.

Once the dash trim has been removed place it on a large working surface like a table or workbench.

Measure and mark a spot for the Toggle Switch 3/4" up from the bottom edge of the dash panel and 1" in from the left edge of the accessory panel as shown in the photo.



Drill a pilot hole with a 1/8" bit and finish by enlarging the hole with a Unibit to exactly 1/2".

**NOTE:** YOU MAY HAVE TO GRIND DOWN PART OF THE SUPPORT RIB ON THE BACK OF THE TRIM PANEL TO ACCOMMODATE THE SWITCH BODY.

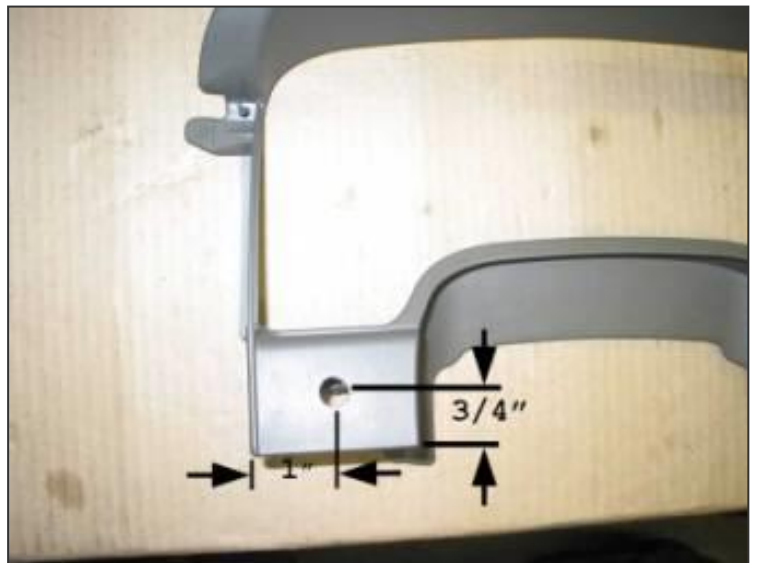



Install switch into drilled hole and secure with lock ring then reinstall dash trim panels by reversing the removal procedure.

Once the switch is installed, attach the ground wire to a good metal ground under the dash, or to ground terminal located on DFIV.

With a test light, locate a switched 12 Volt power source and install the supplied black (12-18ga) Posi-Tap™ to it then attach the red fused wire from the switch to this Posi-Tap™.

Run non-fused red wire from switch to the DFIV switch terminal.

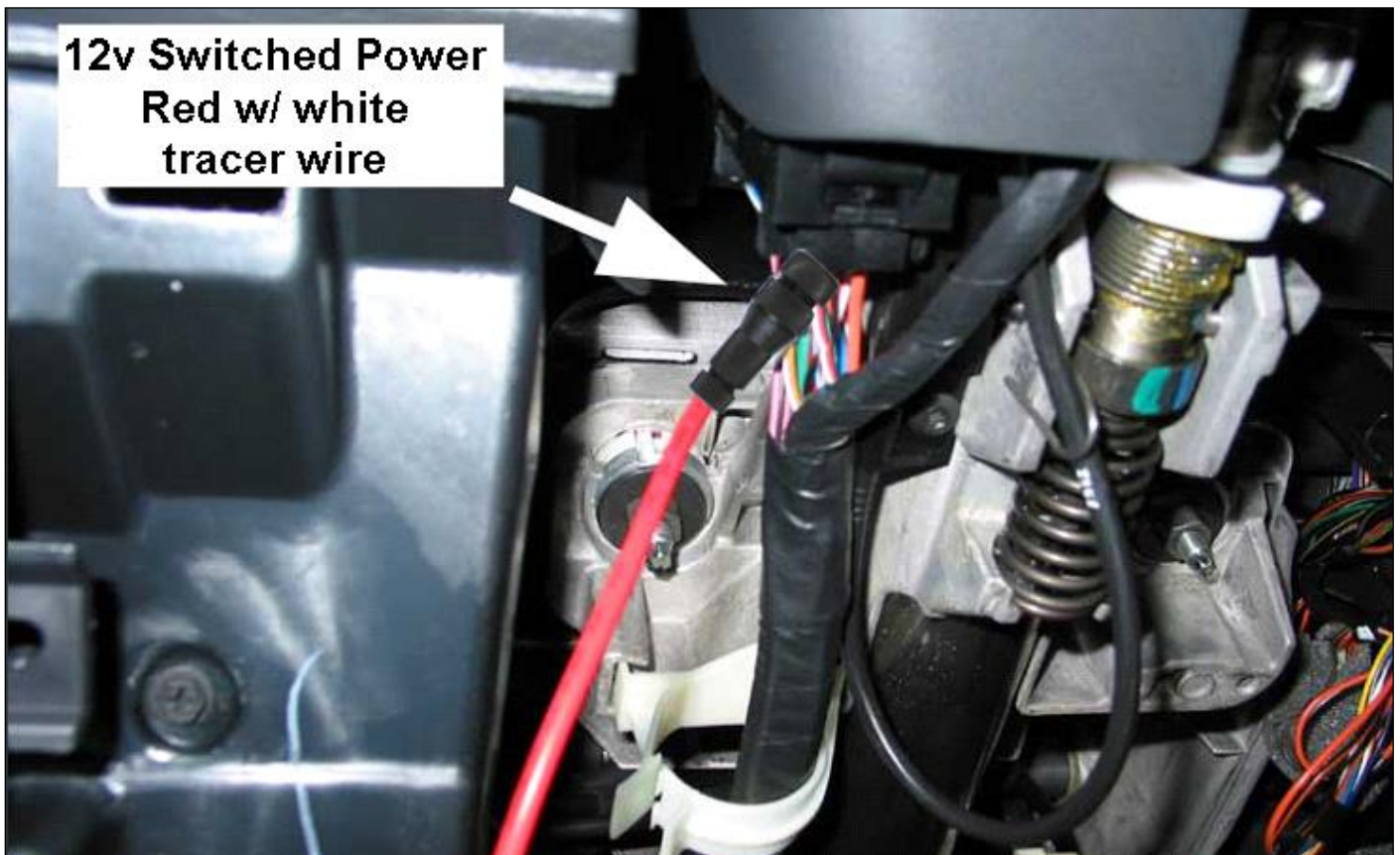

## ***Optional Manual Shifter Switch (Push-Pull Style)***

Mount the shifter switch onto the shift lever using the clamp supplied (either 5/8" or 3/4"). Run the electrical cable down the shifter shaft, securing the cable with zip-ties or electrical tape, and run it under the carpet to the firewall and under the dash to the relays, leaving enough slack for proper shifting of the transmission lever and to prevent any rubbing of wire.

At the end of the cable, cut off any excess and strip away about 1 to 2 inches of the black rubber covering exposing the black and white (or green) wires then strip the insulation from the ends of the two wires.



Connect the white (or green) wire to the "Switch" terminal on the DFIV.

Locate one of the ignition switch power fuses in the fuse panel underneath the steering column. Install the supplied fuse tap onto this fuse, crimp a female blade connector onto the black wire of the push-pull switch and plug the black wire onto the fuse tap.

Also provided in the kit is a Posi-Tap connector which can be used as an alternative to the fuse tap and flag connector. You can use the Posi-Tap to tap onto the 12 volt switched ignition wire that you used to power the DFIV. Or, locate one of the ignition switched red-black tracer wires under the steering column (one is a 10/12ga and the other is a 14/16ga) and connect an appropriate Posi-Tap connector to it (green for 10/12ga and black for 14/16ga wire). Connect the black wire of the push-pull switch to the Posi-Tap

## Optional Manual Shifter Switch (Rocker Switch Style)

Mount the shifter switch onto the shift lever using the clamp supplied (either 5/8" or 3/4"). Run the electrical cable down the shifter shaft, securing the cable with zip-ties or electrical tape, and run it under the carpet to the firewall and under the dash to the relays, leaving enough slack for proper shifting of the transmission lever and to prevent any rubbing of wire.

At the end of the cable, cut off any excess and strip away about 1-2" of the black rubber insulation exposing the black, white and green wires, then strip the insulation from the ends of the three wires.

Connect the green 12V output green wire to the "Switch" input terminal on the DFIV.

Attach the 5/16" ring connector to the black ground wire and attach it to a good ground nearby, or to the "ground" terminal of the DFIV.

Locate one of the ignition switched power fuses in the fuse panel underneath the steering column. Use the supplied fuse tap to supply ignition switched power to the "Keyed 12 Volts" (white) wire of the rocker switch assembly.

Also provided in the kit is a Posi-Tap connector which can be used as an alternative to the fuse tap and crimp connector. You can use the Posi-Tap to tap onto the 12 volt switched ignition wire that you used to power the DFIV. Or, locate one of the ignition switched red-black tracer wires under the steering column (one is a 10/12ga and the other is a 14/16ga) and connect an appropriate Posi-Tap connector to it (green for 10/12ga and black for 14/16ga wire). Connect the white wire of the rocker switch assembly to this Posi-Tap.

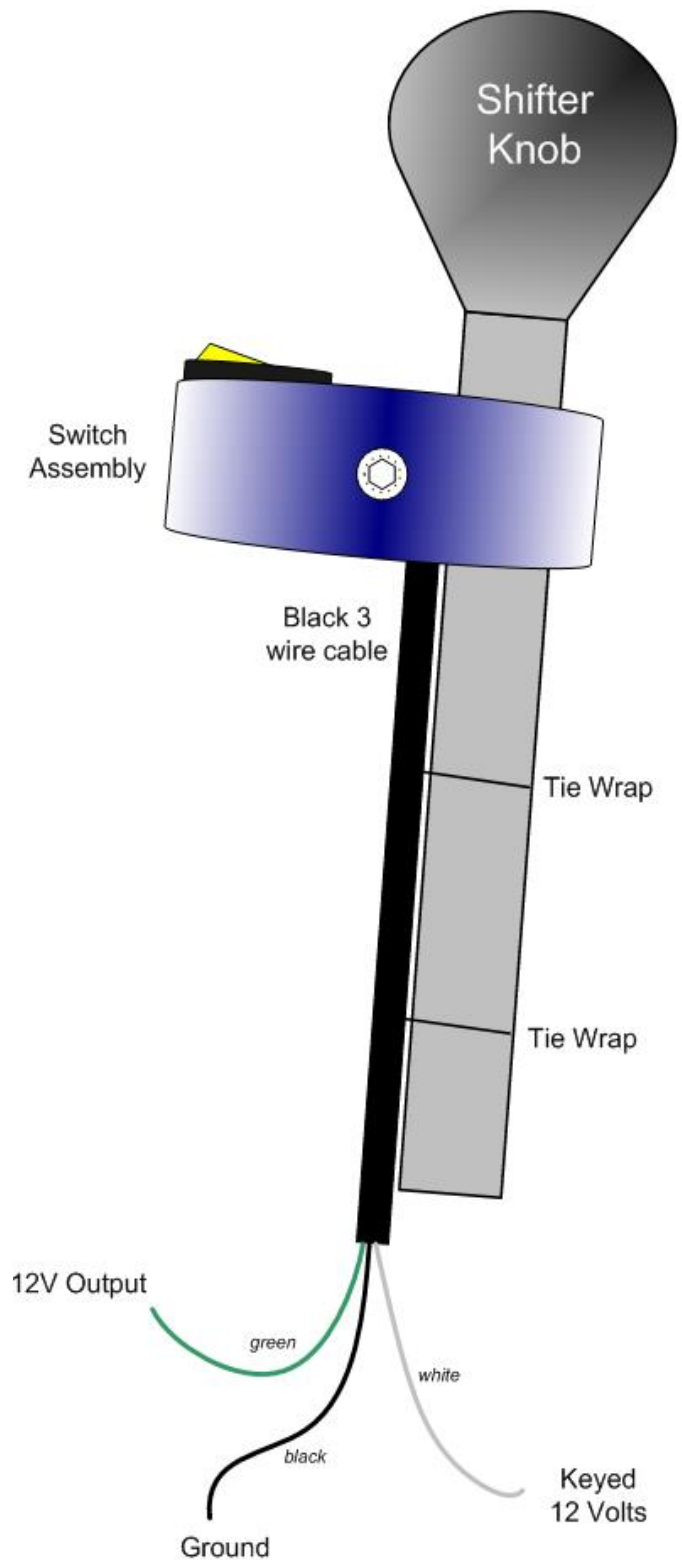

# Wiring & Plumbing Diagram

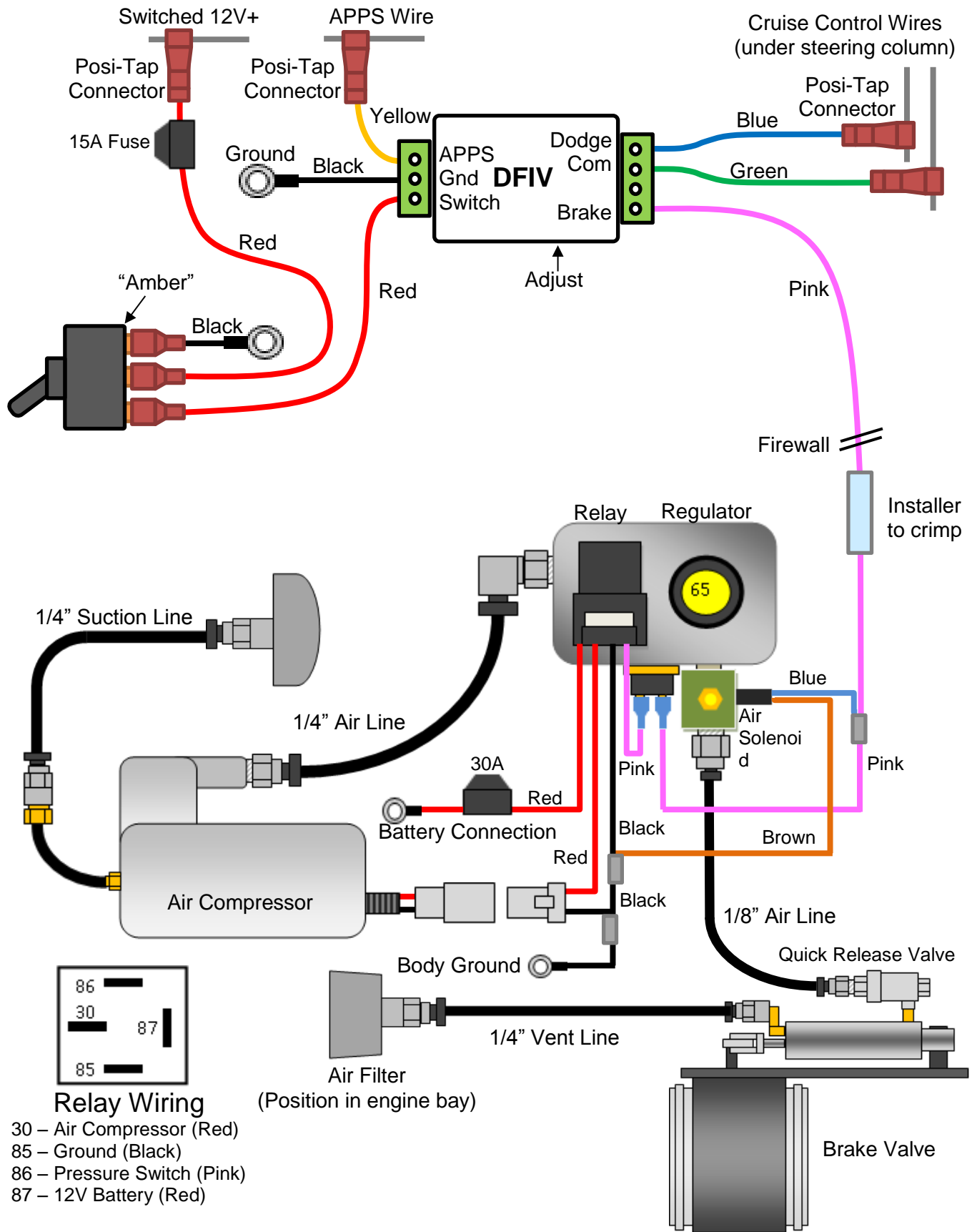

## DFIV Adjustment & Testing

To achieve the correct setting for the activation of the exhaust brake in relation to the throttle pedal the DFIV Module must be calibrated for your vehicle.

Connect one end of a test light to the "BRAKE" terminal of the DFIV module and the other end to a good ground.

With the throttle at idle, turn the key to run and turn on toggle switch (switch should light up). Then, using a small flat bladed screwdriver, turn the small adjusting screw in the DFIV Module counterclockwise or clockwise until the test light JUST turns on.



**CAUTION:** THE ADJUSTING SCREW IS A MICRO-SWITCH THAT IS VERY DELICATE, SO TURN USING SMALL ADJUSTMENTS

As the accelerator pedal is applied the test light should turn off just as the throttle comes off idle, indicating proper calibration of the DFIV Module with the APPS.

Then the test light should activate again when the throttle pedal returned to idle. If not, readjust the DFIV Module so that it does.

## DFIV Operation

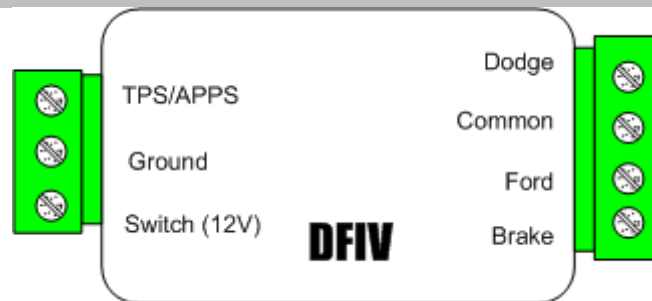

Input	Description
TPS/APPS	Locate the TPS/APPS wire from the Accelerator pedal position assembly. This wire is referred to as sensor circuit #1 on the rising signal circuit, and should rise linearly in voltage with the amount of throttle depressed. Typical values range from 0.5 Volts and rise to 4.5 Volts.
Ground	Connect to Vehicle electrical ground
Switch (12V)	This connection will supply 12 volt power to the DFIV. This will come from the toggle or shifter switch.
Dodge	This input should only be used for Dodge applications as it disables the cruise control specifically for Dodge trucks.
Common	Common cruise inputs between the Dodge and Ford inputs.
Ford	This input can be used for other generic applications. When the brake is activated the connection between the Ford input and the Common is severed.
Brake	You should have 12 volts at this terminal when the key is in "run", the brake switch is on and the throttle is at idle. There should be no power at this terminal if any of those conditions are not met.



## **Exhaust Back Pressure Testing for Air Actuated Brakes**

To test exhaust brake system pressure, a minimum 0-100psi pressure gauge is required.

We recommend purchase of a BD brake pressure gauge kit #1030050.



**You do not need to measure the air pressure in the system, just the exhaust backpressure, which is located on the cast valve.**



### **Idle Pressure Test**

With the BD brake engaged and the engine at idle check the exhaust backpressure using a pressure gauge (such as BD PN 1030050) at the test port on the brake valve.

If the back pressure is below 13 psi at idle you have a number of likely causes. The most common being an exhaust leak either at the clamp joint or at the welds (only on some models). Apply the exhaust brake and have someone assist you looking for soot trails or the visible leak. Another culprit would be an exhaust manifold leak, turbocharger gasket leak, turbocharger problem or an EGR issue.

If the back pressure is greater than 25psi, you will need to make an adjustment on the stop bolt. Loosen the jam nut, and lengthen the stop bolt towards the actuator, this will shorten the stroke distance. Only turn 1/4 rotation at a time and re-secure the jam nut. Retest idle pressure.

**NOTE: The brake stop-bolt and regulator have been preset at the factory and should not need to be adjusted.**

We generally do not recommend adjusting the stop bolt, please consult BD before doing this as it may void your warranty.

## Off-Idle Pressure Test & Adjustment

Your BD exhaust brake is a variable-orifice design so when the brake is active and the engine is at higher RPM the brake lever does not rest on the stop bolt. Off-idle backpressure is set by adjusting the air pressure regulator which will in turn increase or decrease off-idle exhaust backpressure. You will need to secure your pressure gauge somewhere that you can see it while you are driving. Using a long extension hose & bringing the gauge into the cab through an open window or clipping it under a windshield wiper works well.

Get the truck up to speed (a downhill grade or a load in the truck is helpful) and activate the exhaust brake. Note the maximum backpressure achieved. You should get peak backpressure at higher RPM (try 3000 RPM in Drive). If you cannot reach the desired backpressure (compare table below) you can begin troubleshooting, the first step is to look for exhaust leaks either from the clamps, exhaust manifolds or feed pipes. Also look for leaks at the clamps located at the back of the turbo and also at the down pipe. If all connections are sealed, you can then use the adjusting regulator to increase the backpressure. Note that small regulator adjustments can have a significant effect on off-idle backpressure.

Turning the regulator **clockwise** will increase pressure.

Turning the regulator **counter clockwise** will decrease pressure.



**NOTE:** Over the next two weeks, the backpressure at idle may rise due to initial carbon build up on the inside of the brake housing and on the butterfly. The stop bolt may need to be adjusted again to compensate.

Application	Maximum Back Pressure
GM/Chevy 6.5	35 psi
GM/Chevy Duramax	55 psi
Ford Powerstroke	45 psi
Dodge Cummins 1988-98 12V w/o 60lbs Springs	40 psi
Dodge Cummins 1988-98 12V with 60lbs Springs	60 psi
Dodge Cummins 1998 to current	65 psi

\*HD Spring part# is 1030060.

**CAUTION:** Do NOT exceed the maximum back pressure value in the exhaust system. Exceeding this pressure will force the exhaust valves open during the intake stroke which could cause engine damage.

## **Maintenance**

To extend life of the exhaust brake, do not operate the vehicle for extended periods of time without activating the brake. We suggest activating the exhaust brake at least a couple times a day while operating the vehicle to prevent any carbon or rust build up on inner parts of the brake valve assembly.

The hoses, wires, fittings and clamps should be inspected on a regular basis for any deterioration, damage or leaks.

**To increase the life of your exhaust brake, we recommend daily operation. By simply switching the brake on and off a couple times a day, it will prevent the butterfly valve from sticking due to carbon build-up.**

## Air Brake Troubleshooting Guide

This guide assumes that your exhaust brake system is using a DFIV and a BD air compressor. If your system uses a micro switch for throttle activation, the operation of the air solenoid and pump are the same as with the DFIV. If you are using existing on-board air, check that system as appropriate.

<b>When I let off the throttle nothing happens.</b>	<b><u>No</u></b>	<b><u>Yes</u></b>
Is the DFIV powering its "brake" output when the throttle is at idle and brake switch and ignition are both on?	<p>Check if DFIV has good power, ground and throttle signal. Check DFIV adjustment. If these things check out, but the DFIV won't power the "brake" output, the DFIV is likely faulty.</p> <p>Also check power &amp; ground at pump relay and make sure the air solenoid has a good ground.</p>	<p>Check that when air solenoid is powered it will allow air to flow from the #2 port out the #1 port.</p> <p>Check that pump relay is powering pump. If pump has power but does not run, pump is likely faulty. Check for power &amp; ground at pump relay, if these are good but relay does not click or does not power pump, relay is likely faulty.</p>
<b>The brake comes on but there's little or no holdback</b>	<b><u>No</u></b>	<b><u>Yes</u></b>
<p>See if torque converter is staying locked up during deceleration. If not, the engine RPM will fall to idle when the throttle is released. The brake will be ineffective without the torque converter locked up.</p> <p>Check off idle brake pressure. (See back pressure chart) Are you getting maximum allowable backpressure?</p>	<p>Check for exhaust leaks. A small leak can result in a significant decrease in back pressure. If no leaks are found try adjusting air regulator. Check for air leaks in brake system.</p>	<p>Try down shifting more aggressively. More RPM will give more holdback. Transmission or torque converter could be slipping internally.</p>
<b>Everything seems to work, but the brake valve won't close.</b>	<b><u>No</u></b>	<b><u>Yes</u></b>
Check that air is reaching brake air cylinder?	Air solenoid or quick release valve are likely stuck, plugged or faulty. Clean or replace as required.	Cylinder or brake valve are seized. Remove the clevis pin on the end of the cylinder rod & see if the valve lever can be moved freely.
The valve lever can be moved freely?	Try dismounting the brake & cleaning the carbon out of it. If this does not work the brake valve will need to be replaced.	The cylinder is stuck and will need to be replaced.
<b>Problem</b>	<b>Solution</b>	
Air compressor runs in short bursts and brake is slow to apply.	There is a restriction in the air system, normally in the regulator or air solenoid. Remove the fittings from the regulator and air solenoid, you will likely find some corrosion or debris caught in them. Clean this out with a pick, small brush, compressed air and WD40 or similar lubricant.	
Air compressor runs continually.	Pump relay is likely stuck on. Check operation of relay & replace as required.	
Brake is slow to release.	Debris or corrosion is restricting the quick release valve or air solenoid. Clean as required. Air solenoid could be too far from brake.	