

BD Remote Mount Exhaust Brake 2006-07 Dodge Installation Instructions

BD P/N	Application
2027330	2006-2007 Dodge Cummins 5.9L

***** Please read this manual before starting installation. *****

OWNER'S MANUAL - LEAVE IN GLOVE BOX









The brake pressure at idle must be checked and adjusted at time of install, at least two weeks after install, and at regular twice a year intervals.

Table of Contents

Kit Contents	3
Introduction	4
Optional Accessories.....	4
Notes on Connectors	4
Tools Required	5
Installation	5
Brake Valve Installation	5
Air Hose Installation	7
Air Compressor Mounting Installation	8
Regulator Installation	11
Regulator Plumbing and Electrical	11
ECM Activation Wire Install	14
Switch Install (Required if using main toggle switch)	15
Optional Manual Shifter Switch (Push-Pull Style).....	17
Optional Manual Shifter Switch (Rocker Switch Style).....	18
Attaching the switch relay	19
Wiring With The Default Toggle Switch	19
Wiring With The Rocker Switch (Manual Trans)	19
Wiring & Plumbing Diagrams.....	20
Using Main Toggle Switch Only.....	20
Using Push/Pull Shifter Switch (Manual Trans).....	21
Using Rocker Switch (Manual Trans).....	22
Exhaust Back Pressure Testing for Air Actuated Brakes	23
Idle Pressure Test.....	23
Off-Idle Pressure Test & Adjustment	24
Maintenance.....	25
Air Brake Troubleshooting Guide	26

Kit Contents

Please check to make sure that you have received all parts for your kit

1127038-A	1030129-D	1220113-A
		
<i>Valve Assembly</i>	<i>Compressor Assembly</i>	<i>Air Tubing Assembly</i>
Qty: 1	Qty: 1	Qty: 1
1100400	1100404	1100740
		
<i>4" Pipe Adapter</i>	<i>4" Marmon Clamp</i>	<i>4" S/S Exhaust Clamp</i>
Qty: 2	Qty: 2	Qty: 1
1300131	1321031	1220131-C
		
<i>6" Tie Wraps</i>	<i>Toggle Switch Kit</i>	<i>Regulator/Control Assy.</i>
Qty: 12	Qty: 1	Qty: 1

Introduction

Thank you for purchasing a BD Exhaust Brake.

This exhaust brake kit installs inline in the exhaust pipe downstream from the turbocharger. It is intended for applications where the stock turbocharger has been removed or changed, and the turbo mount version of the BD Exhaust Brake cannot be installed. This kit requires the vehicle have a 4" exhaust pipe for installation.

This manual is divided into different areas to assist you with the installation and operation of your braking unit. We strongly suggest that you write down the kit and serial numbers of your unit in the spaces provided and retain this manual for any future reference.

Optional Accessories

Description	Part #
Manual Transmission Shifter Switch Kit	1300210 or 1030900
AutoLoc Converter Lock-up Kit	1030390
Torqloc Converter Lock-up Kit	1030395
Performance BD Valve Body	CALL
Brake pressure gauge kit	1030050

Notes on Connectors

The kit includes a number of Posi-Tap™ connectors (Gray or Red/Black/Green or Yellow) to tap onto OEM wiring. It is important to select the correct color of connector so that it matches the gauge of the OEM wire that it is being installed on. Using the incorrect connector could cause an inadequate connection and/or the OEM wire could be severed.

OEM Wire	Posi-Tap™ Color
18-22ga	Gray or Red
12-18ga	Black
10-12ga	Green or Yellow

Though these connectors offer a quicker installation, the best option would be to solder the wires and isolate the joints with heat shrink or liquid electrical tape. Proper soldering techniques should be used to ensure adequate connections.

Posi-Tap™ Connector Usage Diagram

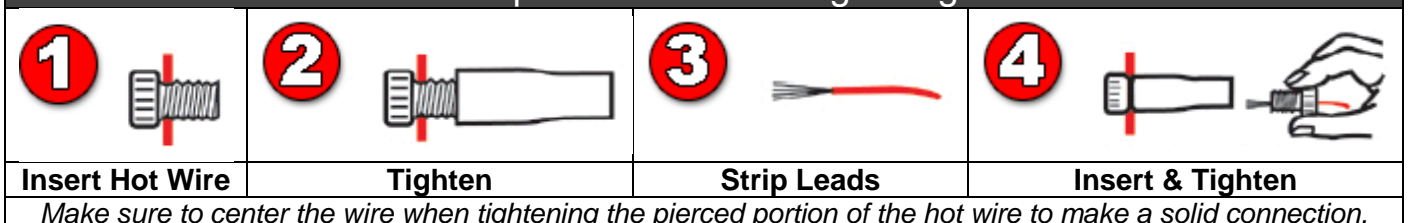

The ground terminals of the vehicle's batteries should be disconnected before performing any piercing/posi-tapping onto any ECM/PCM wire.

Tools Required

- Measuring tape or ruler
- Reciprocating saw or hacksaw
- Wire Crimping Pliers
- Drill with 1/8", 3/16" bits and Uni-bit
- Small bladed flat tip screwdriver
- Socket Set
- Welder
- Heat gun or lighter
- Test light

Installation

To prevent damage to electronic components, it is recommended that both battery negative terminals be disconnected while working on the vehicle.

Please read this manual thoroughly before installing this exhaust brake.



Raise and support the vehicle with a vehicle hoist or with appropriate jack stands. Ensure vehicle is safely supported before proceeding to reduce possibility of damage or injury.

Brake Valve Installation

From underneath the vehicle, locate the turbo down pipe and the catalytic converter. You will need to cut a 7-1/4" section from this pipe. Although the pipe has a number of unusual bends, you will need to choose the straightest section possible, especially for the rear adapter of the brake, as this is a SS band clamp. As well mock up the installation of the brake so that when the brake cycles, the actuator will not come in contact with anything. Use a Sawsall or cutting disc to remove this section.

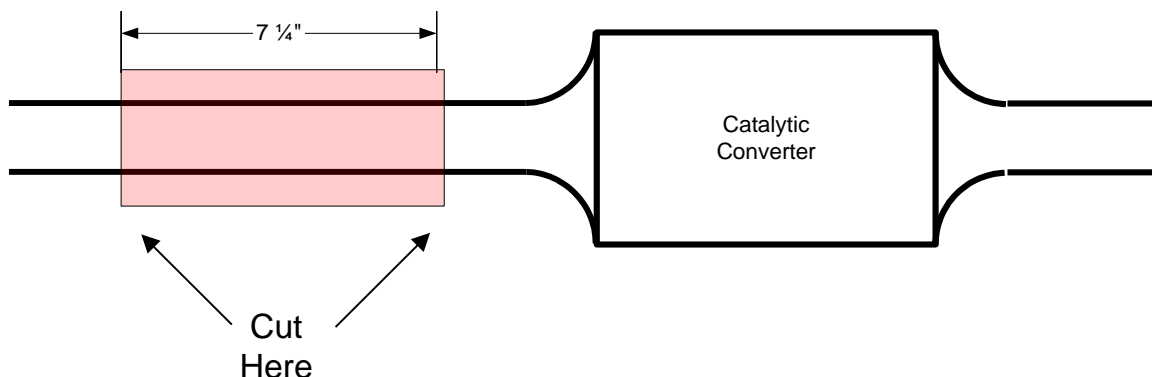

Clean off the cut ends of the intermediate pipe with a file to remove burrs left from cutting and then insert the adapter pipes onto each end of the now exposed pipes.

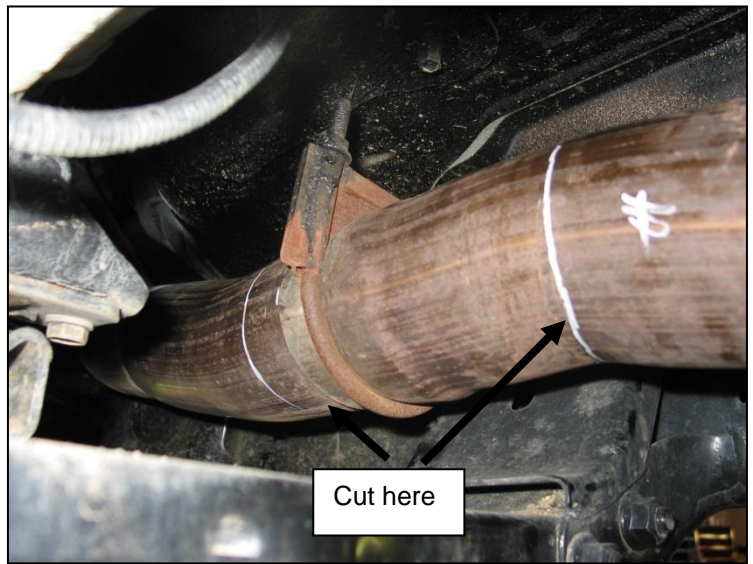

Insert the exhaust brake and secure with supplied 'V' band clamps. Be sure that the air cylinder bracket extends toward the rear of the vehicle.

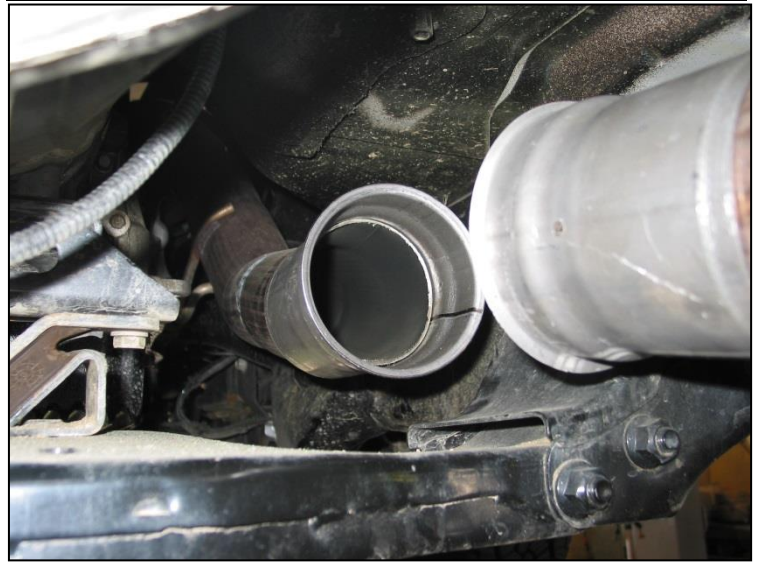

Ensure the exhaust brake and rear exhaust sections are pushed all the way forward on the front pipe so that the front adapter flange is up against the stop that is on top of the front pipe section then WELD the front adapter in place. Install the rear adapter to the pipe using the supplied band clamp.



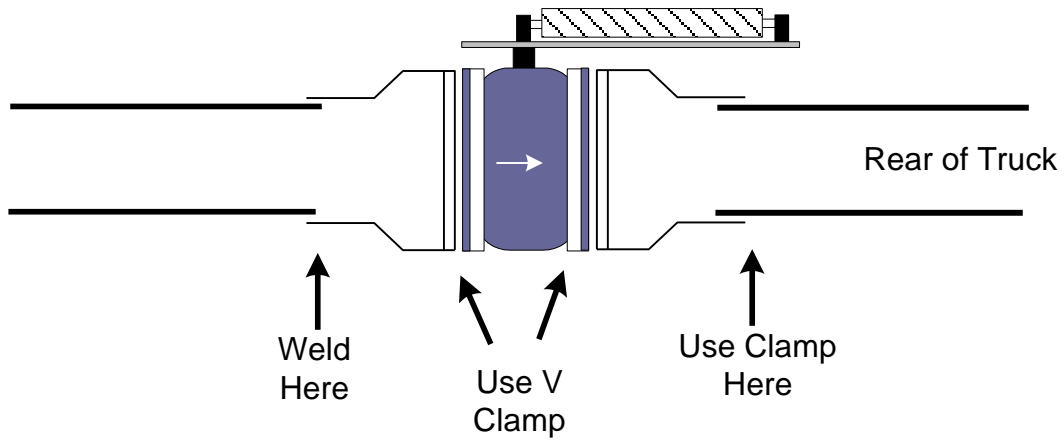

IMPORTANT The front exhaust connection **MUST** be welded. Using a band clamp or conventional exhaust clamp on this joint will cause leaks and will not retain full exhaust brake pressures.

Air Hose Installation

This kit is supplied with a premade air tubing assembly. The 1/8" air tube is the pressurized air feed to the brake pneumatic cylinder and the 1/4" air tube is the vent line for the cylinder.



Insert the 1/8" air tube into the quick connect fitting on the quick release valve on the air cylinder.

Insert the 1/4" tube into the vent-side quick connect fitting.

Feed the air tubing assembly over the top of the frame rail and support it so that there is no stress on the air tubes where they enter the brake valve.

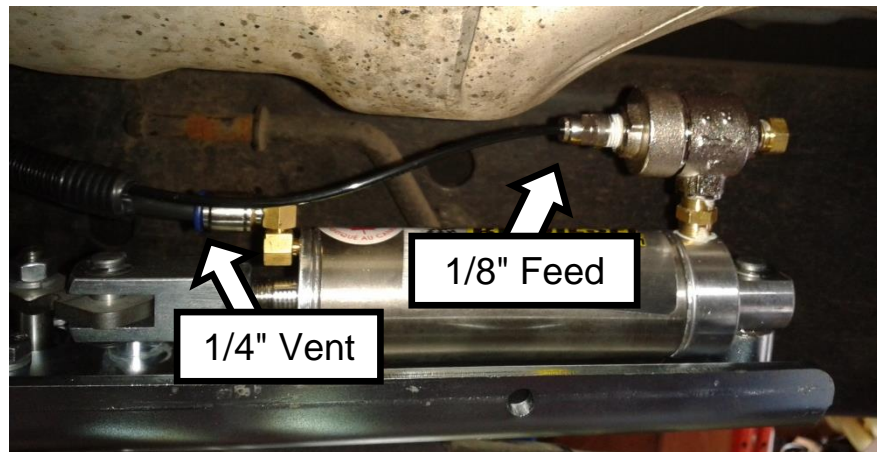

Route the air tubing assembly along the frame rail and secure with wire ties to the existing wiring harness.

Route the other end of the assembly into the engine bay up the passenger side of the firewall. It will be connected later.

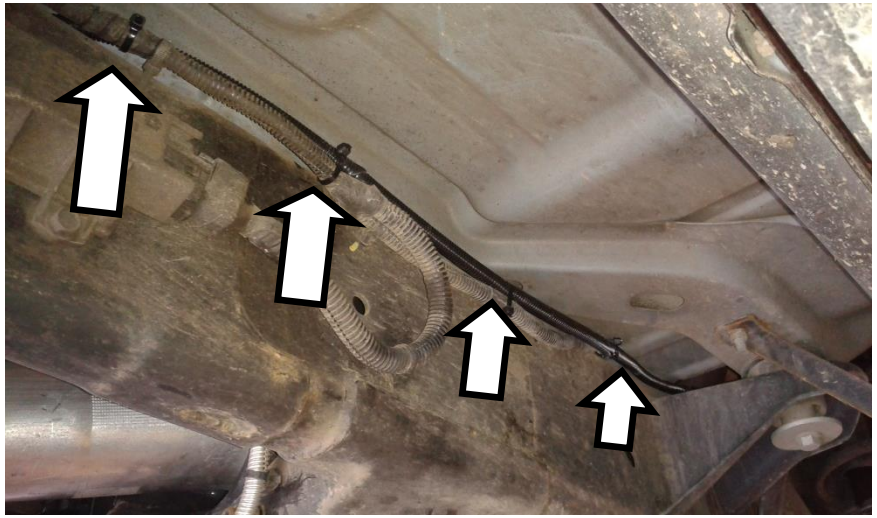

Air Compressor Mounting Installation

Remove the passenger side front wheel and remove the plastic fender liner from the vehicle to gain access to the inner fender area.

Install the supplied vibration dampening foam tape to the bottom back side of the compressor bracket assembly.



Locate the two mounting points for the compressor.

The compressor bracket is designed to line up with the front hood hinge bolt and an existing hole in the inner fender.

Remove the hood hinge bolt now to allow for installation of the compressor bracket.

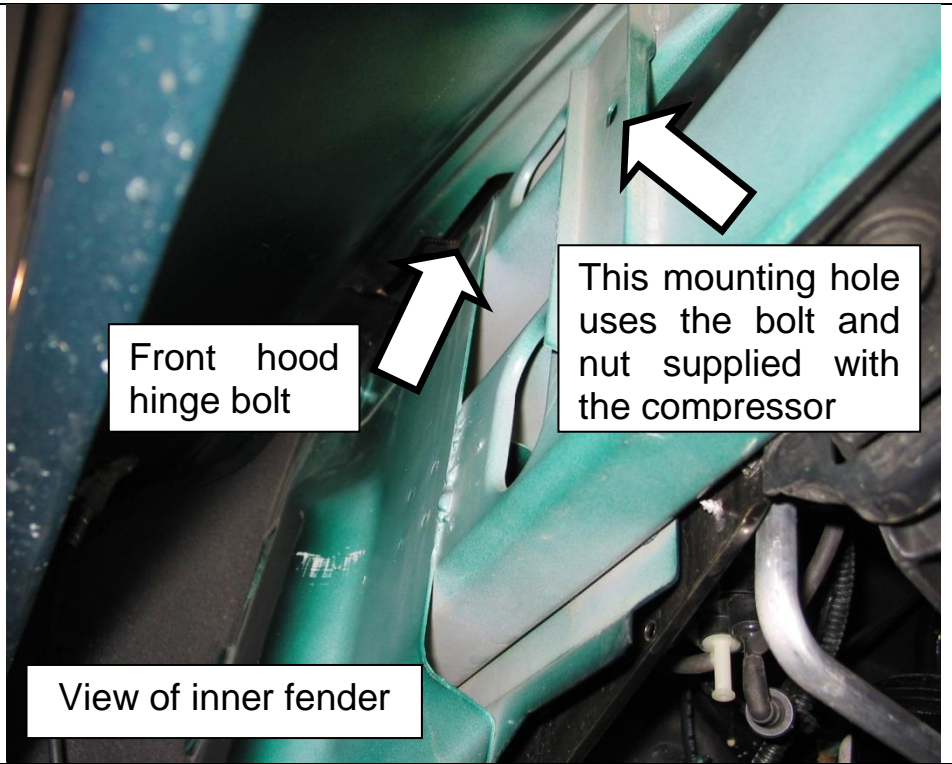

Front hood hinge bolt

This mounting hole uses the bolt and nut supplied with the compressor

View of inner fender

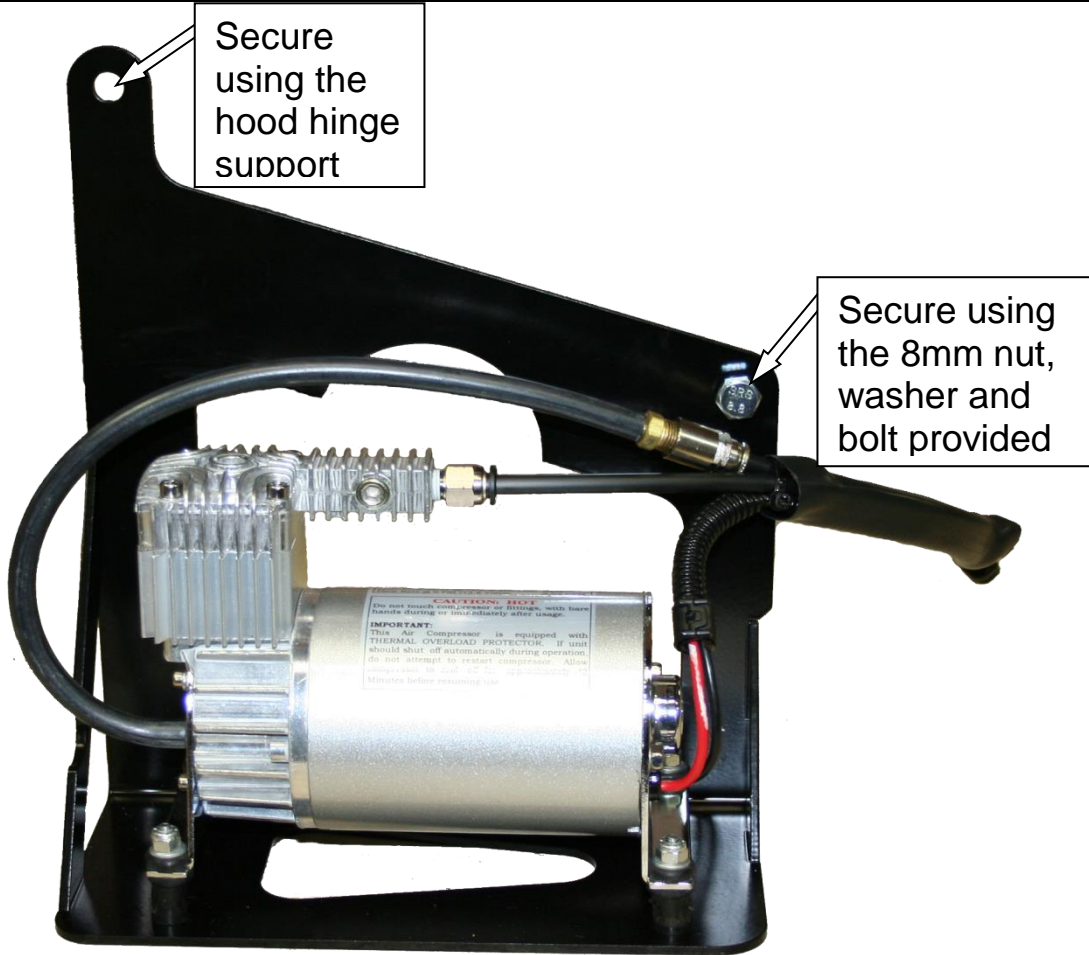

Secure using the hood hinge support

Secure using the 8mm nut, washer and bolt provided

CAUTION: HOSE
Do not touch hose directly or fittings, will become hot during or immediately after usage.
IMPORTANT:
This Air Compressor is equipped with THERMAL OVERLOAD PROTECTOR. If unit should shut off automatically during operation, do not attempt to restart compressor. Allow compressor to cool for 15-20 minutes before resuming use.

Feed the compressor air lines and wire through the fender into the engine bay, they will be connected later. Lift the compressor into place.



Secure the compressor in place by reinstalling the hood hinge bolt through the compressor bracket. Then install the nut and bolt to hold the front of the bracket.



While the fender liner is off, double check that the air tubing assembly installed in the earlier section is well clear of the exhaust pipe, turbocharger and moving suspension components.

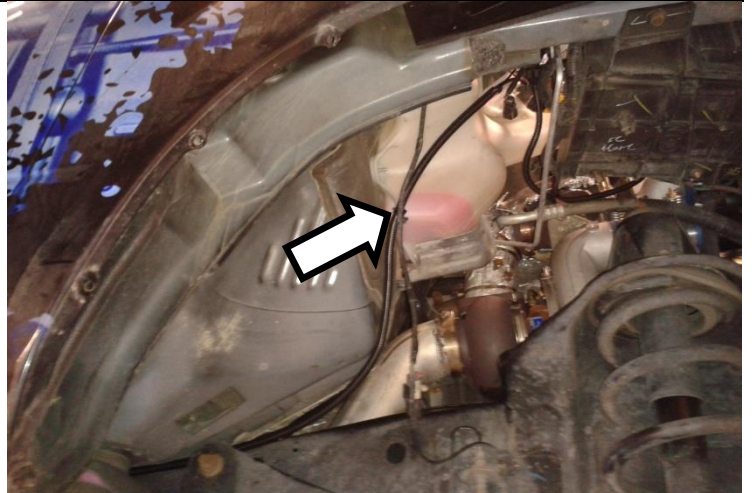

Regulator Installation

The air pressure regulator assembly is to be mounted at the top of the firewall on the passenger side of the engine bay. The included washer should go directly under the head of the screw to sandwich the sheet metal against the regulator bracket.

Locate the large oval hole on the passenger side of the vehicle near the upper cowlings of the firewall. To the right of this you can either drill a 3/8" hole or use the existing hole by removing the factory plastic locking insert.

Install the regulator assembly underneath the hole (shown on figure to the right). The lock washer and flat washer should be installed on top of the plastic cowling with the Phillips screw holding everything in place.

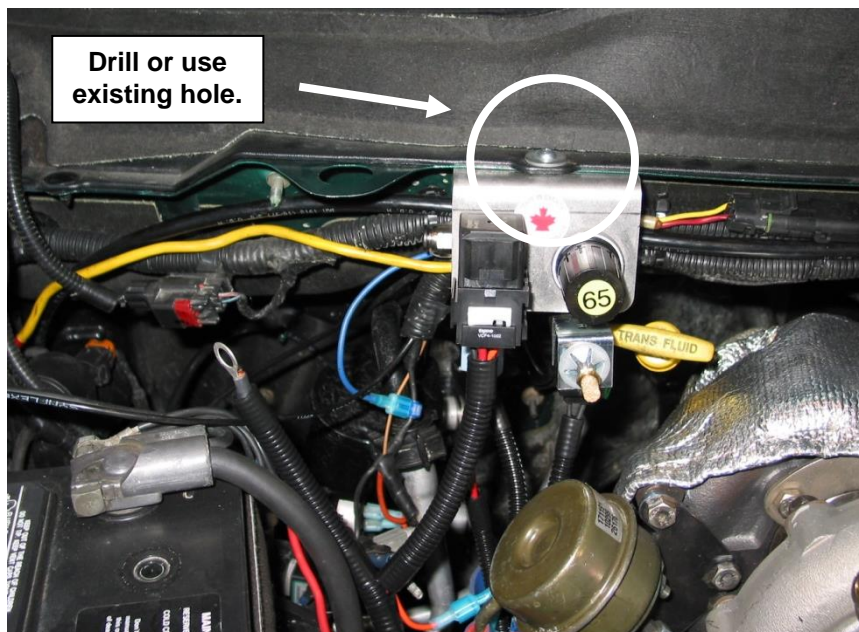

Regulator Plumbing and Electrical

Connect the air pressure line from the pump to the inlet of the regulator assembly.

This is the shorter of the two 1/4" tubes from the compressor that does not have a fitting on the end. This connects to the passenger side of the regulator assembly, behind the relay.

Trim this tube to length and insert it into the fitting.

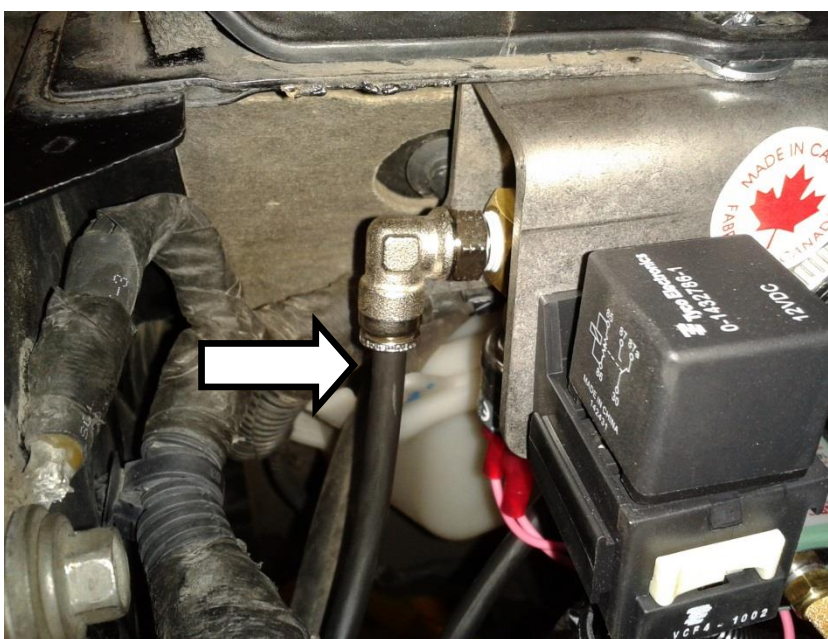

The other line from the compressor is the air suction line. This line is 1/4" diameter and comes with a preinstalled threaded adapter. Install the threaded filter supplied with the air pump into this fitting.



Route both the 1/4" suction line from the air pump and the 1/4" vent line from the air cylinder tube assembly to the driver side of the engine bay.

Secure with zip ties to keep the lines up off the motor.

Trim tubes to length if required.

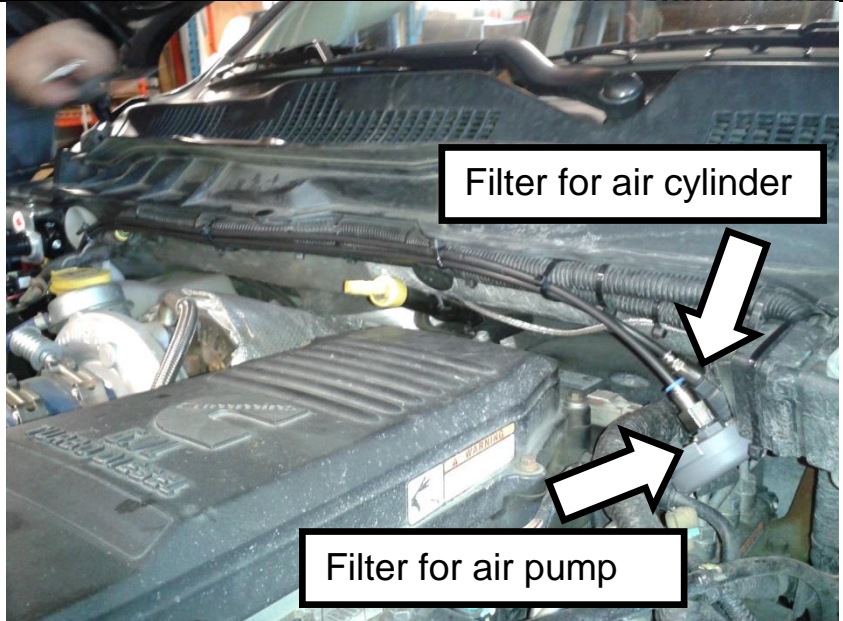

The preferred method of mounting the compressor air filter is just below the hood using a factory mounting location.

The sound deadening material is retained with plastic push in retainers. Remove this retainer and reinstall the air filter using its integral push in clip.



Locate the 1/8" tube from in the air tubing assembly that leads to the brake valve. This will be installed in the output from the air regulator assembly on the bottom of the solenoid.

Trim this tube to length and install it in the 1/8" fitting.

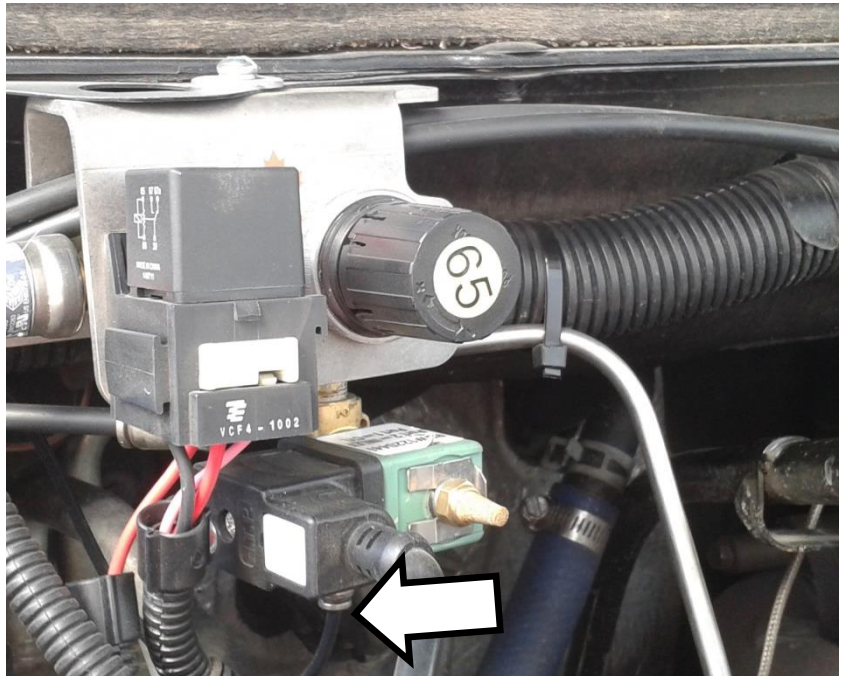

Connect the main ground connection to the body ground on the passenger side of the engine bay near the regulator assembly.

This is the black wire with a ring terminal installed on the end.

Alternatively this may be connected directly to the battery negative terminal if desired.

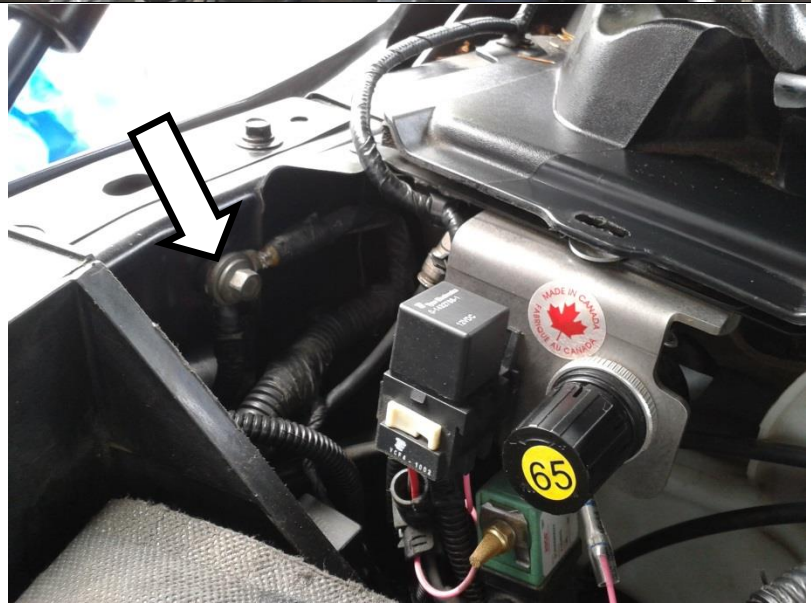

Connect the main power feed to the passenger side positive battery terminal clamp.

This is the red wire with a ring terminal installed on the end.

Connect the two pin gray connector from the regulator assembly to the air compressor. Refer to the next section for the wiring of the ECM activation wiring.

ECM Activation Wire Install

There are two separate ECM wiring blocks on the ECM, located on the driver's side of the engine – one 60-pin connector and a 50-pin connector.

Remove the 50-pin connector (#3 on picture to the right).

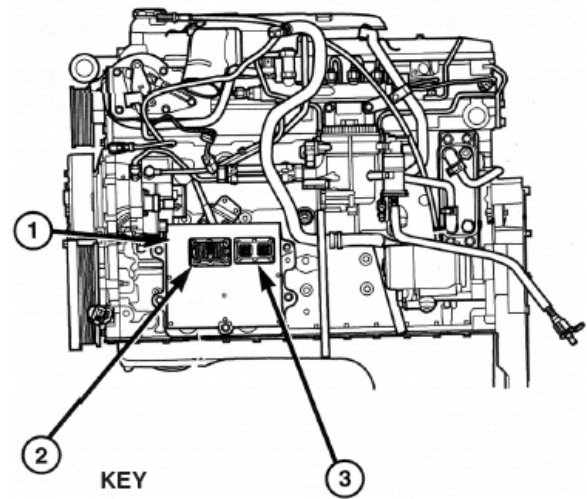

KEY

1. Engine Control Module (ECM)
2. 60-Way Connector
3. 50-Way Connector

Locate Pin #39 (for the activation wire from the cab) and Pin #42 (for the black wire in the control harness). These pins have a plug in them from the factory, which will have to be removed.

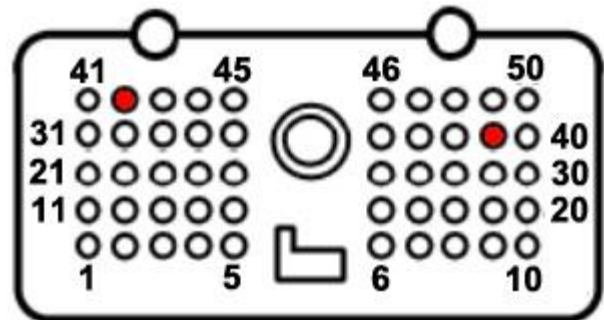

For this step you will need a pair of needle-nose pliers and a paper clip. Bend out the paper clip enough so that there is a straight shaft.

The easiest way to remove the OEM plug pins is to take the paper clip and insert it into the bottom end of the pin connector hole. This will poke out the top of the plug which then can be removed with pliers.

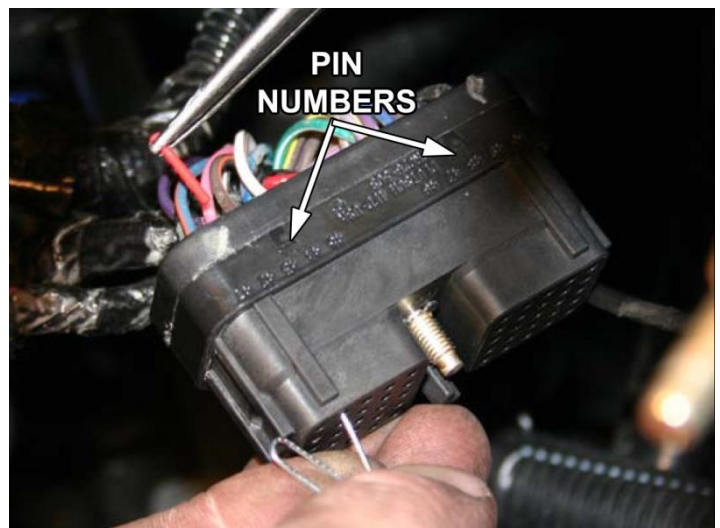

The two wire leads from the regulator assembly harness (with the ECM pins pre-crimped) can now be plugged into the ECM. Insert the tan wire into Pin #39, and the black wire to Pin #42. They should snap into place. Once this is complete, you can re-install the ECM plug. Secure the wiring loom using the supplied tie wraps.

Switch Install (Required if using main toggle switch)

Remove attaching screws of the dashboard bezel and remove covering trim by pulling rearward on the corners of the trim panels.



Note: Placing the transmission all the way into 1st/low gear and ensuring the tilt steering is all the way down will allow for easy removal.

Pull the left hand and right hand dash panels away from their secured positions and let them hang.



Once the dash trim has been removed place it on a large working surface like a table or workbench.

Measure and mark a spot for the Toggle Switch 3/4" up from the bottom edge of the dash panel and 1" in from the left edge of the accessory panel as shown in the photo.

Drill a pilot hole with a 1/8" bit and finish by enlarging the hole with a Unibit to exactly 1/2".

NOTE: YOU MAY HAVE TO GRIND DOWN PART OF THE SUPPORT RIB ON THE BACK OF THE TRIM PANEL TO ACCOMMODATE THE SWITCH BODY.

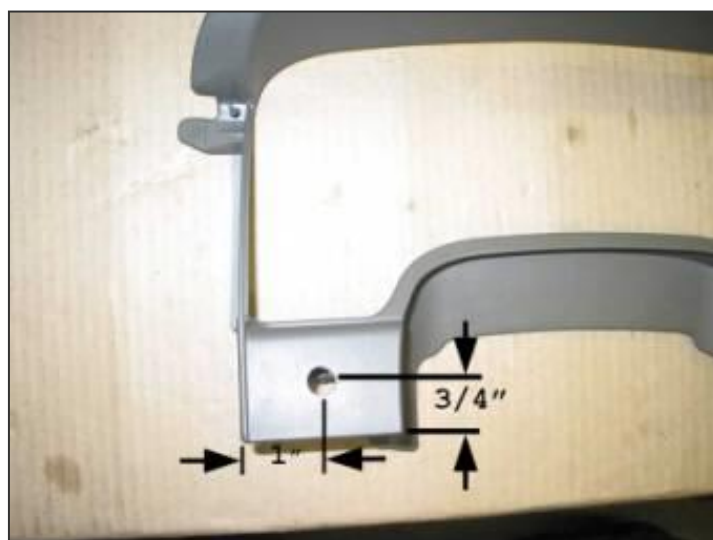



Install the switch into the drilled hole and secure it with the plastic lock ring. Reinstall the dash trim panels by reversing the removal procedure.

Once the switch is installed, attach the ground wire to a good metal ground under the dash.

With a test light, locate a switched 12 Volt power source (quite frequently a pink w/ white tracer wire) and install the supplied black (12-18ga) Posi-Tap™ to it then attach the red fused wire from the switch to this Posi-Tap™.

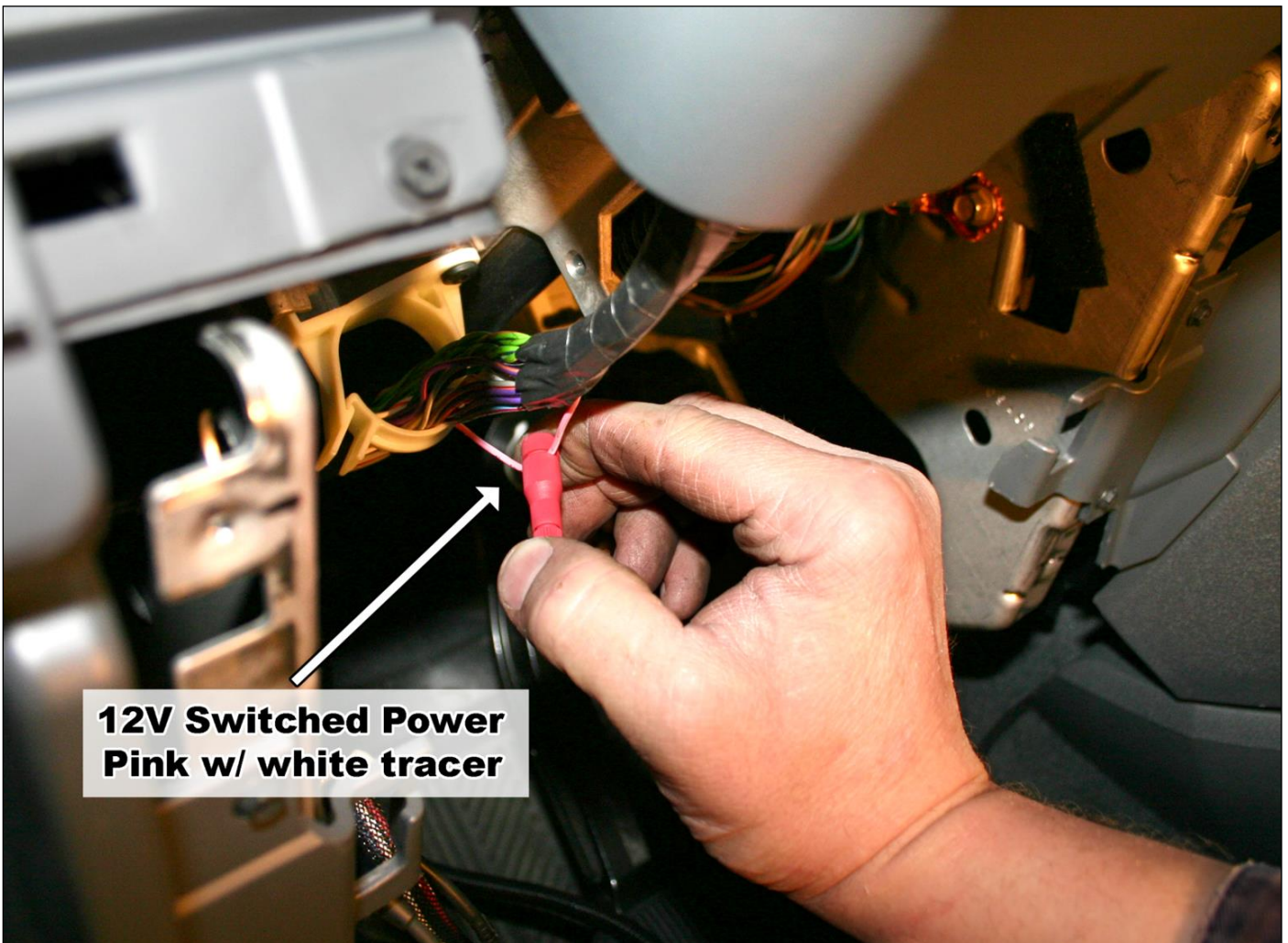

**12V Switched Power
Pink w/ white tracer**

Optional Manual Shifter Switch (Push-Pull Style)

Mount the shifter switch onto the shift lever using the clamp supplied (either 5/8" or 3/4").

Run the electrical cable down the shifter shaft, securing the cable with zip-ties or electrical tape, and run it under the carpet to the firewall and under the dash leaving enough slack for proper shifting of the transmission lever and to prevent any rubbing of wire.

At the end of the cable, cut off any excess and strip away about 1 to 2 inches of the black rubber covering exposing the black and white (or green) wires, and then strip the insulation from the ends of the two wires.



Connect the white (or green) wire to the Tan brake activation wire leading to the ECM. Connect the black wire to a nearby ground source. See page 17 for wiring diagram.

Optional Manual Shifter Switch (Rocker Switch Style)

Mount the shifter switch onto the shift lever using the clamp supplied (either 5/8" or 3/4"). Run the electrical cable down the shifter shaft, securing the cable with zip-ties or electrical tape, and run it under the carpet to the firewall and under the dash, leaving enough slack for proper shifting of the transmission lever and to prevent any rubbing of wire.

At the end of the cable, cut off any excess and strip away about 1-2" of the black rubber insulation exposing the black, white and green wires, then strip the insulation from the ends of the three wires.

Due to the characteristics of running the exhaust brake controls through the ECM, a relay kit has to be installed (unless you are installing the push-pull switch for the manual transmissions). This is so the light on the toggle switch (or rocker switch for the manual transmissions) can be lit while the exhaust brake is engaged. This relay comes pre-wired from the factory and is included in the main toggle switch kit.

Connect the tan wire coming from the ECM to terminal #87 on the relay. Connect the green wire leading from the switch to terminal #85 on the relay

Connect the green 12V output green wire to #85 on the relay, which then leads to the Tan brake activation wire going to the ECM.

Attach the 5/16" ring connector to the black ground wire and attach it to a good ground nearby.

Locate one of the ignition switched power fuses in the fuse panel underneath the steering column. Traditionally this wire will be pink with a white tracer. Use a voltmeter to check the voltage of the wire. Use the supplied fuse tap to supply ignition switched power to the "Keyed 12 Volts" (white) wire of the rocker switch assembly.

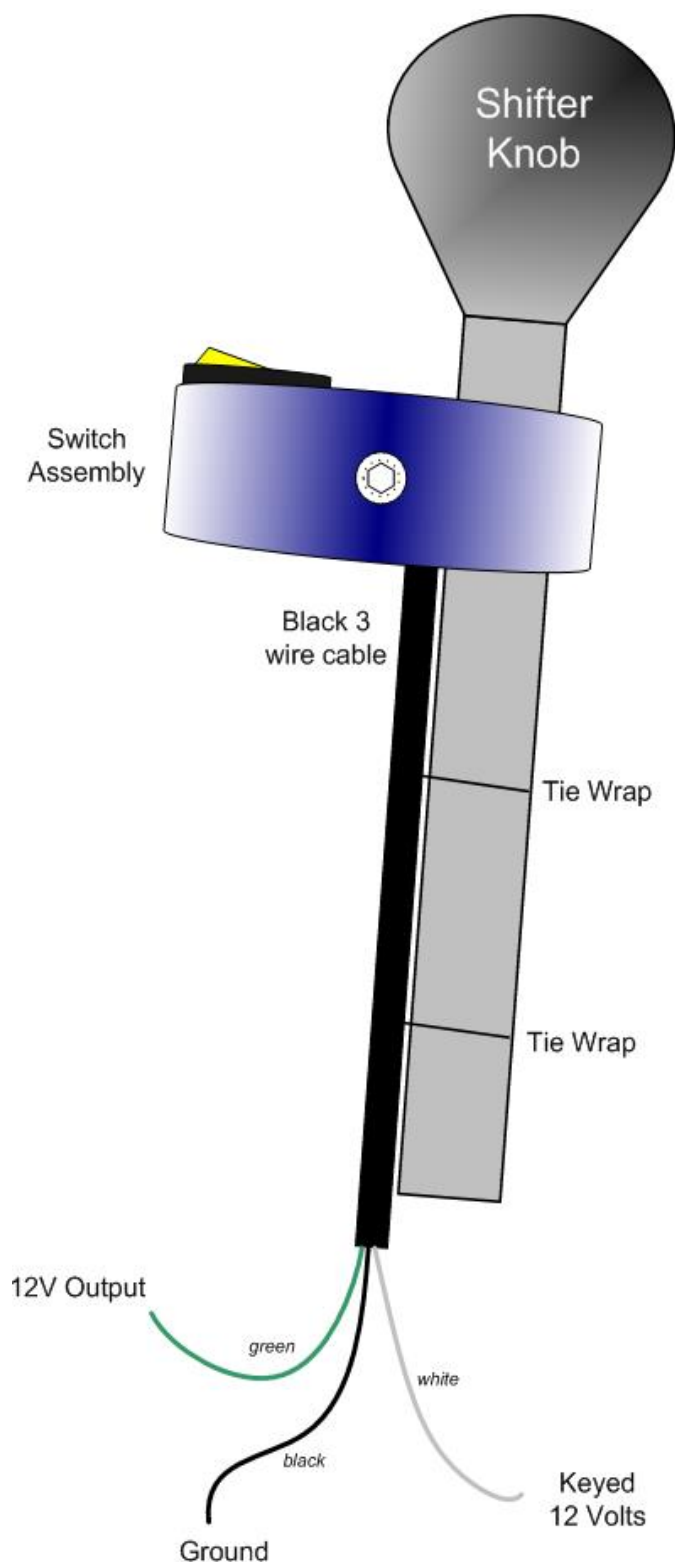

Attaching the switch relay

Due to the characteristics of running the exhaust brake controls through the ECM, a relay kit has to be installed (unless you are installing the push-pull switch for the manual transmissions). This is so the light on the toggle switch (or rocker switch for the manual transmissions) can be lit while the exhaust brake is engaged. This relay comes pre-wired from the factory and is included in the main toggle switch kit.

Connect the tan wire coming from the ECM to terminal #87 on the relay. Connect the green wire leading from the switch to terminal #85 on the relay. Connect the black Y-wire to a ground source nearby. Blade terminals have been included loose in the bag, but not pre-crimped, so you can strip the wire to the desired length.

Wiring With The Default Toggle Switch

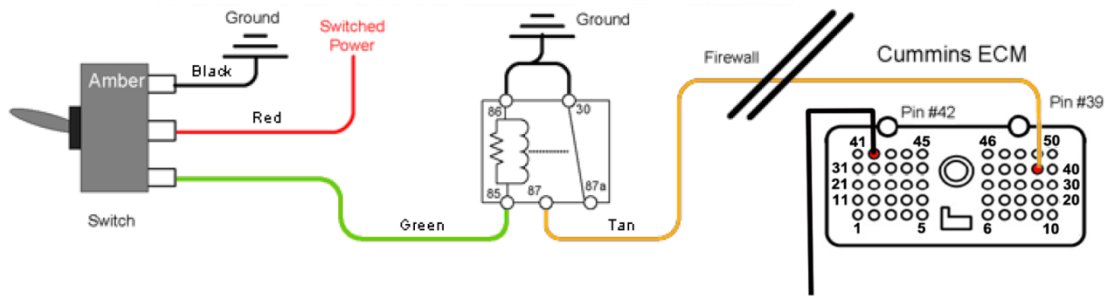

Wiring With The Rocker Switch (Manual Trans)

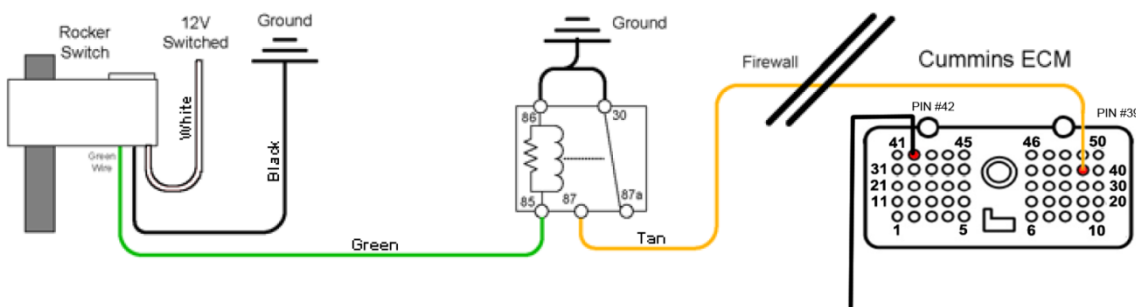

This switch relay is **not required** when wiring the exhaust brake with the push-pull style switch.

Wiring & Plumbing Diagrams

Using Main Toggle Switch Only

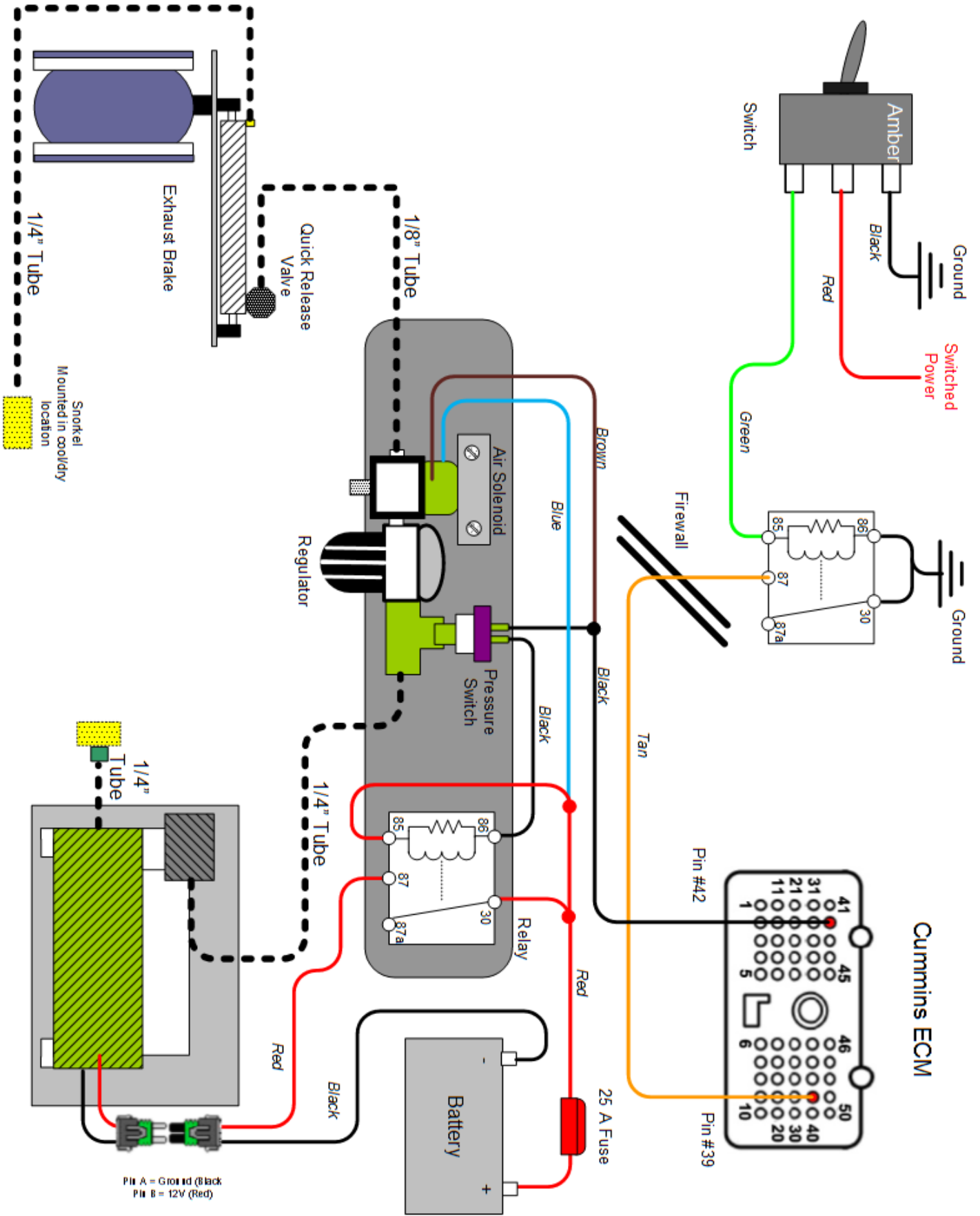

Using Push/Pull Shifter Switch (Manual Trans)

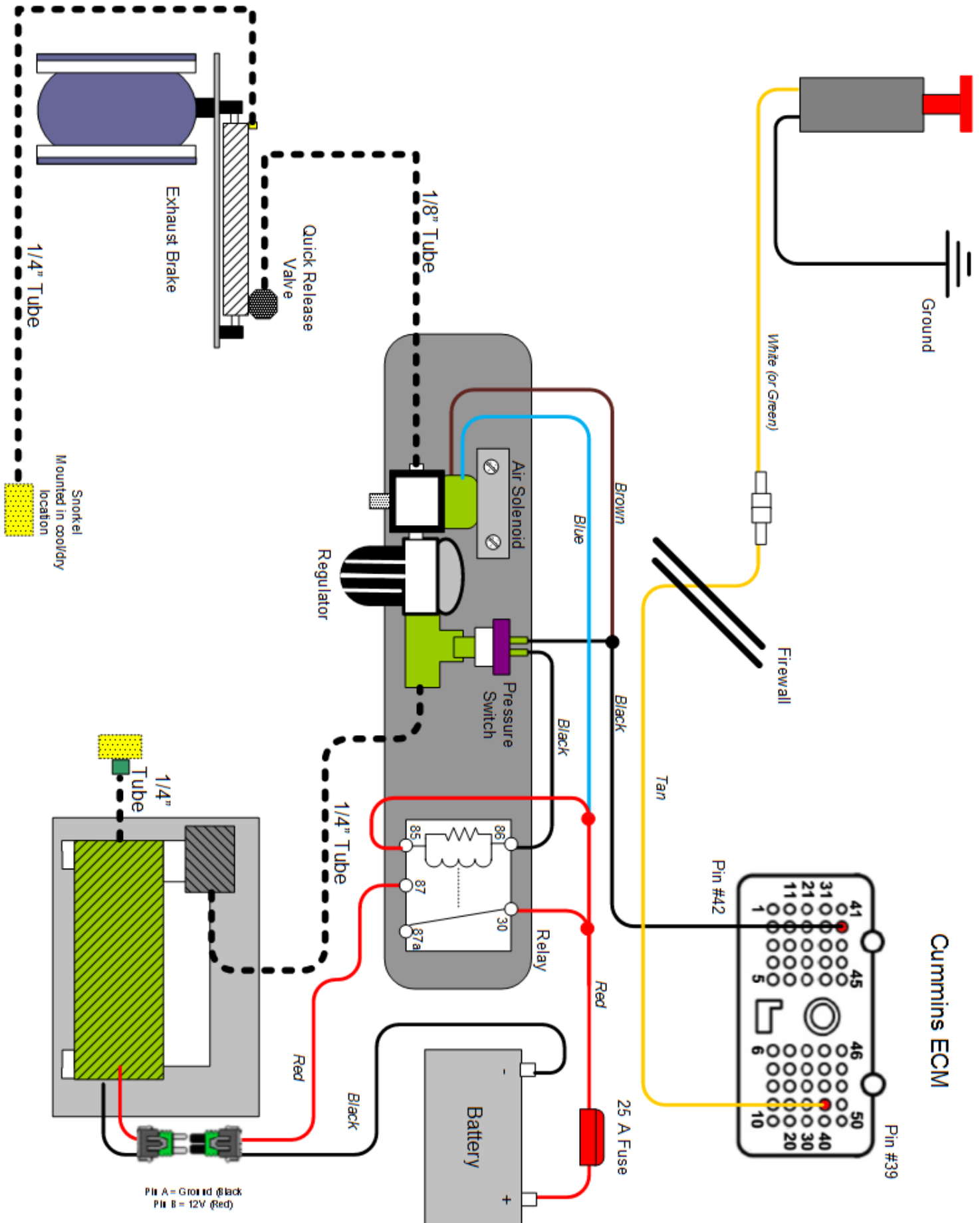

Using Rocker Switch (Manual Trans)

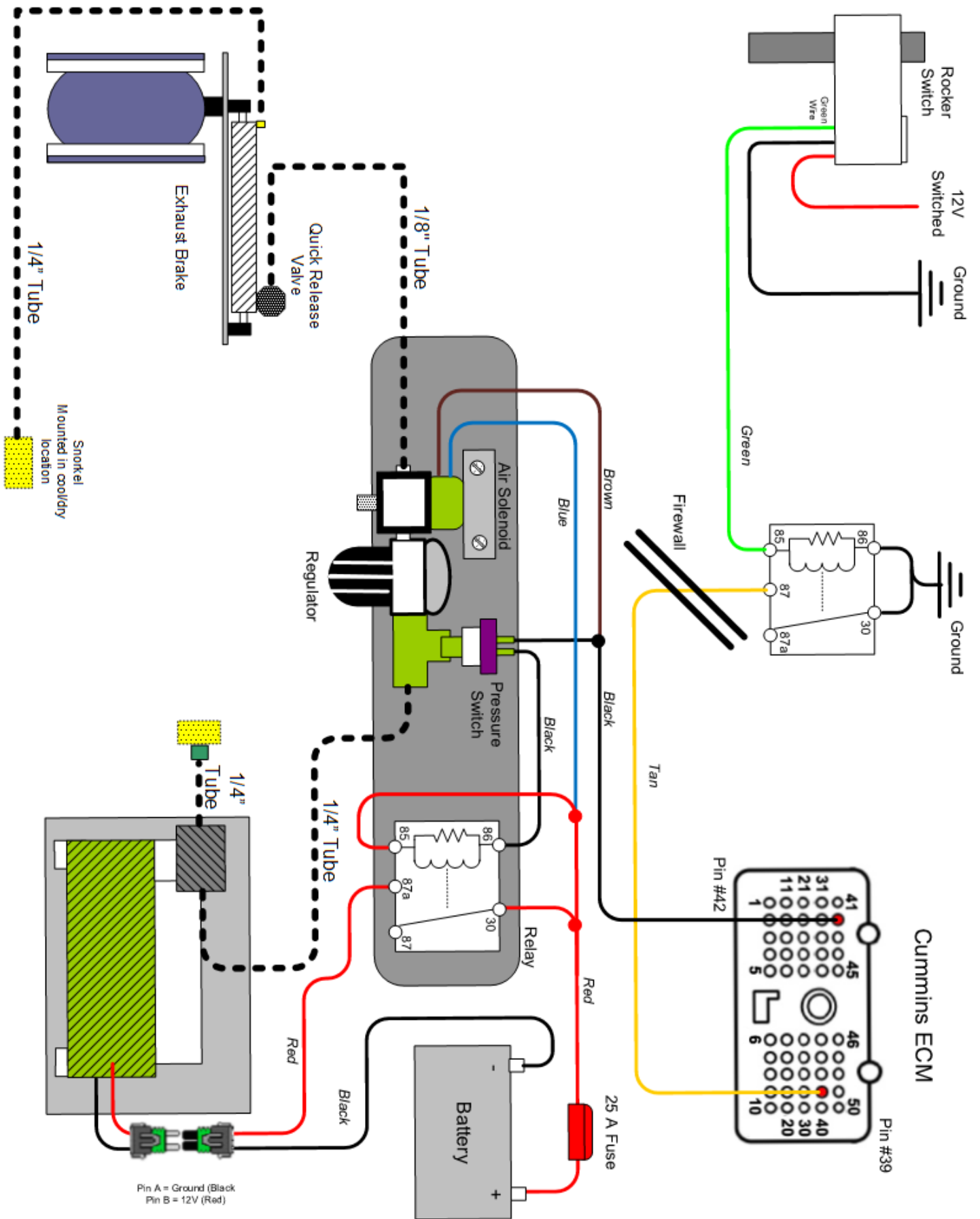

Exhaust Back Pressure Testing for Air Actuated Brakes

To test exhaust brake system pressure, a minimum 0-100psi pressure gauge is required.

We recommend purchase of a BD brake pressure gauge kit #1030050.

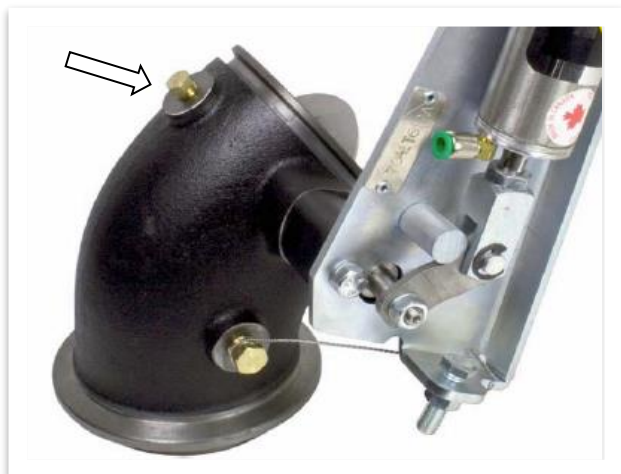

You do not need to measure the air pressure in the system, just the exhaust backpressure, which is located on the cast valve.

Idle Pressure Test

With the BD brake engaged and the engine at idle check the exhaust backpressure using a pressure gauge (such as BD PN 1030050) at the test port on the brake valve.

If the back pressure is below 13 psi at idle you have a number of likely causes. The most common being an exhaust leak either at the clamp joint or at the welds (only on some models). Apply the exhaust brake and have someone assist you looking for soot trails or the visible leak. Another culprit would be an exhaust manifold leak, turbocharger gasket leak, turbocharger problem or an EGR issue.

If the back pressure is greater than 25psi, you will need to make an adjustment on the stop bolt. Loosen the jam nut, and lengthen the stop bolt towards the actuator, this will shorten the stroke distance. Only turn 1/4 rotation at a time and re-secure the jam nut. Retest idle pressure.

NOTE: The brake stop-bolt and regulator have been preset at the factory and should not need to be adjusted.

We generally do not recommend adjusting the stop bolt, please consult BD before doing this as it may void your warranty.

Off-Idle Pressure Test & Adjustment

Your BD exhaust brake is a variable-orifice design so when the brake is active and the engine is at higher RPM the brake lever does not rest on the stop bolt. Off-idle backpressure is set by adjusting the air pressure regulator which will in turn increase or decrease off-idle exhaust backpressure. You will need to secure your pressure gauge somewhere that you can see it while you are driving. Using a long extension hose & bringing the gauge into the cab through an open window or clipping it under a windshield wiper works well.

Get the truck up to speed (a downhill grade or a load in the truck is helpful) and activate the exhaust brake. Note the maximum backpressure achieved. You should get peak backpressure at higher RPM (try 3000 RPM in Drive). If you cannot reach the desired backpressure (compare table below) you can begin troubleshooting, the first step is to look for exhaust leaks either from the clamps, exhaust manifolds or feed pipes. Also look for leaks at the clamps located at the back of the turbo and also at the down pipe. If all connections are sealed, you can then use the adjusting regulator to increase the backpressure. Note that small regulator adjustments can have a significant effect on off-idle backpressure.

Turning the regulator **clockwise** will increase pressure.

Turning the regulator **counter clockwise** will decrease pressure.



NOTE: Over the next two weeks, the backpressure at idle may rise due to initial carbon build up on the inside of the brake housing and on the butterfly. The stop bolt may need to be adjusted again to compensate.

Application	Maximum Back Pressure
GM/Chevy 6.5	35 psi
GM/Chevy Duramax	55 psi
Ford Powerstroke	45 psi
Dodge Cummins 1988-98 12V w/o 60lbs Springs	40 psi
Dodge Cummins 1988-98 12V with 60lbs Springs	60 psi
Dodge Cummins 1998 to current	65 psi

*HD Spring part# is 1030060.

CAUTION: Do NOT exceed the maximum back pressure value in the exhaust system. Exceeding this pressure will force the exhaust valves open during the intake stroke which could cause engine damage.

Maintenance

To extend life of the exhaust brake, do not operate the vehicle for extended periods of time without activating the brake. We suggest activating the exhaust brake at least a couple times a day while operating the vehicle to prevent any carbon or rust build up on inner parts of the brake valve assembly.

The hoses, wires, fittings and clamps should be inspected on a regular basis for any deterioration, damage or leaks.

To increase the life of your exhaust brake, we recommend daily operation. By simply switching the brake on and off a couple times a day, it will prevent the butterfly valve from sticking due to carbon build-up.

Air Brake Troubleshooting Guide

This guide assumes that your exhaust brake system is using a DFIV and a BD air compressor. If your system uses a microswitch for throttle activation, the operation of the air solenoid and pump are the same as with the DFIV. If you are using existing on-board air, check that system as appropriate.

When I let off the throttle nothing happens.	<u>No</u>	<u>Yes</u>
Is the DFIV powering its "brake" output when the throttle is at idle and brake switch and ignition are both on?	<p>Check if DFIV has good power, ground and throttle signal. Check DFIV adjustment. If these things check out, but the DFIV won't power the "brake" output, the DFIV is likely faulty.</p> <p>Also check power & ground at pump relay and make sure the air solenoid has a good ground.</p>	<p>Check that when air solenoid is powered it will allow air to flow from the #2 port out the #1 port.</p> <p>Check that pump relay is powering pump. If pump has power but does not run, pump is likely faulty. Check for power & ground at pump relay, if these are good but relay does not click or does not power pump, relay is likely faulty.</p>
The brake comes on but there's little or no holdback	<u>No</u>	<u>Yes</u>
<p>See if torque converter is staying locked up during deceleration. If not, the engine RPM will fall to idle when the throttle is released. The brake will be ineffective without the torque converter locked up.</p> <p>Check off idle brake pressure. (See back pressure chart) Are you getting maximum allowable backpressure?</p>	<p>Check for exhaust leaks. A small leak can result in a significant decrease in back pressure. If no leaks are found try adjusting air regulator. Check for air leaks in brake system.</p>	<p>Try down shifting more aggressively. More RPM will give more holdback. Transmission or torque converter could be slipping internally.</p>
Everything seems to work, but the brake valve won't close.	<u>No</u>	<u>Yes</u>
Check that air is reaching brake air cylinder?	Air solenoid or quick release valve are likely stuck, plugged or faulty. Clean or replace as required.	Cylinder or brake valve are seized. Remove the clevis pin on the end of the cylinder rod & see if the valve lever can be moved freely.
The valve lever can be moved freely?	Try dismounting the brake & cleaning the carbon out of it. If this does not work the brake valve will need to be replaced.	The cylinder is stuck and will need to be replaced.
Problem	Solution	
Air compressor runs in short bursts and brake is slow to apply.	There is a restriction in the air system, normally in the regulator or air solenoid. Remove the fittings from the regulator and air solenoid, you will likely find some corrosion or debris caught in them. Clean this out with a pick, small brush, compressed air and WD40 or similar lubricant.	
Air compressor runs continually.	Pump relay is likely stuck on. Check operation of relay & replace as required.	
Brake is slow to release.	Debris or corrosion is restricting the quick release valve or air solenoid. Clean as required. Air solenoid could be too far from brake.	