

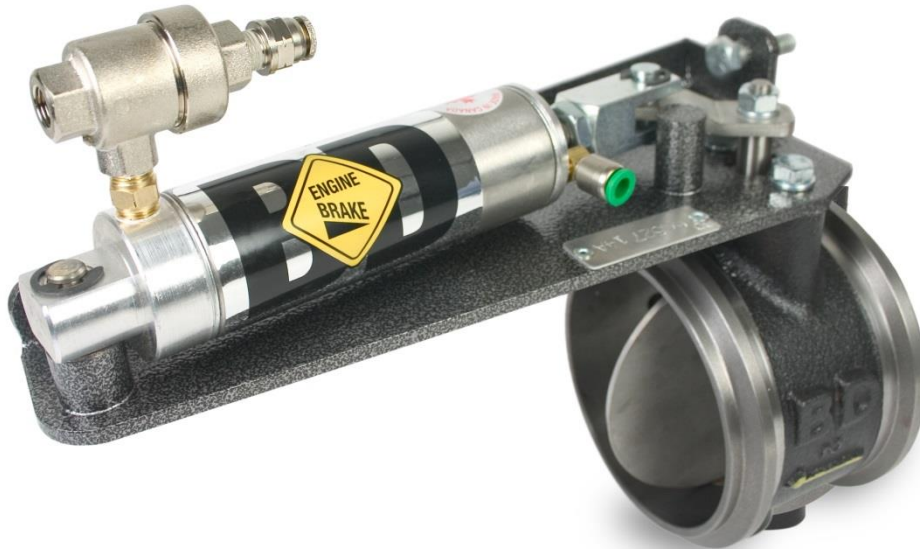

INSTALL MANUAL



BD Remote Mount Exhaust Brake 1999-2003 Ford 7.3L Powerstroke

P/N	Application
1027144	Ford 7.3L Air Exhaust Brake 99-03 4.0" Exhaust

***** Please read this manual before starting installation. *****

OWNER'S MANUAL - LEAVE IN GLOVE BOX

The brake pressure at idle must be checked and adjusted at time of install, at least two weeks after install, and at regular twice a year intervals.

Table of Contents



Introduction	2
Kit Contents	3
Optional Accessories	4
Notes on Connectors	4
Tools Required	5
Installation	5
Brake Valve Installation	5
Air Hose Installation	6
Vacuum Pump & Reservoir Removal.....	7
Air Compressor.....	8
Regulator Installation	9
Pump Relay Harness and Under-hood Plumbing.....	9
<i>DFIV Control Module Installation</i>	11
Main Switch Install	13
Optional Shifter Switch Installation (Manual Transmissions)	14
Push-Pull Style	14
Rocker Switch Style	15
Exhaust Brake Wiring	16
DFIV Calibration	17
Maintenance	17
Exhaust Back Pressure Testing Air Actuated Brakes	18
Air Brake Troubleshooting Guide	20

Introduction





Thank you for purchasing a BD Diesel Performance Engine Exhaust Brake. This manual is divided into different areas to assist you with the installation and operation of your braking unit. We strongly suggest that you write down the kit and serial numbers of your unit in the spaces provided and retain this manual for any future reference.

Kit Contents





Please check to make sure that you have received all parts for your kit

1127038-A	1030125-C	1220113-A
		
<i>Valve Assembly</i>	<i>Air Pump Kit</i>	<i>Air Tubing Assembly</i>
Qty: 1	Qty: 1	Qty: 1

1220145-D	1321039	1030124
		
<i>Regulator/Control Assy.</i>	<i>DFIV Install Kit</i>	<i>Vacuum Pump Relocation Kit</i>
Qty: 1	Qty: 1	Qty: 1

1100404	1220410	1100400	1100740
			
<i>4" Marmon Clamp</i>	<i>1/4" Air Tubing</i>	<i>4" Pipe Adapter</i>	<i>4" S/S Exhaust Clamp</i>
Qty: 2	Qty: 5ft	Qty: 2	Qty: 1

Optional Accessories

1300210	1030900
	
Push/Pull Switch Kit	Rocker Switch Kit
1030223	1081160
	
BD Torque Convertor	Cool Down Timer 2

Notes on Connectors

The kit includes a number of Posi-Tap™ connectors (Gray or Red/Black/Green or Yellow) to tap onto OEM wiring. It is important to select the correct color of connector so that it matches the gauge of the OEM wire that it is being installed on. Using the incorrect connector could cause an inadequate connection and/or the OEM wire could be severed.

OEM Wire	Posi-Tap™ Color
18-22ga	Gray or Red
12-18ga	Black
10-12ga	Green or Yellow

Though these connectors offer a quicker installation, the best option would be to solder the wires and isolate the joints with heat shrink or liquid electrical tape. Proper soldering techniques should be used to ensure adequate connections.

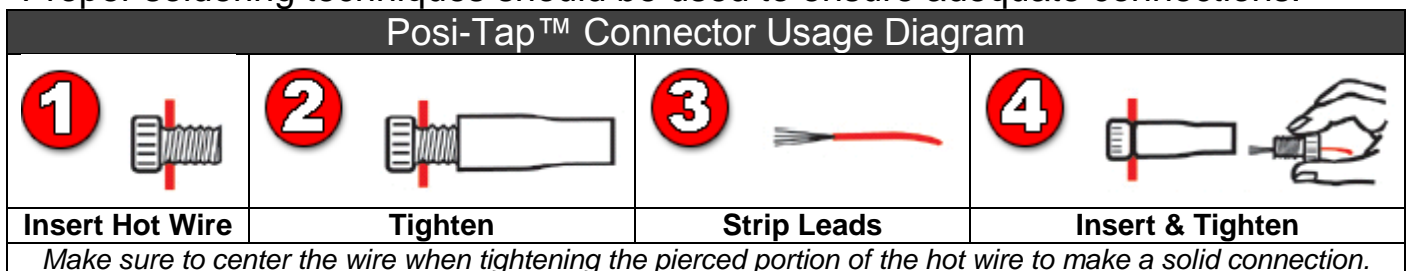

The ground terminals of the vehicle's batteries should be disconnected before performing any piercing/posi-tapping onto any ECM/PCM wire.

Tools Required

- Measuring tape or ruler
- Reciprocating saw or hacksaw
- Wire Crimping Pliers
- Drill with 1/8", 3/16" bits and Uni-bit
- Small bladed flat tip screwdriver
- Socket Set
- Welder
- Heat gun or lighter
- Test light

Installation

To prevent damage to electronic components, it is recommended that both battery negative terminals be disconnected while working on the vehicle.

Please read this manual thoroughly before installing this exhaust brake.



Raise and support the vehicle with a vehicle hoist or with appropriate jack stands.

Ensure vehicle is safely supported before proceeding to reduce possibility of damage or injury.

Brake Valve Installation

Note: This kit is for a 4" exhaust, 3.0" or 3.5" adaptors available separately.

Locate the catalytic converter. About 8" from the rear of the catalytic converter you will need to remove a 7 1/4" section of the exhaust.

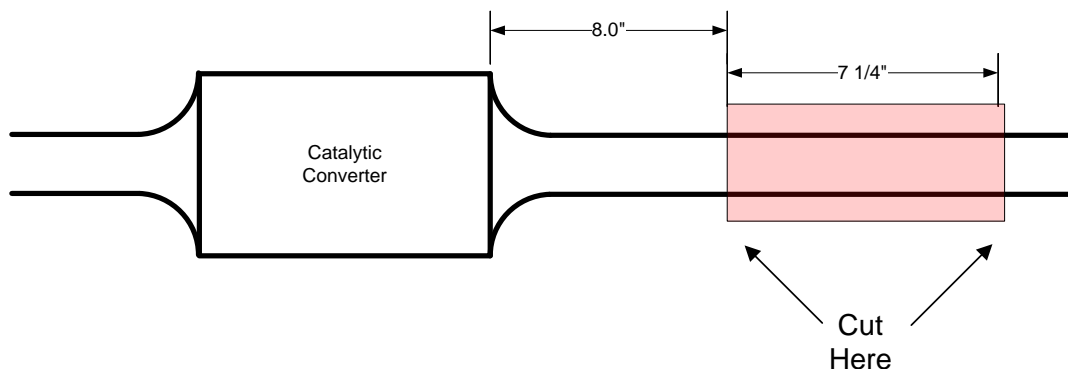

Remove any burrs from the ends of the cut pipes. Slide the supplied pipe adapters over each end of the cut pipes. Weld the adapter closest to the front of the vehicle in place. A good clean weld is needed to seal the high backpressure that the exhaust brake will create. The rear adapter will be secured with the supplied stainless band clamp.

Insert the valve assembly in between the two adapters. Note that there is an arrow cast into the exhaust brake, this should point towards the rear of the vehicle. Secure the brake to the front adapter using the supplied v-band clamp. Slide the rear adapter up to the brake and secure it with the other v-band clamp. Secure the rear adapter to the exhaust pipe with the supplied band clamp.

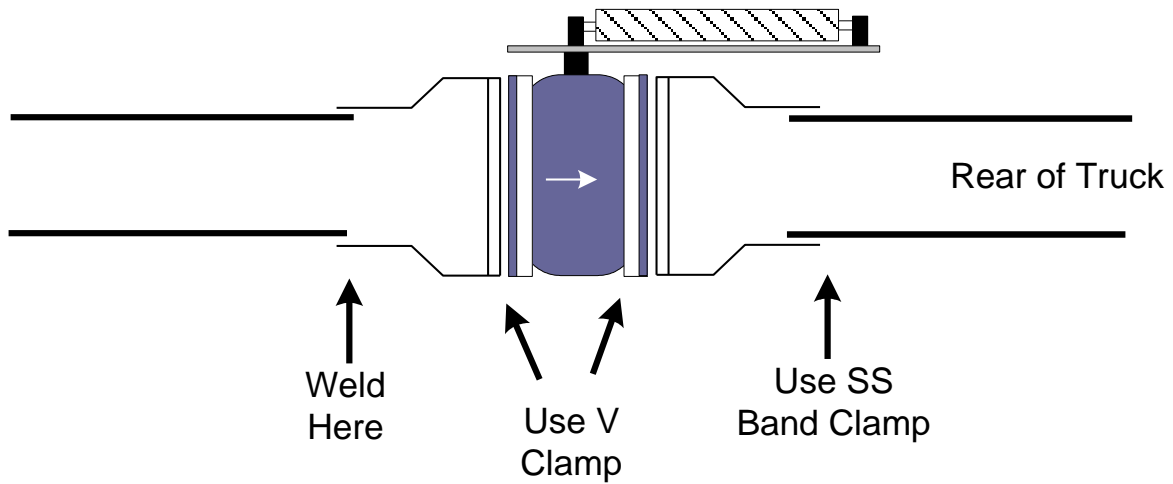

IMPORTANT The front exhaust connection **MUST** be welded. Using a band clamp or conventional exhaust clamp on this joint will cause leaks and will not retain full exhaust brake pressures.

Air Hose Installation

This kit is supplied with a premade air tubing assembly. The 1/8" air tube is the pressurized air feed to the brake pneumatic cylinder and the 1/4" air tube is the vent line for the cylinder.



Insert the 1/8" air tube into the quick connect fitting on the quick release valve on the air cylinder.

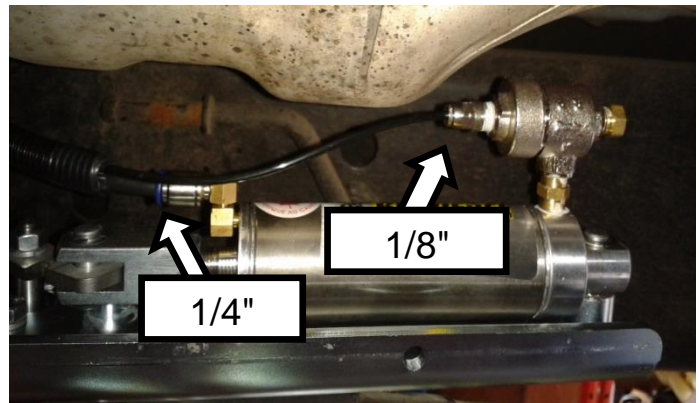

Insert the 1/4" tube into the vent-side quick connect fitting.

Feed the air tubing assembly over the top of the frame rail and support it so that there is no stress on the air tubes where they enter the brake valve. Route the air tubing assembly along the frame rail and secure with wire ties to the existing wiring harness.



Route the other end of the assembly into the engine bay up the passenger side of the firewall. It will be connected later.

Vacuum Pump & Reservoir Removal

Locate the small electric vacuum pump and reservoir on the passenger side fender well. Remove the reservoir by removing the bolts attaching it to the fender, disconnecting the electrical connector and removing the air hose.

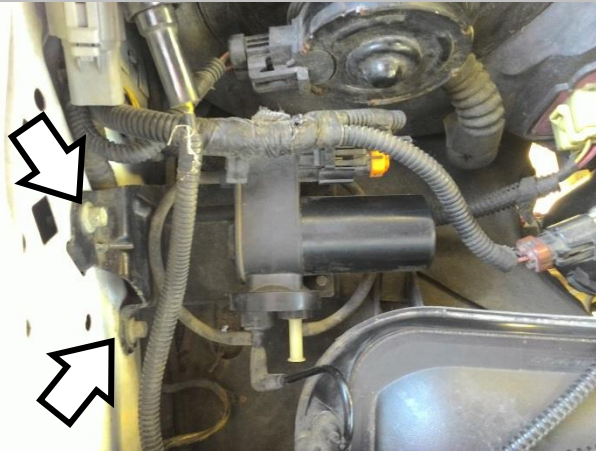

Remove the small electric vacuum pump from the stock bracket by removing the small screws. Reinstall on to the supplied relocation bracket. Trim the rubber ends on the three vibration dampers to clear when reinstalling. Install on the passenger side of the radiator support bracket with the two bolts and washers provided.

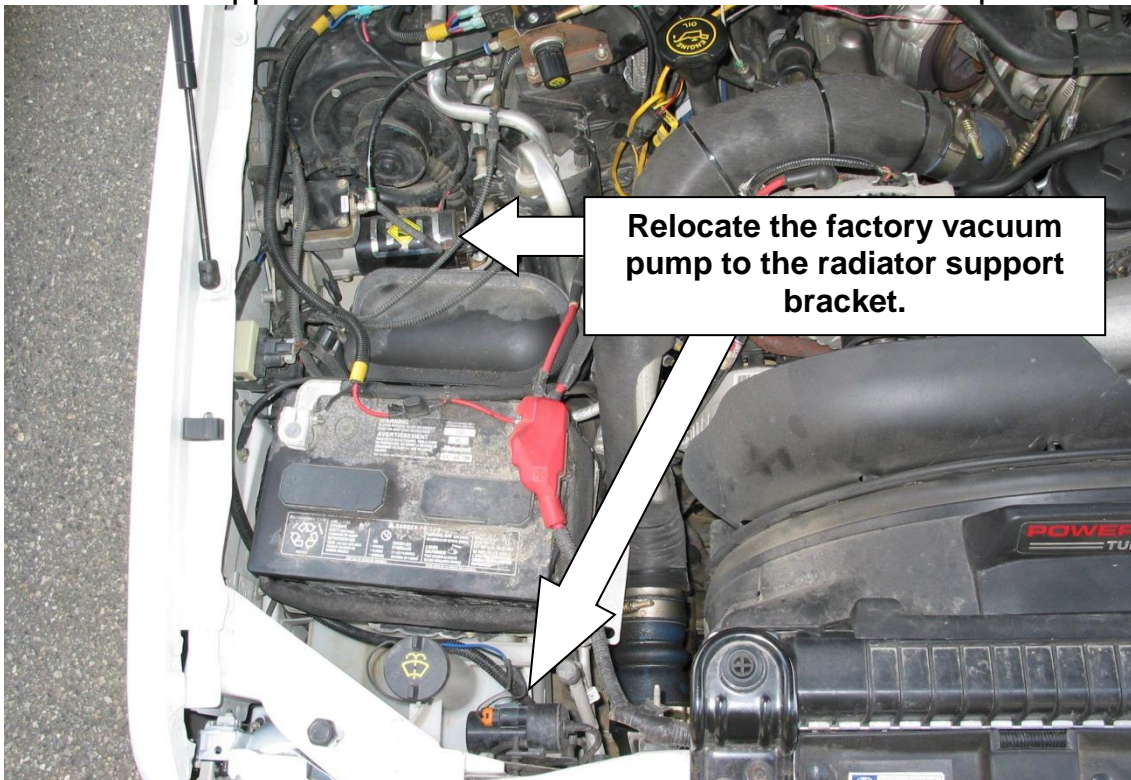

Cut the power supply wires for the electric vacuum pump approximately 4" from the connector and splice in the black and blue wires supplied using the butt connectors and shrink tubing. Route the relocation loom along the fender and towards the front up to the new vacuum pump location. Inside of the loom should be the supplied black and blue wires, along with the 1/8" plastic vacuum tube. Shrink tubing has been provided to securely seal these connections.

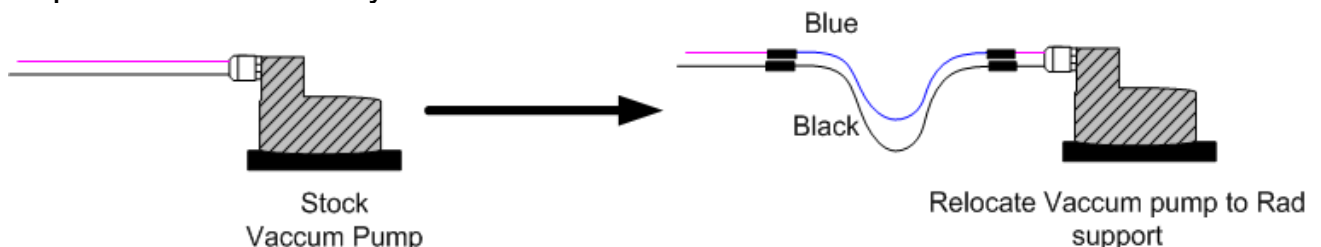

Air Compressor

The air compressor will mount in the location that the vacuum pump previously occupied.



To install the BD compressor, first remove the two 11mm nuts securing the vacuum reservoir to the fender. These are accessed from in the wheel well below the reservoir.



Once the vacuum reservoir is loose, slide the air compressor bracket under the rear mounting stud for the reservoir.

Note Disconnecting the AC pressure switch electrical connector and moving the harness out of the way temporarily will make this process easier.

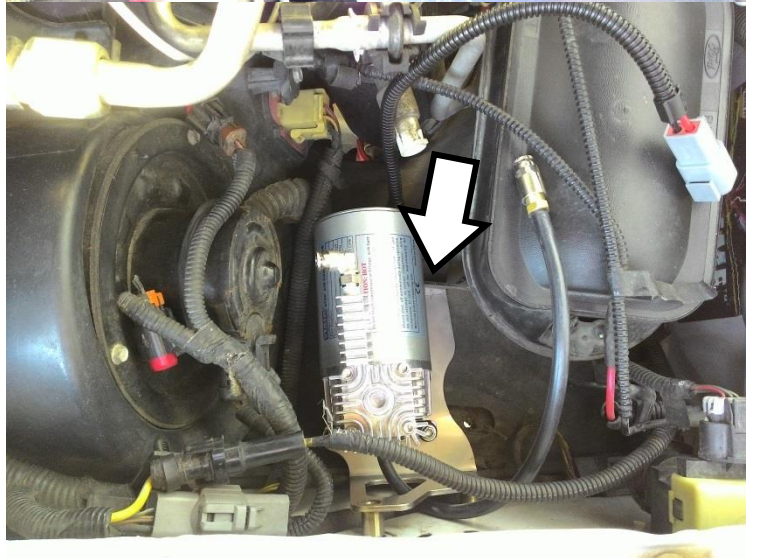

Install the supplied bolts and lock washers to attach the pump bracket to the fender where the vacuum pump previously attached. Reinstall the two 11mm nuts holding the vacuum reservoir.

Regulator Installation

The air regulator/control assembly will be mounted to the top of the air conditioning assembly near the firewall. Remove the two front 10mm nuts securing the MAP sensor bracket and remove the 8mm screw from the top of the housing.

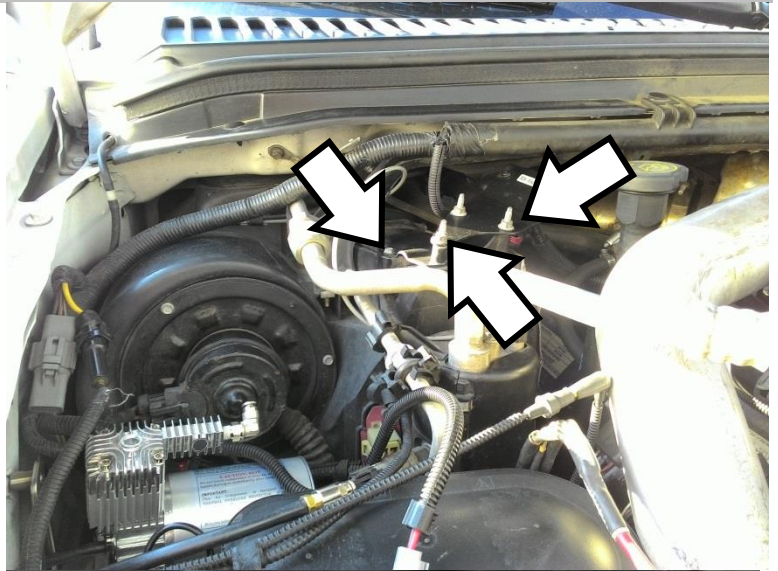

Remove the relay from the relay socket in the supplied wiring harness. Install the relay socket using the small screw in the top of the air conditioner housing and reinstall the 8mm screw. Then install the bracket on the top of the two studs and refasten the 10mm nuts.

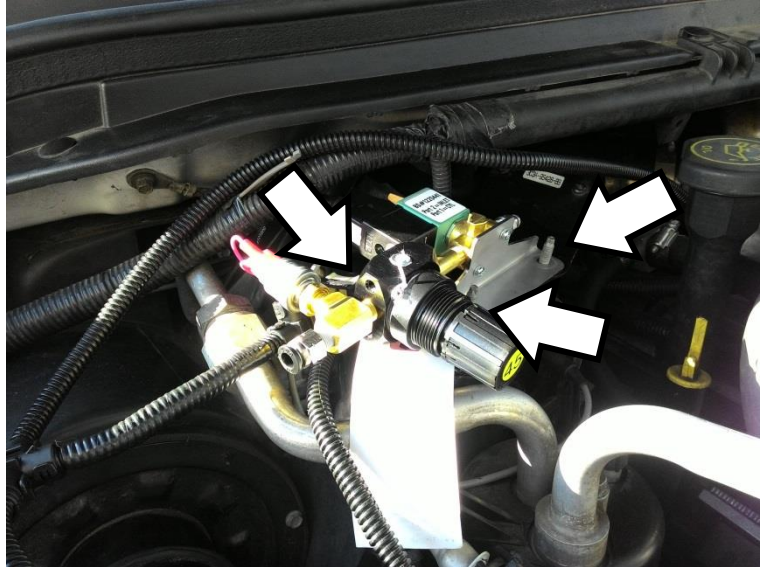

Pump Relay Harness and Under-hood Plumbing

Starting with the relay harness assembly, connect the female 2 pin connector from the relay harness to the male 2 pin connector on the BD Air compressor.

Route and connect the ground eyelet (black wire) to a bolt on the firewall that will provide a good ground.

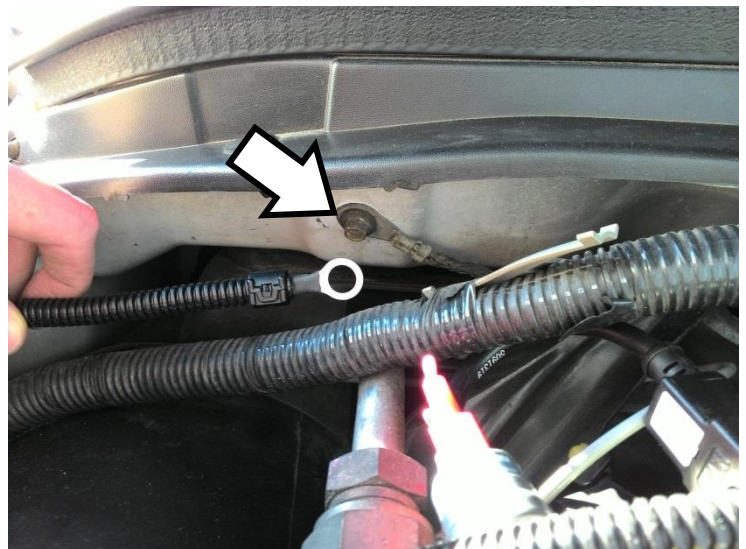

Connect the ring terminal on the red wire to the passenger side positive battery terminal (The negative battery leads should not yet be connected at this time).



Connect the air compressor to the air pressure regulator using a piece of the supplied 1/4" air tube. Cut to approximately 7.5"L. This goes from the outlet of the pump to the inlet of the regulator.

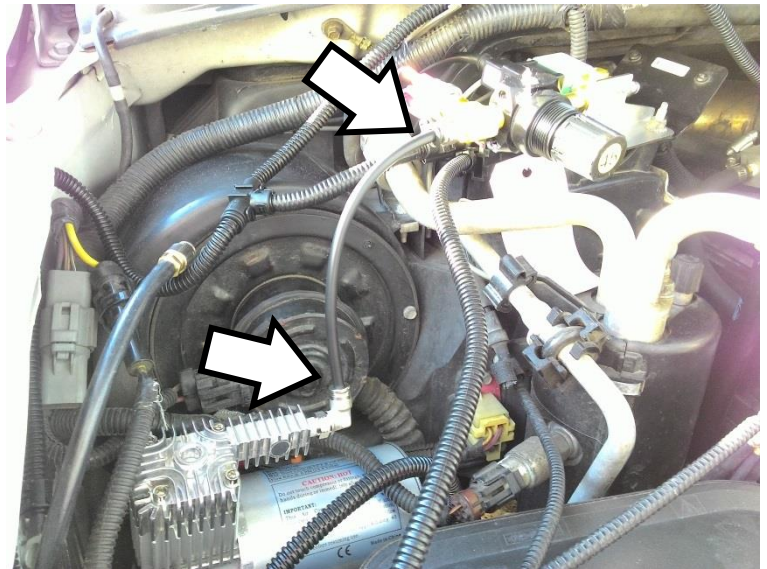

Install the intake air filter for the air compressor by adding a length of 1/4" air tubing to the rubber hose section. Then route this 1/4" line to a dry location (behind the regulator assembly is suggested). Install the "pancake" style filter supplied with the pump to the end of this tube.

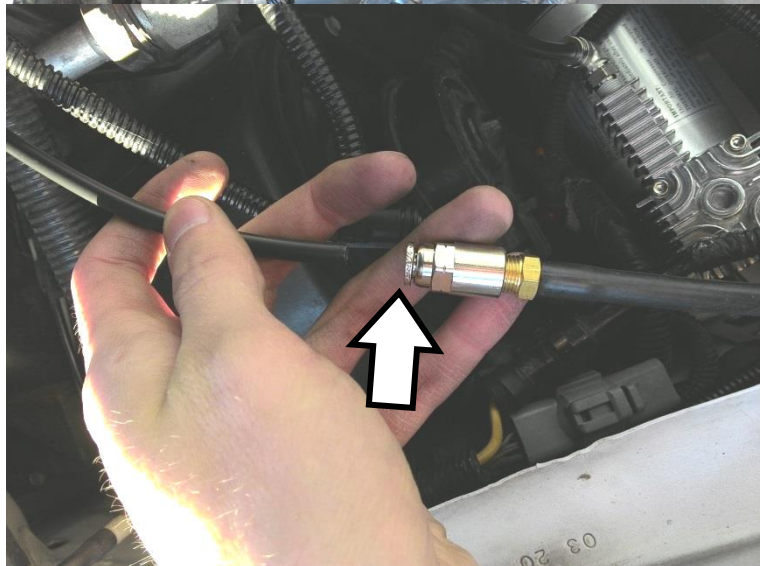

Locate the air tubing assembly previously installed on the brake valve air cylinder. Trim if necessary and install the 1/8" tube onto the outlet of the air solenoid. The other 1/4" line in this assembly is a vent for the air cylinder and may be installed in the same location as the air compressor inlet air filter.

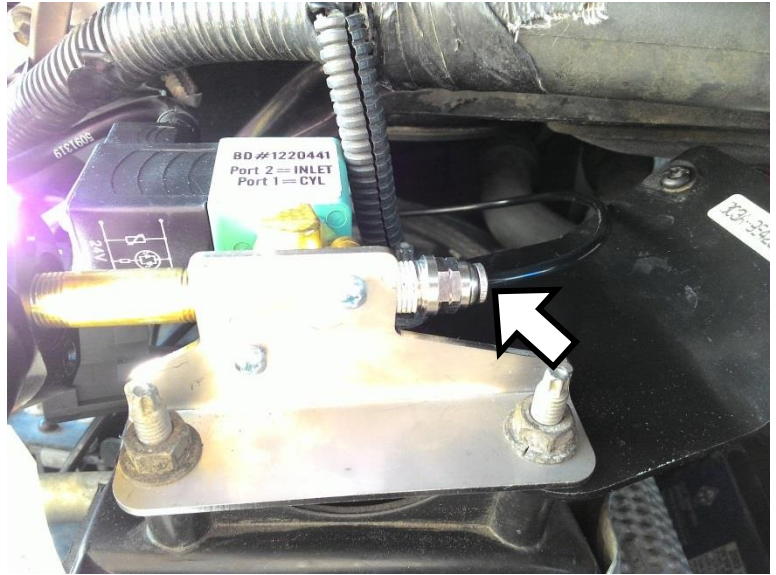

DFIV Control Module Installation

Route the Green, Blue and Pink wires from the DFIV through the firewall (If the vehicle does not have cruise control, you can remove the Green and Blue wires from the DFIV and discard them). Connect the Pink wire to the corresponding Pink wire on the Air Solenoid and Regulator assembly using one of the provided crimp connectors with the clear heat shrink.

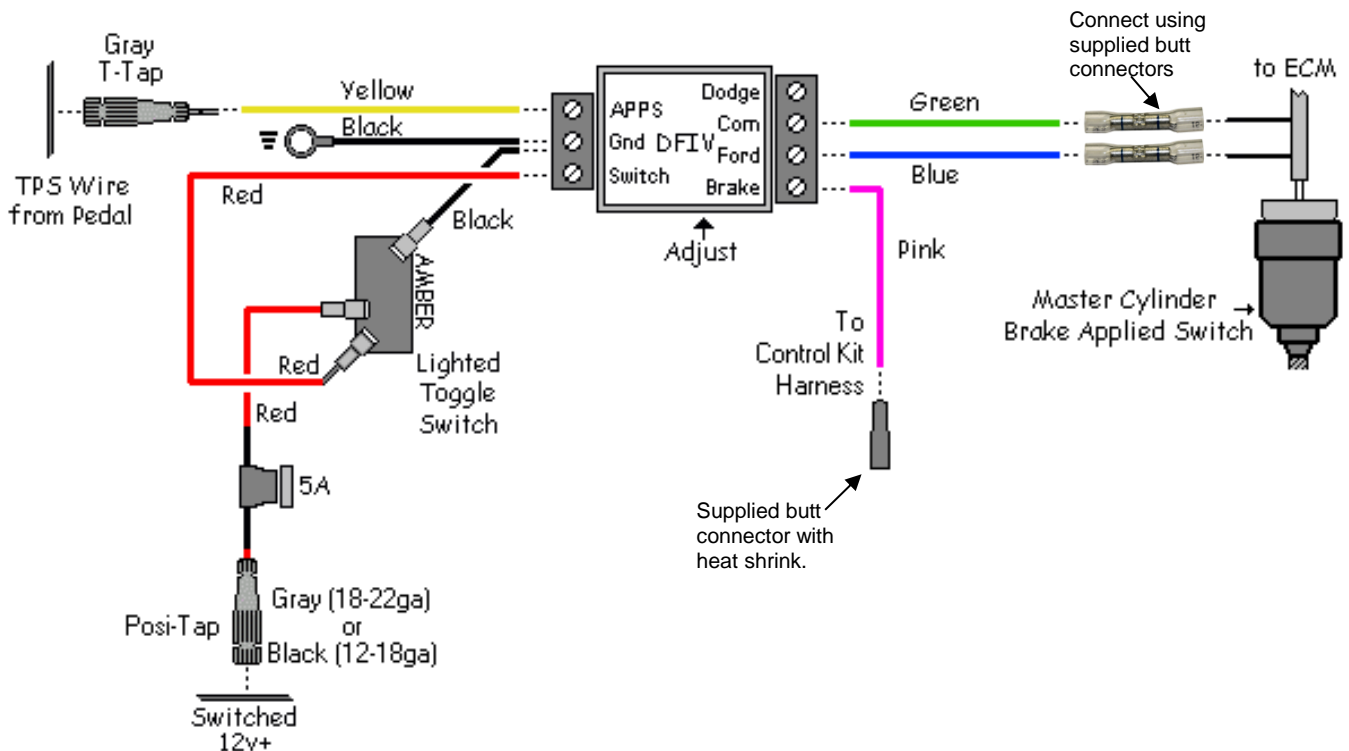

Remove lower section of dash, under the steering column, and mount the DFIV module to the cross member under the steering column. Connect the Black wire from the DFIV module to a good ground.

Locate the Throttle Position Sensor at the throttle pedal and, using a red Posi-Tap connector, attach the Yellow wire from the DFIV module to the Grey wire w/White tracer on the TPS.

Locate the Black w/Yellow wire at the Cruise Control Disable (Brake Applied) switch located on the brake master cylinder and expose the wiring approximately 4 to 6 inches from the switch to allow for a good length to work with.

NOTE: This wire may be a different color in various applications. If there is no Black w/Yellow wire going to this switch, use a test light to check which wire changes state (power to no power) when the brake pedal is applied.

Cut the black wire w/yellow tracer (BK/YL), and attach the blue Posi-Lock connectors to both sides of the cut wire.

Run the green and blue supplied wires that were brought through the firewall to the Brake Applied Switch at the brake booster and trim to fit. Now connect the blue and green wires to Posi-Lock connectors that were installed earlier to the Black w/yellow wires. It does not matter which orientation the wires are connected.

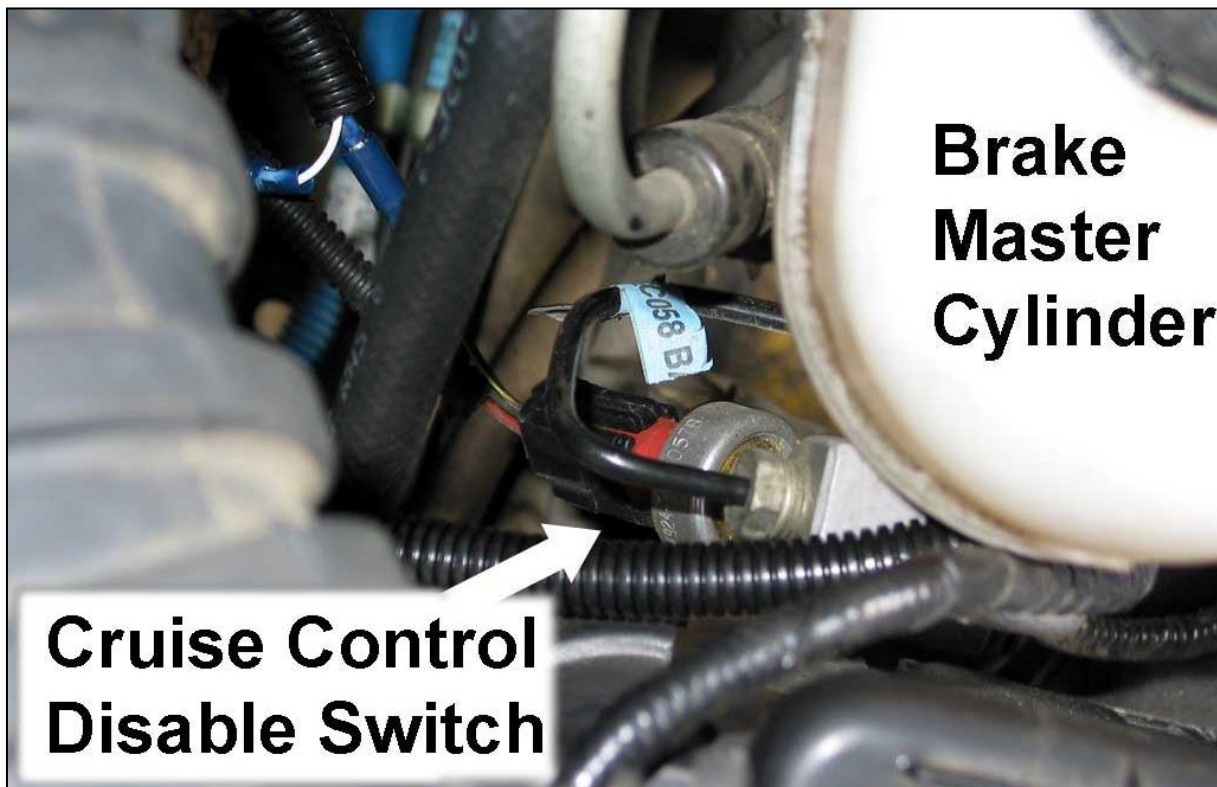

Main Switch Install

If you are installing an optional shifter-mounted switch with a manual transmission you can skip installing the toggle switch and proceed to page 14 or 15 for instructions on installing the shifter switches.

To use the toggle switch you will need to choose a location in the dash that has room in behind for the switch body. Drill a 1/8" pilot hole and then use a unibit to drill the hole out to 1/2" and mount the switch.

Locate one of the ignition switched Red/Black tracer wires under the steering column (one is 10/12ga and the other is 14/16ga) and connect an appropriate Posi-Tap to it (yellow for 10/12ga, black for 14/16ga, red for 18/20ga). Connect the toggle switches red wire with the build-in fuse holder to this Posi-Tap. Connect the other red wire from the toggle switch to the "Switch" terminal on the DFIV. Connect the black ground wire on the toggle switch to the Gnd connection on the DFIV.

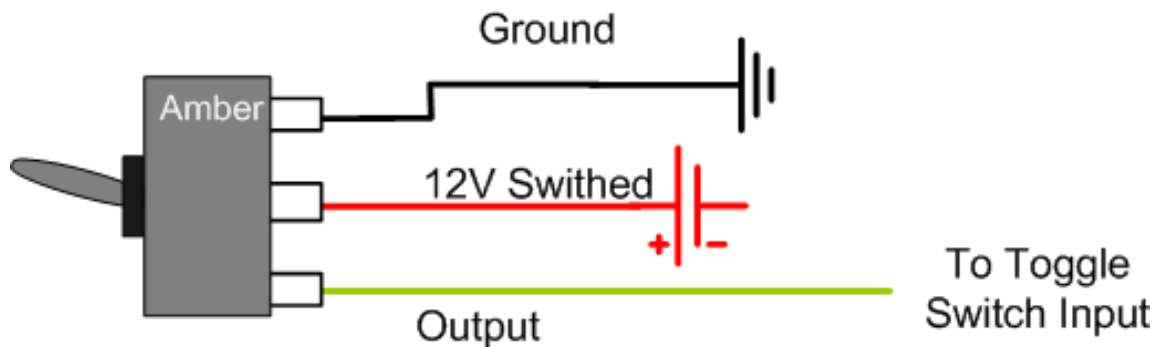

Once the switch is installed you can reconnect the positive terminals on both batteries then reconnect the negative terminals. Reinstall driver's side battery cover.

Optional Shifter Switch Installation (Manual Transmissions)

Push-Pull Style

Mount the shifter switch onto the shift lever using the clamp supplied (either 5/8" or 3/4"). Run the electrical cable down the shifter shaft, securing the cable with zip-ties or electrical tape, and run it under the carpet to the firewall and under the dash to the control module, leaving enough slack for proper shifting of the transmission lever and to prevent any rubbing of wire.

At the end of the cable, cut off any excess and strip away about 1 to 2 inches of the black rubber covering exposing the Black and White (or Green) wires then strip the insulation from the ends of the two wires.

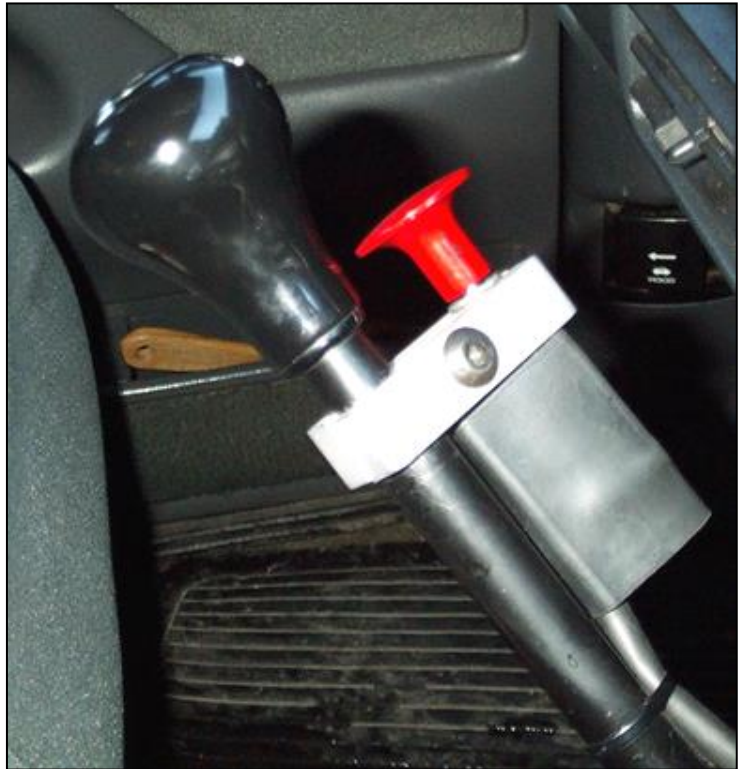

Connect the White (or Green) wire to the "Toggle Switch" terminal on the control Module.

Connect the black wire to the "12 volt switched" input on the control module.

Once the switch is installed you can reconnect the positive terminals on both batteries then reconnect the negative terminals. Reinstall driver's side battery cover.

Rocker Switch Style

Mount the shifter switch onto the shift lever using the clamp supplied (either 5/8" or 3/4"). Run the electrical cable down the shifter shaft, securing the cable with zip-ties or electrical tape, and run it under the carpet to the firewall and under the dash to the control module, leaving enough slack for proper shifting of the transmission lever and to prevent any rubbing of wire.

At the end of the cable, cut off any excess and strip away about 1-2" of the black rubber insulation exposing the black, white and green wires, then strip the insulation from the ends of the three wires.

Connect the green 12V output wire to the "Toggle Switch" input terminal on the control module.

Attach the 5/16" ring connector to the black ground wire and attach it to ground.

Connect the white wire to the "12 volt switched" input on the control module.

Once the switch is installed you can reconnect the positive terminals on both batteries then reconnect the negative terminals.

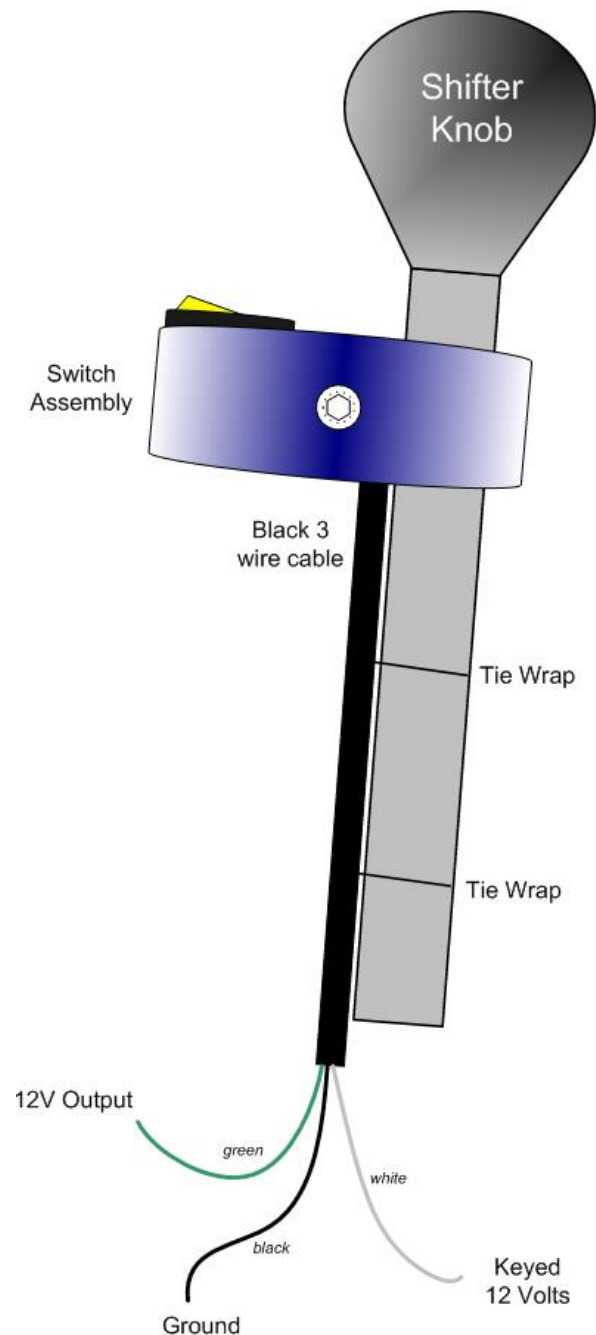

Exhaust Brake Wiring

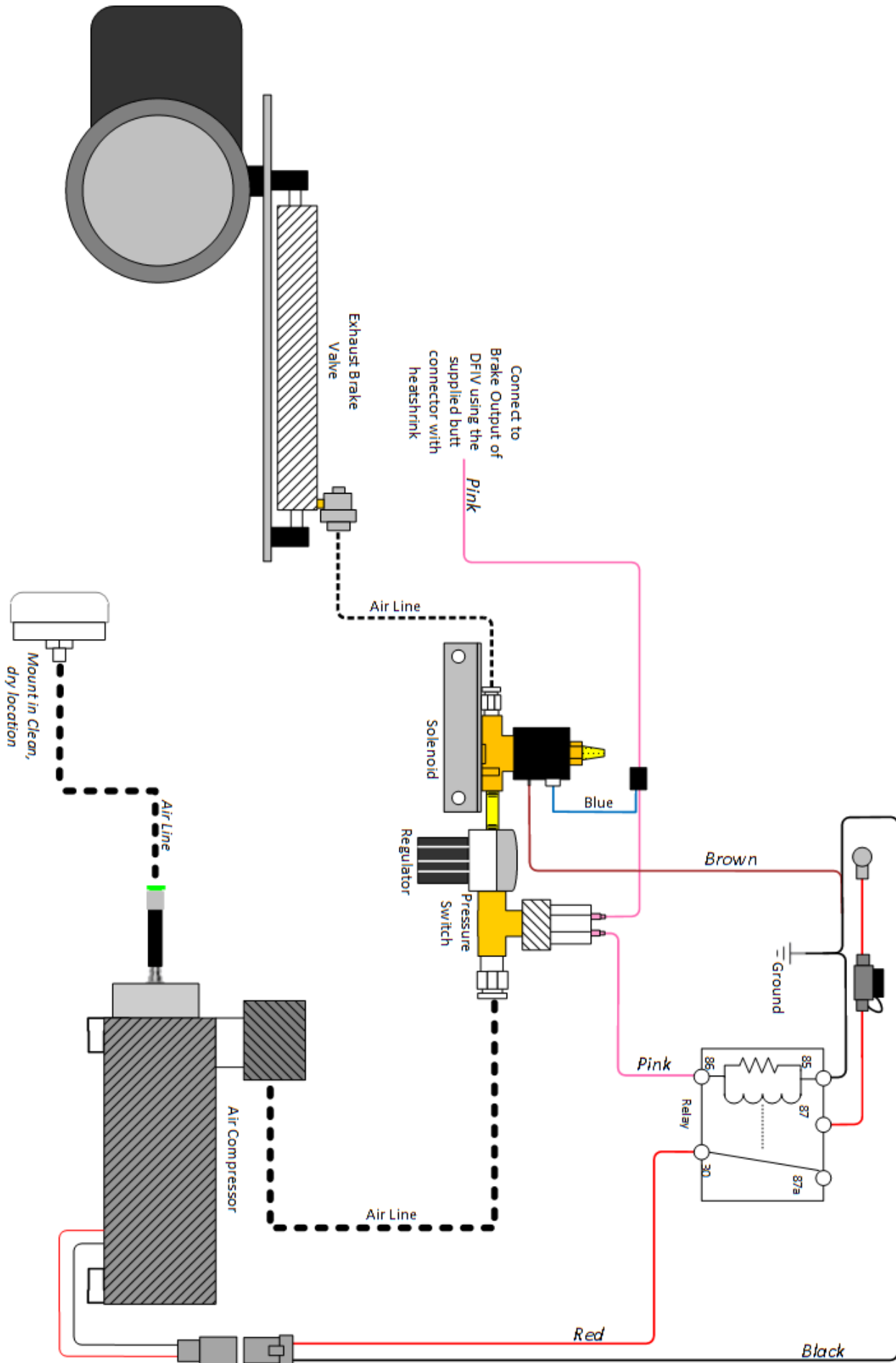

DFIV Calibration

Ensure the connections of the corresponding wires to the DFIV Control Module are correct as shown in the wiring diagram.

To achieve the correct setting for the activation of the exhaust brake in relation to the throttle pedal the DFIV Module must be calibrated for your vehicle.

Connect one end of a test light to the "BRAKE" terminal of the DFIV module and the other end to a good ground.



With the throttle at idle, start the engine and turn on brake switch. Then, using a small flat bladed screwdriver, turn the small adjusting screw in the DFIV Module counterclockwise or clockwise until the test light JUST turns on.

CAUTION: THE ADJUSTING SCREW IS A MICRO-SWITCH THAT IS VERY DELICATE, SO TURN USING SMALL ADJUSTMENTS.

Test by revving up the engine to approximately 1200 RPM and releasing the throttle. As the accelerator pedal is applied the test light should turn off just before the engine starts to rev, indicating proper calibration of the DFIV Module with the APPS.

Then the test light should activate again when the throttle pedal returned to idle. If not, readjust the DFIV Module so that it does. Reinstall lower dash cover.

Maintenance

To extend the life of the exhaust brake, do not operate the vehicle for extended periods of time without activating the brake. On a twice-yearly interval, check and adjust the brake pressure to 10-15 lbs while the engine is at idle. The hoses, wires, fittings and clamps should be inspected on a regular basis for any deterioration, damage, or leaks.

By following the diagrams in this manual, trace hoses and wiring, check continuity through electric components, and check for any lines that are disconnected.

Exhaust Back Pressure Testing Air Actuated Brakes

It is recommend that you purchase the BD pressure gauge kit #1030050



NOTE: The brake stop-bolt and regulator have been preset at the factory and should not need to be adjusted.

You do not need to measure the air pressure in the system, just the exhaust backpressure, which is located on the cast valve.



Idle Pressure Test

With the BD brake engaged and the engine at idle check the exhaust backpressure using a pressure gauge (such as BD PN 1030050) at the test port on the brake valve.

If the back pressure is below 10 psi at idle you have a number of likely causes. The most common being an exhaust leak either at the clamp joint or at the welds (only on some models). Apply the exhaust brake and have someone assist you looking for soot trails or the visible leak. Another culprit would be an exhaust manifold leak, turbocharger gasket leak, turbocharger problem or an EGR issue.

If the back pressure is greater than 15psi, you will need to make an adjustment on the stop bolt. Loosen the jam nut, and lengthen the stop bolt towards the actuator, this will shorten the stroke distance. Only turn 1/4 rotation at a time and re-secure the jam nut. Retest idle pressure.

We generally do not recommend adjusting the stop bolt; please consult BD before doing this as incorrect adjustment can damage the valve and may void your warranty.

Off-Idle Pressure Test & Adjustment

Your BD exhaust brake is a variable-orifice design so when the brake is active and the engine is at higher RPM the brake lever does not rest on the stop bolt. Off-idle backpressure is set by adjusting the air pressure regulator which will in turn increase or decrease off-idle exhaust backpressure. You will need to secure your pressure gauge somewhere that you can see it while you are driving. Using a long extension hose & bringing the gauge into the cab through an open window or clipping it under a windshield wiper works well.

Get the truck up to speed (a downhill grade or a load in the truck is helpful) and activate the exhaust brake. Note the maximum backpressure achieved. You should get peak backpressure at higher RPM (try 3000 RPM in Drive). If you cannot reach the desired backpressure (compare table below) you can begin troubleshooting, the first step is to look for exhaust leaks either from the clamps, exhaust manifolds or feed pipes. Also look for leaks at the clamps located at the back of the turbo and also at the down pipe. If all connections are sealed, you can then use the adjusting regulator to increase the backpressure. Note that small regulator adjustments can have a significant effect on off-idle backpressure.

Turning the regulator **clockwise** will increase pressure.

Turning the regulator **counter clockwise** will decrease pressure.



NOTE: Over the next two weeks, the backpressure at idle may rise due to initial carbon build up on the inside of the brake housing and on the butterfly. The stop bolt may need to be adjusted again to compensate.

Application	Maximum Back Pressure
GM/Chevy 6.5	35 psi
GM/Chevy Duramax	55 psi
Ford Powerstroke	45 psi
Dodge Cummins 1988-98 12V w/o 60lbs Springs	40 psi
Dodge Cummins 1988-98 12V with 60lbs Springs	60 psi
Dodge Cummins 2002 and Newer	60 psi

*HD Spring part# is 1030060.

CAUTION: Do NOT exceed the maximum back pressure value in the exhaust system. Exceeding this pressure will force the exhaust valves open during the intake stroke which could cause engine damage.

Air Brake Troubleshooting Guide

This guide assumes that your exhaust brake system is using a DFIV and a BD air compressor. If your system uses a microswitch for throttle activation, the operation of the air solenoid and pump are the same as with the DFIV. If you are using existing on-board air, check that system as appropriate.

When I let off the throttle nothing happens.	<u>No</u>	<u>Yes</u>
<p>Is the DFIV powering its “brake” output when the throttle is at idle and brake switch and ignition are both on?</p>	<p>Check if DFIV has good power, ground and throttle signal. Check DFIV adjustment. If these things check out, but the DFIV won’t power the “brake” output, the DFIV is likely faulty.</p> <p>Also check power & ground at pump relay and make sure the air solenoid has a good ground.</p>	<p>Check that when air solenoid is powered it will allow air to flow from the #2 port out the #1 port.</p> <p>Check that pump relay is powering pump. If pump has power but does not run, pump is likely faulty. Check for power & ground at pump relay, if these are good but relay does not click or does not power pump, relay is likely faulty.</p>
The brake comes on but there’s little or no holdback	<u>No</u>	<u>Yes</u>
<p>See if torque converter is staying locked up during deceleration. If not, the engine RPM will fall to idle when the throttle is released. The brake will be ineffective without the torque converter locked up.</p> <p>Check off idle brake pressure. (See back pressure chart) Are you getting maximum allowable backpressure?</p>	<p>Check for exhaust leaks. A small leak can result in a significant decrease in back pressure. If no leaks are found try adjusting air regulator. Check for air leaks in brake system.</p>	<p>Try down shifting more aggressively. More RPM will give more holdback. Transmission or torque converter could be slipping internally.</p>
Everything seems to work, but the brake valve won’t close.	<u>No</u>	<u>Yes</u>
<p>Check that air is reaching brake air cylinder?</p>	<p>Air solenoid or quick release valve are likely stuck, plugged or faulty. Clean or replace as required.</p>	<p>Cylinder or brake valve are seized. Remove the clevis pin on the end of the cylinder rod & see if the valve lever can be moved freely.</p>
<p>The valve lever can be moved freely?</p>	<p>Try dismounting the brake & cleaning the carbon out of it. If this does not work the brake valve will need to be replaced.</p>	<p>The cylinder is stuck and will need to be replaced.</p>
Problem	Solution	
<p>Air compressor runs in short bursts and brake is slow to apply.</p>	<p>There is a restriction in the air system, normally in the regulator or air solenoid. Remove the fittings from the regulator and air solenoid, you will likely find some corrosion or debris caught in them. Clean this out with a pick, small brush, compressed air and WD40 or similar lubricant.</p>	
<p>Air compressor runs continually.</p>	<p>Pump relay is likely stuck on. Check operation of relay & replace as required.</p>	
<p>Brake is slow to release.</p>	<p>Debris or corrosion is restricting the quick release valve or air solenoid. Clean as required. Air solenoid could be too far from brake.</p>	

Thank you and happy motoring,
BD Engine Brake, Inc.