



▼▼ WirthCo Engineering, Inc.

"Understanding and fulfilling customer's needs... since 1980"



WELCOME TO WIRTHCO

WirthCo, a family based company, has entered our fourth decade as a prime manufacturer of practical products for making life easier and safer – at home, in the workplace, on the road, in the campground, and on the water. We are exceedingly grateful for valued employees, customers and suppliers. We are dedicated to continuing our growth based on integrity and service. We are also proud of our heritage of providing innovative, quality products.

Our innovative quality is reflected in over twenty patents and trademarks, a number that continues to grow. Our products have been proven in the laboratory and the marketplace. In addition to marketing our proprietary WirthCo brands, we proudly partner with of the world’s largest and most successful distributors, retailers and OEM’s which have selected WirthCo products for distribution under their own private brands. We invite you to review these pages, and to let us know how we can best serve you today...and during the decades to come.



LEGEND

	Items that help our planet, one product at a time!
	Product is made from recycled material.
-7	Items with part numbers ending in -7 indicates a bulk item (no retail package).
-50	Items with part numbers ending in -50 indicates 50 pieces .

-10	Items with part numbers ending in -10 indicates 10 pieces .
	California Energy Commission Promotes energy efficiency and conservation for electrical products by setting the state's appliance and building energy efficiency standards.
	RoHS Compliant WirthCo believes in the protection of planet Earth against known hazardous materials and continually strives to provide products that comply with the worldwide Restriction of Hazardous Substances Directive (RoHS).

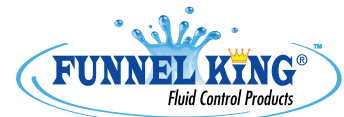

WirthCo products are warranted to be free from defects in material and workmanship for a period of twelve (12) months from the date of purchase. Defective products returned freight prepaid with proof of purchase will be repaired or replaced at the discretion of WirthCo. This warranty does not apply to products that have been altered, improperly installed, maintained or repaired, or damaged by accident, negligence or misuse. Further, all accessories must be returned for warranty credit.

BATTERY DOCTOR

SMART CHARGERS

- 4 Introduction and Icon Key
- 5 Wall Mount Smart Battery Charger/Maintainers
- 6 Rainproof and Sport Smart Battery Chargers
- 7 Smart Charger and Engine Start/Bench Charger
- 8 Smart Battery Charger/Maintainers
- 9 On Board Charger/Smart Chargers
- 10 Battery Isolators/Tester

SOLAR SOLUTIONS

- 11 Solar Light, Mono-crystalline Solar Panels
- 12-13 Amorphous Solar Panels, Solar Kits
- 14 Solar Controllers, Solar Adapter

DISCONNECTS & SWITCHES

- 15 Battery Life Preserver, Remote Disconnects
- 16-17 Knife-Blade Battery Switches
- 18 Disconnects, Switches
- 19 Compact Battery Switches
- 20 Water Resistant Switches, Disconnect Caps
- 21 Heavy Duty Switches
- 22 Toggle Switches
- 23 Rocker Switches
- 24 Push-On Switches, Switch Panels, USB Chargers/Volt Meters
- 25 Battery Bolts + Taps

CIRCUIT PROTECTION

- 26-27 Fuse Kits + Taps
- 27-28 MinBlade, MidBlade, MaxBlade, Low Profile, Glass Fuses
- 29 LED Fuses, Fuse Holders
- 30 Limiter Fuses + Holders
- 31-32 ATO/ATC Glass Fuse Holders
- 33 ATM/MINI Fuse Holders
- 34 Low Profile Micro² Fuse Holders, Wire Nuts
- 35-36 Fuse Blocks + Panels
- 37 Circuit Breakers

TERMINALS

- 38 Crimp Caps, Bullet Connectors, Disconnects, Butt Connectors
- 39 Ring Terminals, Heat Shrink Butt Connectors, Spade Terminals, IDC Connectors

BATTERY ACCESSORIES

- 40-41 Cable Ties, Trailer Wire Accessories, Heat Shrink Tubing
- 42-43 Battery Filler Accessories, Cleaning Brushes, Wire Tools

PRIMARY WIRE

- 44-45 Primary Wire, Crosslink Wire

MARKETING

- 46-48 Split Loom Tubing, Retail Displays
- 49 Retail Displays, Switch/Light Display Box, LED Writing Board

FUNNEL KING

DRUM FUNNELS

- 50-51 Drum Funnel, Drain Pans

FLUID CONTROL

- 52 Measuring Containers
- 53 Containers, Monster Funnel
- 54-55 Galvanized Funnel, Grease Guns
- 56 Transfer Pumps, Drain Kits
- 57 General Purpose Funnel
- 58-59 Heavy Duty Double Capped Funnel
- 60 General Purpose Funnel

ACCESSORIES

- 61 Spouts and Adapters
- 62 Boot Trays, Third Hand Equipment
- 63 Bumpers, Tuffsack, Safety Shield, Shovel

Battery Doctor® Chargers Safely Charge Your Vehicle For 1 Day, 1 Week, 1 Month or Even a Year+!

Electronic Switching Technology – Battery Doctor® Chargers utilize electronic switching power technology as opposed to the linear technology (transformers) used with most other battery chargers.

Safer to Use – Electronic switching technology chargers do not get warm to the touch, unlike transformer chargers, making them friendlier to use! Battery Doctor® chargers are both short circuit protected and spark proof!

Compact, Portable, and Ultra Light – Our chargers are about half the size and half the weight of other chargers!

Reverse Polarity Protected – Battery Doctor® chargers are reverse polarity protected! Assures no damage to your battery or charger if the leads are connected incorrectly.

Simple and Easy to Use – Easy to follow instructions, clearly defined LED indicators and less complicated than others!

Battery Chargers Icon Key

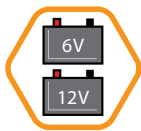

6V/12V Compatibility
Charges 6V and 12V Batteries

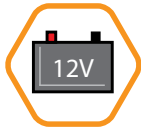

12V Compatibility
Charges 12V Batteries



Multiple Battery Management
Formulated to Safely Charge Wet-Cell, Gel-Cell, Lead-Acid, Calcium and AGM and Deep Cycle Batteries



Auto-Memory
Returns to Last Selected Mode when Restarted



13.6V Equalization Mode
Maximizes Battery Capacity, Reviving Low Voltage Batteries. Returns a Full Hydrometer Reading to Calcium Batteries by Removing Acid Stratification

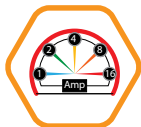

Adjustable Amperage
Multiple Manual Amperage Selection



ETL Approved



Plug-N-Play Connections
EZ-Connects Included for Quick and Safe Connections Between Chargers and Accessories



Multiple Stage Charging
Refresh, Soft Start, Bulk Charge, Absorption, Equalizing, Analysis and Float (Models May Vary)



Refresh Mode
Uses Pulse Charging to Recover and Refresh Deeply Discharged and Sulfated Batteries



Engineered for Safety
Reverse Polarity, Short Circuit, Spark Proof, Overheat and Over-Current and Overcharge



Seasonal Battery Maintenance
Optimized Charge Mode for Cold Weather or AGM Batteries. Maintains and Protects Vehicle Batteries in Storage

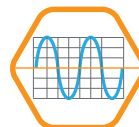

Electronic Switch Mode Technology
Highly Efficient, Automatically Converts Electrical Power to Meet Your Battery's Charging Needs



UL and cUL Approved

BATTERY DOCTOR® 6/12 VOLT 900mA WALL MOUNT™ SMART BATTERY CHARGER/MAINTAINER

- 6/12 Volt - 900mA
- Charges and Maintains Batteries from 5 to 100 Amp Hours
- Smart Battery Technology Prevents Overcharging
- Reverse Hook-Up Protection/Spark Resistant
- Automatic "Switching Technology" can be Safely Connected to the Stored Vehicle for Long Periods of Time
- Easy-to-Read Battery Charge Status LEDs
- Includes Ring Terminal and Alligator Clip Cable Attachments
- Direct Wall Plug-In Design Keeps the Work Area Clutter-Free
- Maintains Batteries up to 200 Amp Hours
- CEC Certified

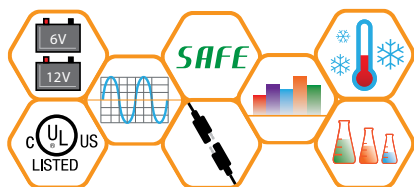

#20026



Accessories Included with #20026 & #20063
See Page 43 for these Replacement Part #'s



BATTERY DOCTOR® 12 VOLT 2 AMP WALL MOUNT™ SMART BATTERY CHARGER/MAINTAINER

- 12 Volt - 2 Amp
- Charges and Maintains Batteries from 5 to 200 Amp Hours
- Smart Battery Technology Prevents Overcharging
- Reverse Hook-Up Protection/Spark Resistant
- Automatic "Switching Technology" can be Safely Connected to the Stored Vehicle for Long Periods of Time
- Easy-to-Read Battery Charge Status LEDs
- Includes Ring Terminal and Alligator Clip Cable Attachments
- Direct Wall Plug-In Design Keeps the Work Area Clutter-Free
- Maintains Batteries up to 400 Amp Hours
- CEC Certified



#20063



SMART CHARGERS

BATTERY DOCTOR® 6/12 VOLT 2 AMP SMART RAINPROOF® BATTERY CHARGER/MAINTAINER

- 6/12 Volt – 2 Amp
- IP65 Water-Resistant Molded Case
- Smart Battery Technology Prevents Overcharging
- Reverse Hook-Up Protection/Spark Resistant
- Automatic "Switching Technology" can be Safely Connected to the Battery for Long Periods of Time
- Easy-to-Read Battery Charge Status LEDs
- Includes Ring Terminal and Alligator Clip Cable Attachments
- Charges and Maintains Batteries from 5 to 200 Amp Hours
- Maintains Batteries up to 400 Amp Hours
- CEC Certified

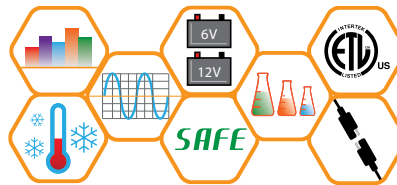

#20067

Accessories Included with #20067 & #20069
See Page 43 for these Replacement Part #'s



BATTERY DOCTOR® 12 VOLT 1.25 AMP SMART SPORT BATTERY CHARGER/MAINTAINER

- 12 Volt - 1.25 Amp
- Smart Battery Technology Prevents Overcharging
- Reverse Hook-Up Protection/Spark Resistant
- Automatic "Switching Technology" can be Safely Connected to the Battery for Long Periods of Time
- Easy-to-Read Battery Charge Status LEDs
- Includes Ring Terminal and Alligator Clip Cable Attachments
- Charges and Maintains Batteries from 5 to 200 Amp Hours
- Maintains Batteries up to 400 Amp Hours
- CEC Certified

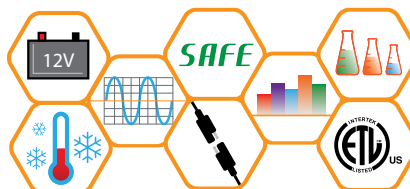

#20069



BATTERY DOCTOR® 12/24 VOLT SMART BATTERY CHARGER/MAINTAINER

- Smart Battery Technology Prevents Overcharging
- 12 Volt/8 Amp - 24 Volt/4 Amp
- Digital Display Shows Voltage and Amperage
- Reverse Hook-Up Protection/Spark Resistant
- Includes Ring Terminals and Alligator Clip Cable Attachments
- LED Read-Out Display
- Wall Mount Hole in Back for Hanging Charger



#20068

BATTERY DOCTOR® 6/12 VOLT 2/10/55 AMP WITH ENGINE START

- For Use on Lead-Acid, Gel Cell and Deep Cycle Marine/RV Batteries
- Charging Modes:
 - Automatic – 12V-10 Amp
 - Manual – 12V-2/55 Amp, 6V-10 Amp
- 55 Amp Engine Start for Emergency Starting
- 6/12V - 10 Amp, Fast Charge for Everyday Charging Needs
- 12V - 2 Amp Trickle Charge for Keeping Stored Vehicles Charged
- Reverse Polarity Protection
- Industrial Grade Alligator Clamps
- Digital LED Meter Displays Both Voltage and Amperage of the Battery
- USB Port for Charging Personal Devices such as Cell Phones and Cameras
- Includes USB LED Flexible Work Light

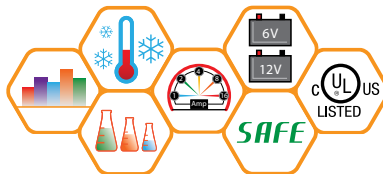

#20093



SMART CHARGERS

BATTERY DOCTOR® 12 VOLT/ 1 & 4 AMP SMART BATTERY CHARGER/MAINTAINER

- 12 Volt - 1/4 Amp
- 7 Stage Smart Battery Technology Prevents Overcharging
- Reverse Hook-Up Protection/Spark Resistant
- Charges and Maintains Batteries from 5 to 400 Amp Hours
- Includes Ring Terminals and Alligator Clip Cable Attachments



#20060



BATTERY DOCTOR® 12 VOLT 500 mA SMART BATTERY CHARGER/MAINTAINER

- 3 Stage 12 Volt Smart Charger Technology Prevents Overcharging
- Smart "Automatic Switching Technology" can be Safely Connected to the Vehicle for Long Periods of Time
- Direct Wall Plug-In Design Keeps the Work Area Clutter Free
- Reverse Hook-Up Protection which is Spark Resistant
- Includes Alligator Clips
- CEC Certified



#20062



SMART CHARGERS

BATTERY DOCTOR® ON-BOARD 6/12 VOLT 1.5 AMP SMART CHARGER

- 6/12 Volt - 1.5 Amp
- Four LEDs for Easy Charging Status Identification
- Reverse Polarity Protected/Spark Resistant
- Molded Plastic Weather Proof Case
- IP 52 Rated
- Includes Mounting Hardware for Automobiles, Boats, Tractors, Golf Carts, and Other Equipment
- Includes Ring Terminals
- CEC Certified

#20028



BATTERY DOCTOR® SMART CHARGER/MAINTAINERS

- 7-Stage Charging Program: Refresh, Soft Start, Bulk Charge, Absorption, Equalizing, Analysis and Float
- Refresh Technology: Breaks Down Internal Battery Resistance Resulting From Sulfation or a Heavily Discharged Battery
- Smart Battery Technology Prevents Overcharging
- Fully Automatic Smart Charging Technology with new Electronic Switching Control Technology
- Automatic "Switching Technology" can be Safely Connected to the Battery for Long Periods of Time
- Water Resistant Enclosure with Coating to Protect Circuit Board
- Automatically Detects Defective Batteries
- Thermal Resistor Automatically Senses the Internal Temperature of the Charger to Avoid Damages Due to Over-Heating or High Ambient Temperature

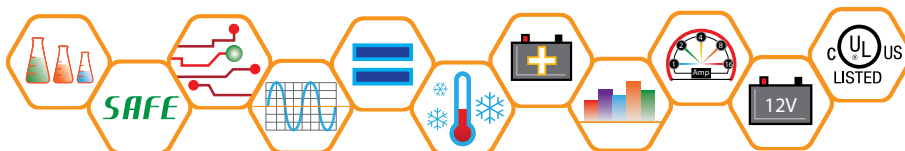

2-4-8 AMP



BATTERY DOCTOR® 2/4/8 AMP 12 VOLT SMART CHARGER

- LED Indicates the Selected Charging Rate (2, 4 or 8 Amps)
- Water Resistant Enclosure with Coating to Protect Circuit Board
- 6 Foot AC Cable and 8 Foot DC Cable Included
- Includes Alligator Clips and Ring Terminal Harness for Multiple Applications

#20085



2-8-16 AMP



BATTERY DOCTOR® 2/8/16 AMP 12 VOLT SMART CHARGER

- LED Indicates the Selected Charging Rate (2, 8 or 16 Amps)
- IP30 Rated Enclosure Designed with Louver for Ventilation
- 6 Foot AC Cable and 8 Foot DC Cable Included
- Includes Alligator Clips and Ring Terminal Harness for Multiple Applications

#20087

SMART CHARGERS

BATTERY DOCTOR® ISOLATOR SERIES

Our new state-of-the-art, fully automatic dual battery isolator is suitable for any vehicle with an auxiliary battery. Smaller and lighter than other standard battery isolators, the Battery Doctor® 100 and 150 Amp Battery Isolators employ electronic switching control technology. Our high-performance electronic isolator allows you to charge two batteries from a single alternator and keeps the starting battery isolated from the second battery. Also, with a single push of the override/reset button, you can change the batteries to parallel mode for jump starting.

- Water Resistant – Suitable for Marine Use, Rated IP62 Potted
- Priority Charging for Starting Battery
- Includes Mounting Bracket
- Over Current and Surge Protected for Vehicles with Electronic Systems
- Manual Override for Starting Battery
- Automatically Charges Auxiliary Battery
- Charge Rate Depends on Alternator Amps
- Isolator Size: 4" x 4" x 2"

#20090 - 100 Amp

#20092 - 150 Amp



Specifications	
Voltage	12 Volt
Charging Current	100 Amp or 150 Amp Peak
Charge Type	Parallel
Control	Electronic
Mounting	Surface / Fire Wall / Battery Side
Current Draw	Charging 50mA (Standby 30mA)
Voltage Draw	None
Surge Protection	Built In
Approval	EMC

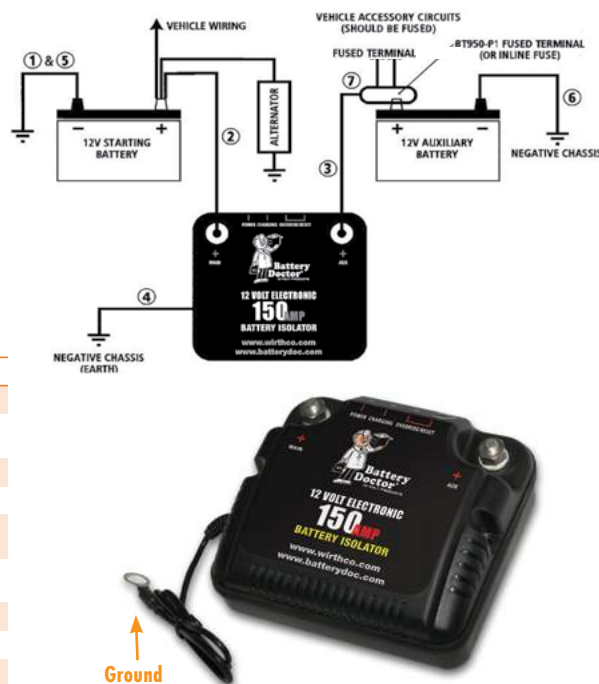

BATTERY DOCTOR® INSTANT "STATE OF CHARGE" TESTER

A push of a button tells you if your battery is weak or fully charged. Simply attach the ring terminals directly onto your battery. If your battery needs charging, simply attach the Battery Doctor® Charger directly to your Battery Doctor® Tester for a simple, tool-free connection.

- Reverse Polarity Protected
- 24" Lead
- 3 Amp Fuse Included



3 Amp Fuse Included

#20040

BATTERY DOCTOR® SURGE PROTECTOR & CHARGE MONITOR

Take the worry out of jumping and recharging your 12 volt battery. Our monitor protects your battery from damaging surges and also displays the battery's condition with indicator lights.

3-IN-1 MONITOR:

- Protects and Displays the Condition of your Battery and Charging System with the Push of a Button
- Protects Engine Computer and 12 Volt Accessories from Damaging Surges when Jump-Starting or Recharging
- Instant Installation
- Includes Two 20" Wire Leads with 5/16" Diameter Ring Terminals
- For All 12 Volt Batteries



#20099

#20099-7



SOLAR CHARGED LED INDUSTRIAL UTILITY LIGHT

- 8 Ultra Bright LED Lights
- 3 AA 600 mAh Ni Mh Rechargeable Batteries
- 14' Charging Lead to Panel and 36" Toggle Switch Cord for On/Off Power
- Indoor and Outdoor Use
- Includes Mounting Hardware (Screws)
- Great for Industrial and Remote Locations where electricity Hook-Ups are Not Available

#23105



MONO-CRYSTALLINE SOLAR PANELS

Battery Doctor® Solar Solutions offer three 12 Volt choices in Mono-crystalline Solar Panels. Mono-crystalline panels are the most efficient solution, over all other models, at converting sunlight to electricity. Since these panels are more efficient you need fewer of them and if you have limited space, these may be a great option.

Kits Include:

- 9' Lead Wire Off Junction Box on back of Panel
- 3' Open Wire with E-Z Connect
- 3' Alligator Clips
- Mounting Brackets and Hardware Included
- Charger Controller Not Included

Includes Mounting Brackets

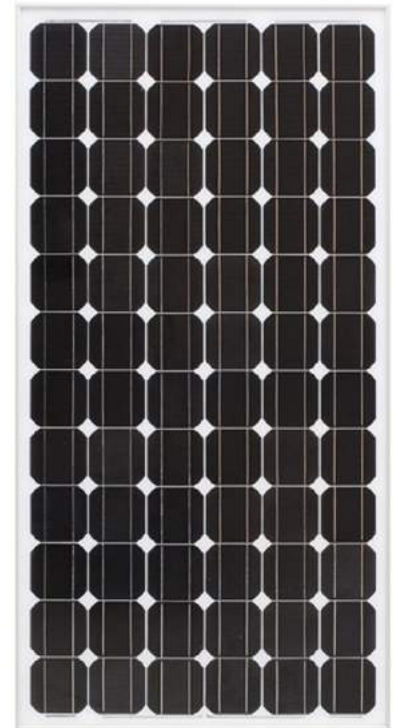
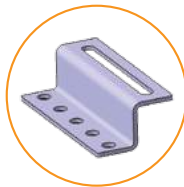

SOLAR CHARGER: 40 WATT PANEL

- Corrosion Resistant Anodized Frame
- Dimensions: 24" L x 20" W x 1.1" D
- Amp Rating: 3.3 Amps

#23130

SOLAR CHARGER: 90 WATT PANEL

- Corrosion Resistant Anodized Frame
- Dimensions: 33.5" L x 26.4" W x 1.4" D
- Amp Rating: 7.5 Amps

#23135

SOLAR CHARGER: 145 WATT PANEL

- Corrosion Resistant Anodized Frame
- Dimensions: 58.5" L x 26.4" W x 1.4" D
- Amp Rating: 12.1 Amps

#23137



MONO-CRYSTALLINE KITS See Page 14 for Controllers + 4-in-1 Adapter

80 WATT WITH 30 AMP CONTROLLER DELUXE KIT

- 40W Mono Panel x 2 (#23130)
- 4-in-1 Adapter (#23129)
- 30A - 12V Controller (#23125)

#23164

90 WATT WITH 30 AMP CONTROLLER

- 90W Mono Panel (#23135)
- 30A - 12V Controller (#23125)

#23165

145 WATT WITH 30 AMP CONTROLLER

- 145W Mono Panel (#23137)
- 30A - 12V Controller (#23125)

#23169

AMORPHOUS SOLAR PANELS

Battery Doctor® Solar Solutions offer a variety of choices in Amorphous 12 Volt Solar Panels. Our Amorphous panels and kits work in all daylight conditions helping you to harness the Sun's Energy! Water resistant, shock and rust resistant. Battery Doctor® has your Go Green Technology covered!

- Converts Daylight into Electricity to Charge 12 Volt Batteries and Extend Battery Life
- Amorphous Solar Panels Charge even in Cloudy and Overcast Weather!
- Implements the Latest Resource with SiGe Technology Helping to Provide you the Most Efficient Panels on the Market!
- Plastic Corner Sleeves Prevent Scratching
- Includes E-Z Connect Adapter
- Built-in Blocking Diode Prevents Reverse Charging
- Includes Mounting Kits for Quick Installation
- Use with Deep Cycle, AGM, Lead-Acid and Gel-Cell 12 Volt Batteries
- Includes Bright LED Current Indicator Attachment

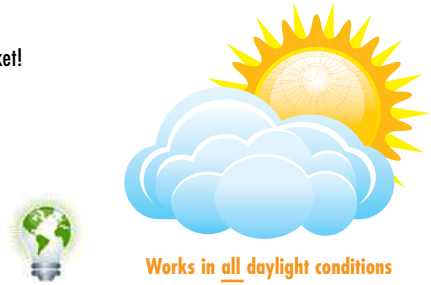

SOLAR PANEL MAINTAINER 1.8 WATT KIT

- Anodized Aluminum Frame
- Dimensions: 12 ½" L x 4" W x 1" D
- Amp Rating: Up to 150 mA
- No Controller Needed for Single 12 Volt Battery Application

Accessories Included:

- Male Output 12V Adapter (Cigarette Lighter Adapter)
- LED Voltage Indicator
- Alligator Clips
- Included Hardware: Tilt Rods (2)
- Plug and Play Bullet Connection System

Accessories Included with #23140 & #23143



SOLAR PANEL TRICKLE CHARGER/ MAINTAINER 5 WATT KIT

- Anodized Aluminum Frame
- Dimensions: 12 ½" L x 12 ½" W x 1" D
- Amp Rating: Up to 420 mA

Accessories included:

- Male Output 12V Adapter (Cigarette Lighter Adapter)
- Alligator Clips
- LED Voltage Indicator
- Included Hardware: Tabs and Screws
- Plug and Play Bullet Connection System



#23140

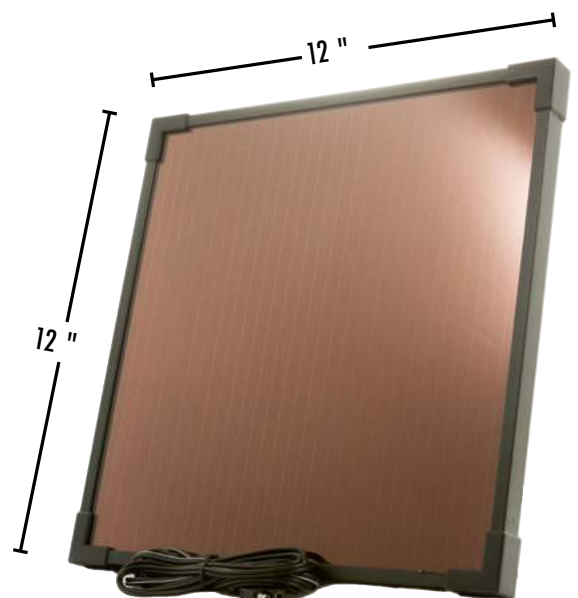

#23143

SOLAR PANEL CHARGER/MAINTAINER 9 WATT KIT

- Anodized Aluminum Frame
- Dimensions: 24.4" L x 8.3" W x 1" D
- Amp Rating: Up to 750 mA
- Controller Needed for 12 Volt Battery

Accessories included:

- Male Output Adapter (Cigarette Lighter Adapter)
- Alligator Clips
- LED Voltage Indicator
- Hardware Included: Tabs and Screws
- Plug and Play Bullet Connection System



#23144



Accessories Included with #23144

SOLAR PANEL CHARGER/MAINTAINER 20 WATT KIT

- Aluminum Frame with Plastic Edging
- Dimensions: 46" L x 15" W x 2" D
- Amp Rating: Up to 1.7 Amps
- Controller Needed for 12 Volt Battery

Additional Accessories included:

- 12 Volt Socket Cable
- Battery Cable
- 18" Male 12V Socket Adapter
- 18" Female 12V Socket Adapter
- 21" Solar Controller Connecting Wire
- 36" Alligator Clips
- 4 Screw Holes in Each Corner
- Plug and Play Bullet Connection System

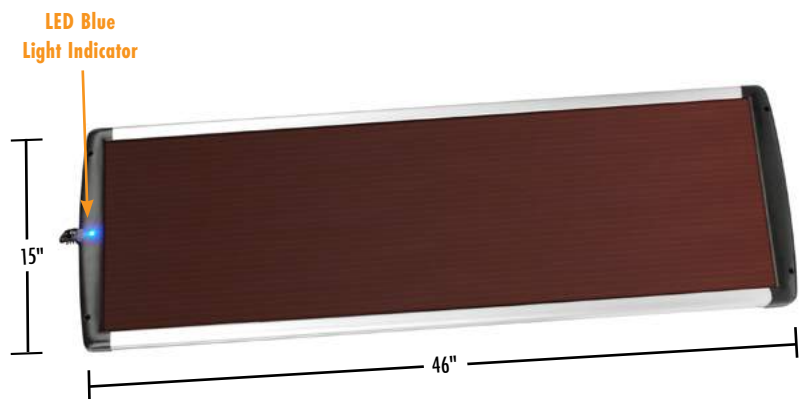

#23145



AMORPHOUS SOLAR PANEL KITS AVAILABLE FOR INCREASED SOLAR POWER



4-1 Adapter
#23129



20 Watt Panel
#23145



10 Amp
Controller
#23122

20 WATT W/ 10 AMP CONTROLLER

- 20W Panel (#23145)
- 10 Amp Controller (#23122)

#23167

40 WATT W/ 10 AMP CONTROLLER

- 20W Panel (#23145) x 2
- 4-In-1 Adapter (#23129)
- 10 Amp Controller (#23122)

#23147

60 WATT W/ 10 AMP CONTROLLER

- 20W Panel (#23145) x 3
- 4-in-1 Adapter (#23129)
- 10 Amp Controller (#23122)

#23149

80 WATT W/ 10 AMP CONTROLLER

- 20W Panel (#23145) x 4
- 4-in-1 Adapter (#23129)
- 10 Amp Controller (#23122)

#23148

BATTERY DOCTOR® SOLAR SOLUTIONS FOR 12 VOLT BATTERIES



	Part #	Wattage	Maintain	Trickle Charge	Charge	Solar Controller	Applications
Amorphous Panels	23140	1.8	x				Cars, RVs, ATVs, Motorcycles, PWC, Electric Bicycles, Motorscooters and Small Boats
	23143	5	x	x			
	23144	9	x	x	x	Recommended	Riding Lawn Mowers, Med Sized Boats, Trucks, Motorcycles, ATV's and Autos, Fence Chargers, Deer Feeders, Sump Pumps, Electronic Gates and Small Portable Electronics
	23145	20	x	x	x	Required	Boats, RVs, Tractors, Combines, Trucks and Smaller 12 Volt Back Up Generator Power Systems
Monocrystalline Panels	23130	40	x	x	x	Required	Will help charge and maintain: RV's, Combines, Boats, Larger 12 Volt Back Up Power Systems, and Off Grid Applications
	23135	90	x	x	x	Required	
	23137	145	x	x	x	Required	



SOLAR CONTROLLERS

12 VOLT 30 AMP DIGITAL SOLAR CONTROLLER

- Charges, Maintains and Regulates 12 Volt Batteries from Overcharging and Discharging
- LED Indicators Show Four Levels of Charging Status
- Easily Mounted in Weather Protected Area
- Handles Up to 30 Amps of Array Current and Up to 500 Watts of Solar Power
- Continuously Displays the Charging Current or Battery Voltage on the LCD Digital Meter
- Automatically Indicates the Charged Condition of the Battery on the LED Bar Graph
- For Use with Gel-Cell, AGM, Deep Cycle and All Lead-Acid 12 Volt Batteries
- Hardwire Hook-Up



#23125

12 VOLT 10 AMP SOLAR CONTROLLER

- Maintains and Regulates 12 Volt Batteries From Overcharging and Discharging
- Handles Up to 10 Amps (120 Watts) of Array Current
- Maintenance-Free Protection of Your Solar Panel and Batteries
- Maintains 12 Volt Batteries in a Fully Charged State
- Small, Compact and Easy to Mount
- For Use with Gel-Cell, AGM, Deep Cycle and All Lead-Acid 12 Volt Batteries
- Easily Mounted in Weather Protected Area
- Plug and Play Bullet Connections



#23122

4-IN-1 SOLAR PANEL ADAPTER

Maximize Your Solar Panels' Output!

- Safely Connects Up to 4 Like Solar Panels in Parallel
- 11' 6" Long
- Includes 4 Bullet E-Z Connectors
- Quick and Easy to Use: No Cutting or Splicing!
- Max Wattage: 80 Watts



#23129

#23129-7



BATTERY LIFE PRESERVER™ AUTOMATIC BATTERY DISCONNECT SWITCH

This state-of-the-art electronic device automatically monitors your battery capacity. It prevents your battery from going dead by automatically disconnecting the battery at 12.0 volts, therefore reserving enough power to start the vehicle.

- Automatically Disconnects the Vehicle's Battery at 12.0 Volts
- Connect and Disconnect the Battery with the Touch of a Button on the Wireless Remote
- Helps Prevent the Following: Being Stranded, Dead Battery, Jumper Cables, Towing, Emergency Calls
- Anti-Theft Device when Activated
- Easy Bolt-On Installation: Does Not Require Any

- Cables to Be Cut
- Included 2 Key Fobs and Mounting Hardware
 - Side Post Battery Needs #30300 Bolt (Not Included - See Page 25)
 - 200 Amps Continuous
 - 1100 Amps Peak

#20395



REMOTE ELECTRIC DISCONNECT SWITCH

- Switch Manually from Remote Location via Rocker/Toggle Switch
- LED Status Identification for Remote Control Switch
- 9.5VDC - 32VDC
- 275 Amps Continuous
- 455 Amps Intermittent
- 1,250 Amps Cranking
- Power Draw: Switch Off 12mA; Switch On 15mA

#20370-7



BATTERY DOCTOR® MINI MASTER BATTERY DISCONNECT SWITCHES

- For Application Up to 48 Volts
- ISO 8846 Approved
- Continuous Rating: 300 Amps
- Intermittent Rating: 1000 Amps/5 Seconds
- Crank Rating: 700 Amps/10 Seconds
- Can Be Used with 1 or 2 Batteries
- Dimensions: 2 3/4" L x 2 3/4" W x 3" H
- Recess, Flush Top Mount
- Label Glows in the Dark
- Removable Backplate
- Cable Knockout Plate on All Sides



#20387



#20393

#20387 – Single Battery Disconnect Switch - 2 Position

#20387-7

#20393 – Dual Battery Disconnect Switch - 4 Position

#20393-7



DISCONNECTS & SWITCHES

Our patented Battery Doctor® switches are easy to install and simple to use.

All of Our Knife-Blade Switches:

- Mount on Negative Battery Post Only
- Disconnect Batteries Quickly and Easily
- Stop Unwanted Battery Drain
- Help Prevent Theft, Tampering and Unauthorized Use
- Improve Safety and Security of Stored Vehicles, RVs and Seasonal Equipment
- Are Rated 250 Amps Continuous and 750 Amps Surge at 12 Volts

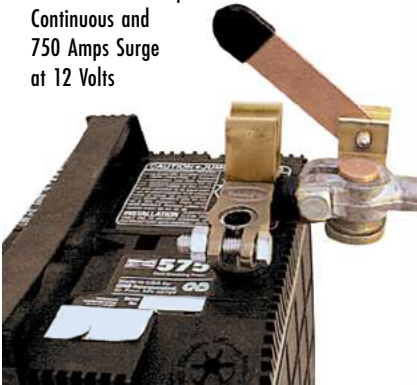

FOR TOP POST BATTERIES, LOW PROFILE HORIZONTAL OPERATION

Opens and Closes Horizontally Where Clearance Above the Battery is Limited - Install on Negative Post Only



- With Post for Receiving Standard Battery Cable Clamp
- 3 1/2" W x 3 3/4" L x 1 1/2" H

#20108
#20108-7



- With Post, Plus 1/8-18 Stud and Wing Nut for Extra Connections
- 3 1/2" W x 3 3/4" L x 2 1/2" H

#20109
#20109-7

FOR TOP POST BATTERIES, LOW VERTICAL OPERATION

Switches recommended to mount on negative battery post to disconnect ground and battery. Easy to reach and operate.

- With 5/8" Diameter Post for Receiving Standard Battery Cable Clamp
- 3" W x 4" L x 2" H



#20138
#20138-7

- With 5/8" Diameter Post, Plus 1/8-18 Stud and Wing Nut for Extra Connections
- 3" W x 4" L x 2 1/4" H

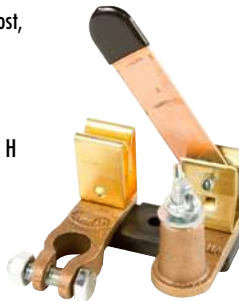

#20148
#20148-7

- With 1/8-18 Bolt for Receiving Eyelet Cable Connectors
- 3" W x 4" L x 2" H



#20168
#20168-7

12/24-VOLT HEAVY AG EQUIPMENT SWITCH

Double-pole, double-throw switch connects two 12 volt batteries either in parallel for maximum current and charging, or in series for 24 volt starting power. Instructions included.

- Great for Bench Testing Rebuilt Starters and Alternators, Plus Other 12 or 24 Volt Applications
- Open Switch Disconnects Both Batteries for Storage or Electrical Work
- Surface Mounted
- 4 3/4" W x 6 3/8" L x 2" H

#20238-7

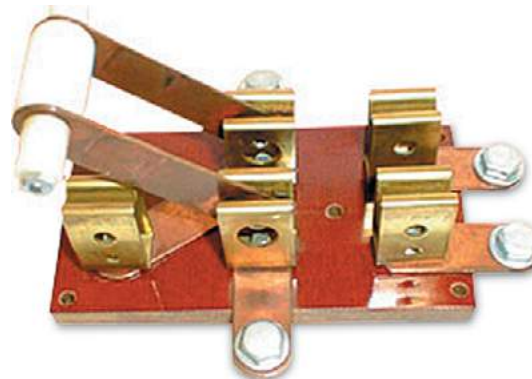

SURFACE MOUNTED "IN-LINE"/REMOTE MOUNT SWITCHES

For concealed installations, or where battery box space is limited. Connects to the negative battery cable; other side connects to the vehicle cable.

- Both Terminals are $\frac{5}{16}$ " Bolts for Receiving Eyelet Cable Connectors
- 3" W X 4" L X 2" H



#20188
#20188-7

- One Terminal is $\frac{5}{8}$ " Post for Receiving Standard Battery Cable Clamp, the Other Terminal is $\frac{5}{16}$ " Bolt for Receiving Eyelet Cable Connector
- 3" W x 4" L x 2" H



#20198
#20198-7

DUAL BATTERY SWITCHES

Allows use of one battery for accessories while reserving second battery for starting. Selected battery is connected to provide power and receive charging from vehicle; non-selected battery remains idle. Surface mounted.

- Single Blade Selects Either Battery
- 2" W x 6 $\frac{1}{2}$ " L x 2" H



#20218
#20218-7

- Double Blade Selects Either or Both Batteries
- 2" W x 6 $\frac{1}{2}$ " L x 2" H



#20228
#20228-7

FOR SIDE TERMINAL BATTERIES

- Mounts on Negative Side Battery Terminal
- Provides $\frac{3}{8}$ "-18 Bolt for Receiving Standard Eyelet Cable Connector
- 3 $\frac{1}{4}$ " W x 3 $\frac{3}{4}$ " L x 1 $\frac{1}{2}$ " H

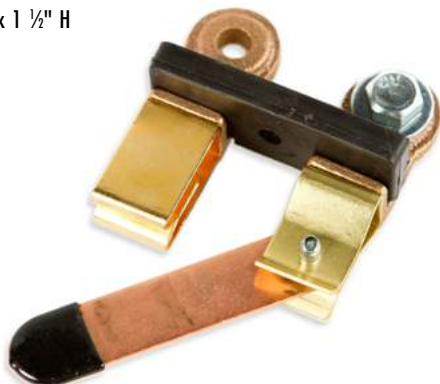

#20128
#20128-7

DOUBLE POST ACCESSORY SWITCH

Allows uninterrupted power to vehicle while switch controls power to accessory equipment. Ideal for use with winches, snow plows, generators and to power pick-up camper accessories.

- Mounts on Negative Top Post of Battery. Provides One Un-switched $\frac{5}{8}$ " Post, Plus One Switched $\frac{5}{8}$ " Post
- 3 $\frac{1}{4}$ " W x 4" L x 2" H



#20208
#20208-7

DISCONNECTS & SWITCHES

ROTARY SWITCH

- Master Battery Isolator Disconnect Switch
- 100 Amps Continuous at 12 Volts, 500 Amps Surge at 12 Volts
- Requires 3/4" Hole for Mounting



Two 10mm Threaded Studs with Nuts



#20304
#20304-7

UNIVERSAL IGNITION SWITCH

- Master Battery Isolator Disconnect Switch
- 30 Amps Continuous at 12 Volts
- Mounting Stem 7/16", 3/4" Diameter
- 1 1/8" Mounting Nut
- Two Brass Keys Included
- 4 Stud Terminals (#10-32 Thread)



#20275-7

4 POSITION MASTER BATTERY DISCONNECT ISOLATOR & SELECTOR SWITCH

- For Application 6-36 Volts
- 4-Position: Both/1/2/Off
- Includes Four Mounting Holes for Easy Access
- Intermittent Rating: 500 Amps
- Mounting Dimensions: 5 3/4"
- Overall Height: 2 5/8"
- Surface or Panel Mount



4 pre-drilled mounting holes



#20360-7

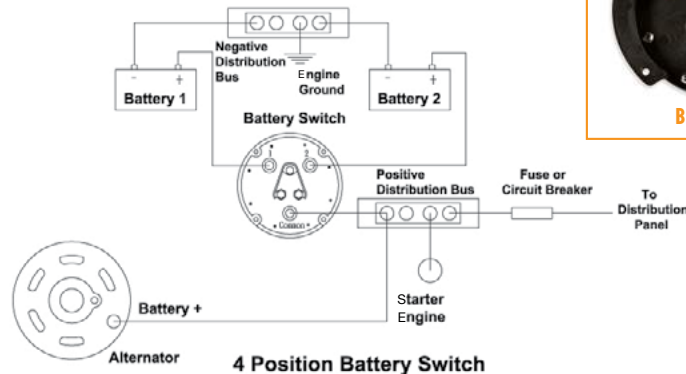

Back View

4 Position Battery Switch

LOCKING KEY-STYLE BATTERY DISCONNECT SWITCH

- New Locking Key Switch to Help Prevent Tampering and Unauthorized Use!
- 200 Amps Continuous at 12 Volts
- Crank Rating: 1000 Amps for 5 Seconds
- Dimensions: 4" W x 4" D
- Includes 2 Keys
- Panel Mounted



#20279-7

MASTER DISCONNECT SWITCH

- Prevent Theft, Tampering and Unauthorized Use
- Stop Unwanted Battery Drain
- 175 Amp Continuous, 1,000 Amp Peak

10mm Threaded Studs with Nuts



#20269
#20269-7

All of Our Compact Battery Switches Feature:

- Easy to Install on Negative Battery Post
- Battery is Disconnected by Unscrewing the Knob a Few Turns, and Reconnected by Tightening the Knob
- Knob Can be Removed Completely to Deter Theft
- Compact Size Fits Most Battery Compartments
- Rated 500 Amps Surge and 125 Amps Continuous at 12 Volts

- #20309 and #20310 Include a 15 Amp Fused Bypass that Maintains Computer Settings, Radio, Clock, Etc., while Battery is Disconnected
- Retail Package Includes Battery Terminal Markers #20250, as Shown on Page 43



TOP MOUNT WITHOUT FUSED BYPASS



#20308
#20308-7

SIDE MOUNT WITHOUT FUSED BYPASS



#20307
#20307-7

TOP MOUNT WITH FUSED BYPASS



#20309
#20309-7

• (For more information on In-Line Fuse Holder #20311, please see page 33)

SIDE MOUNT WITH FUSED BYPASS



#20310
#20310-7

• (For more information on In-Line Fuse Holder #20311, please see page 33)

QUICK RELEASE BATTERY BOLTS

- Anti-Corrosive Steel Bolts
- Replaces Standard 3/16" Battery Terminal Bolt
- Color-Coded Polypropylene Levers
- No Tools Required
- Cam Action Tightens and Loosens Bolts
- Heat Treated Steel
- Sold in Pairs

The secret...
is the cam action!

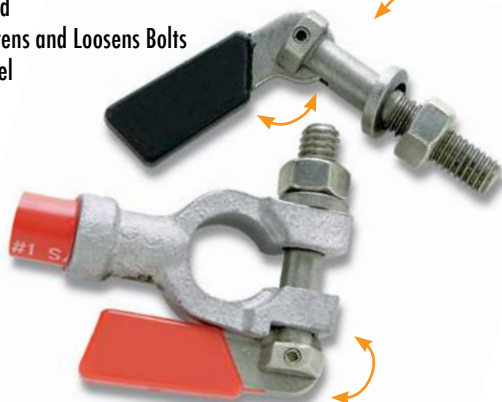

#20251
#20251-7

QUICK DISCONNECT BRASS BATTERY TERMINAL

- Designed for Both Round and Square Battery Lugs
- Quickly Isolates the Vehicle's Battery, Allowing Clock, Radio, etc. to Remain Functional When Used with a Fused Bypass
- To Isolate the Starter Circuit Only, Unscrew the Knob (It is Not Necessary to Remove the Knob)



#20350-7

DISCONNECTS & SWITCHES

WATER-RESISTANT MASTER SWITCH

- Excellent for Marine or Automotive Use
- Rated 100 Amps Continuous, 500 Amps Surge at 12 Volts
- Rated 50 Amps Continuous, 250 Amps Surge at 24 Volts
- 2 1/4" Diameter X 2 1/2" Deep 1 1/4" Deep Behind Panel
- Two 3/16" Diameter Mounting Holes



- #20314 – Retail Kit Includes: 1 Switch, 1 Water-Resistant Cover, and 2 Keys
- #20314-7 – Bulk with All Items Above
- #20312-7 – Water-Resistant Cover Only
- #20315-7 – Switch With 1 Key, Unpackaged (Cover Not Included)
- #20316-7 – Key Only



Actual in-use application!

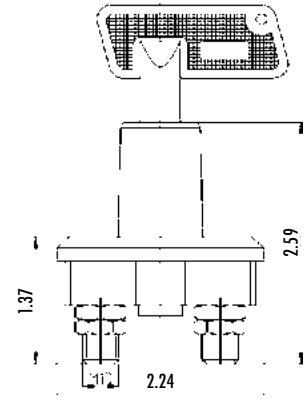
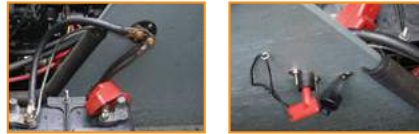

Measurements are in inches

BATTERY AND ALTERNATOR WATER-RESISTANT MASTER SWITCH

- Reduces Risk of Alternator Circuit Damage Due to Heavy Voltage Surge 100 Amps Continuous at 12 Volts 500 Amp Surge

Includes:

- Water-Resistant Cover
- 1 Key
- 3 Ohm 11 Watt Resistor and Wiring Diagram



#20319-7

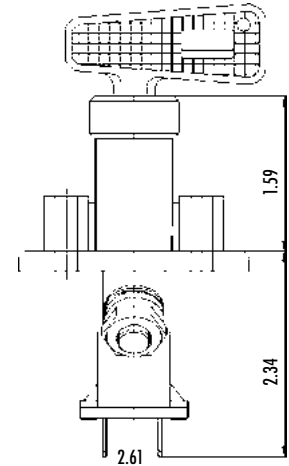
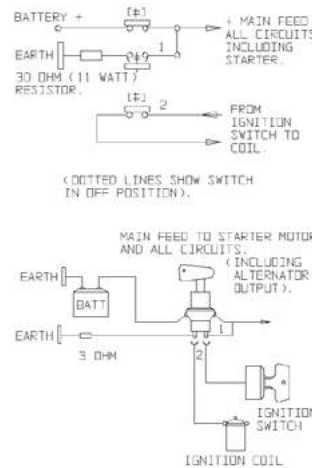
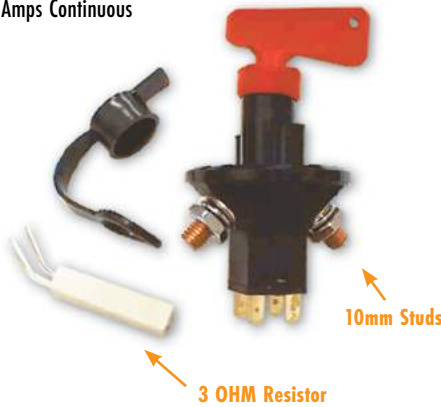

Measurements are in inches

EMERGENCY PUSH BUTTON BATTERY DISCONNECT SWITCH

"Twist to connect...push to disconnect!"

- Allows Electrical Circuit of Vehicle to Be Killed With Push of Button
- To Operate, Twist the Red Button Until it Clicks into "On" Position to Make Contact; to Turn Switch Off, Just Press the Button!
- Heavy Duty – Weighs 1lb 5oz
- Rated 250 Amps Continuous, 2500 Amps Surge at 12 Volts for 5 seconds
- Ideal for Emergency Vehicles, Industrial, Agricultural, Marine, Automotive and All Heavy Duty Industrial Use

#20256-7

Two 10mm Threaded Studs with Nuts →



BATTERY QUICK DISCONNECT CAPS

- Fits Top Post Batteries
- Manufactured of Copper-Zinc Plated Steel
- Fits Side Post Batteries (with Standard Post Adapters)
- Attach to Battery Terminal by Clamping Down on Cap
- Lift Cap to Remove from Battery Terminal
- Rated 500 Amps Continuous, 800 Amps Surge at 12 Volts
- Color-Coded Caps: Red and Black
- Sold as a Pair
- Accepts 4-6 Gauge Wire

#20158
#20158-7



HEAVY DUTY DUAL BATTERY SWITCH

"Key turns 90° to instantly connect or disconnect dual batteries"

- Engages or Disconnects Two Batteries Simultaneously
- Rated 250 Amps Continuous, 2500 Amps Surge at 12 Volts for 5 seconds
- Two 1/2" Diameter Mounting Holes on 4" Centers
- Key is Captive in "On" Position and Removable in "Off" Position
- Weather-Resistant Cover and 1 Key Included
- 5 1/2" L x 4 1/8" W x 5" D (3" Deep Behind Panel)



#20258-7



Incorporates Flange for **Panel Mounting** from Front or Rear For Discreet Appearance.
Panel Mounting from Rear Requires Only a Single Center Hole Plus Two Mounting Holes

HEAVY DUTY SINGLE BATTERY SWITCH

"Key turns 90° to instantly connect or disconnect the battery"

- Rated 250 Amps Continuous, 2500 Amps Surge at 12 Volts for 5 Seconds
- Two 1/2" Diameter Mounting Holes on 4" Centers
- Key is Captive in "On" Position and Removable in "Off" Position
- Weather-Resistant Cover and One Key Included
- 5" L x 2 1/2" W x 4 5/8" D (3" Deep Behind Mount Panel)

#20259-7



FIXED HANDLE BATTERY DISCONNECT SWITCH

"Turn to connect...turn back to disconnect!"

- Heavy Duty Removable Handle/Key
- Allows Electrical Circuit to Be Switched On and Off With a Turn of the Handle/Key
- Rated 500 Amps Continuous, 5000 Amps Surge at 12 Volts for 5 Seconds
- Water Resistant

#20257-7
Fixed Handle
Version



#20247-7
Lockout Plate Version



#20243-7
Key Version



#20257-7 – Fixed Handle Without Lockout Plate

#20247-7 – Fixed Handle With Lockout Plate

#20243-7 – Keyed Switch

#20245-7 – Key Only

#20246-7 – Lockout Plate Only

DISCONNECTS & SWITCHES

PULL ON/PUSH OFF SWITCH

- Screw Terminal Wire Connection
- Long Neck for Thicker Panels
- Requires $\frac{3}{16}$ " Hole for Mounting
- Rated 16 Amps at 12 Volts



#20300
#20300-7

ILLUMINATED TOGGLE SWITCH

- Two-Position On/Off
- Illuminates in "On" Position
- Requires $\frac{1}{2}$ " Hole for Mounting
- Includes Nut and Back-Up Collar for Mounting
- Rated 20 Amps at 12 Volts



Part #	Bulk	Color
20500	20500-7	Illuminated Red
20501	20501-7	Illuminated Green
20502	20502-7	Illuminated Amber
20503	20503-7	Illuminated Blue

MICRO TOGGLE SWITCH

- Two-Position On/Off
- Requires $\frac{3}{16}$ " Hole for Mounting
- Rated 6 Amps at 12 Volts



#20512
#20512-7

PLASTIC TOGGLE SWITCHES - 2 OR 3 POSITIONS

- Requires $\frac{1}{2}$ " Hole for Mounting
- Includes Nut and Back-Up Collar for Mounting
- Rated 20 Amps at 12 Volts



Part #	Bulk	Position
20505	20505-7	2-Position "On/Off"
20507	20507-7	3-Position "On/Off/On"

METAL TOGGLE SWITCH

- Two-Position On/Off
- Screw Terminals
- Requires $\frac{1}{2}$ " Hole for Mounting
- Rated 20 Amps at 12 Volts



#20511
#20511-7

HEAVY DUTY METAL TOGGLE SWITCH

- High Current Switch
- Requires $\frac{1}{2}$ " Hole for Mounting
- Rated 25 Amps at 12 Volts

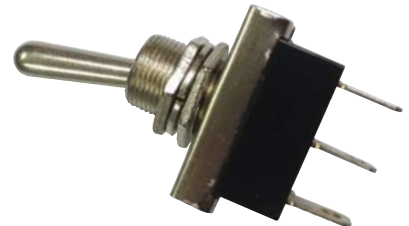

Part #	Bulk	Position
20508	20508-7	3-Position "On/Off/On"
20509	20509-7	Momentary On/Off
20514	20514-7	2-Position "On/Off"

SHORT CHROME TOGGLE SWITCH

- Two-Position On/Off
- Space-Saving Duckbill Toggle
- Requires $\frac{1}{2}$ " Hole for Mounting
- Rated 20 Amps at 12 Volts

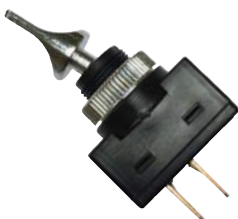

#20506
#20506-7

HEAVY DUTY LED ILLUMINATED TOGGLE SWITCH

- Two-Position On/Off
- Super Bright LED on Toggle
- Requires $\frac{1}{2}$ " Hole for Mounting
- Rated 25 Amps at 12 Volts

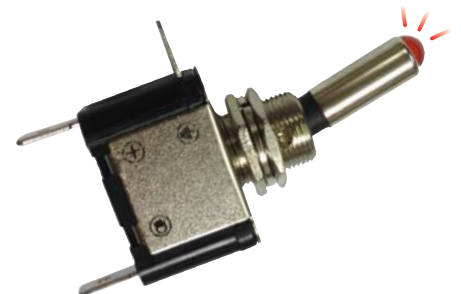

Part #	Bulk	LED Color
20520	20520-7	Amber
20521	20521-7	Blue
20522	20522-7	Green
20523	20523-7	Red

ROCKER SWITCH

- Two-Position On/Off
- Requires $\frac{13}{16}$ " x $\frac{1}{2}$ " Slot for Mounting
- Rated 16 Amps at 12 Volts



#20525
#20525-7

PROTECTIVE TOGGLE COVERS

- Aircraft Style Toggle Covers
- Prevents Accidental Switching



Part #	Bulk	Cover Color
20560	20560-7	Blue
20561	20561-7	Carbon
20562	20562-7	Camouflage
20563	20563-7	Chrome
20564	20564-7	Green
20565	20565-7	Red
20566	20566-7	Yellow

ON/OFF LED ILLUMINATED ROCKER SWITCH

- Two-Position On/Off
- Super Bright Orange LED
- Requires $\frac{3}{4}$ " x $\frac{13}{16}$ " Slot for Mounting
- Rated 20 Amps at 12 Volts



#20530
#20530-7

ILLUMINATED ROCKER SWITCH

- Two-Position On/Off
- Requires $\frac{13}{16}$ " x $\frac{1}{2}$ " Slot for Mounting



Part #	Bulk	Amp at 12V	Color
20531	20531-7	20A	Illuminated Amber
20532	20532-7	20A	Illuminated Red

12 VOLT INDICATOR LIGHT

- Super Bright 12V Light Captures Attention
- Chrome Bezel
- Requires $\frac{1}{2}$ " Hole for Mounting
- Rated 12 Volts



Part #	Bulk	Color
20540	20540-7	Amber
20541	20541-7	Blue
20542	20542-7	Green
20543	20543-7	Red

OVAL LED ILLUMINATED ROCKER

- Two-Position On/Off
- Super Bright LED Illuminates Amber in the On Position
- Requires $\frac{1}{2}$ " Hole for Mounting
- Rated 16 Amps at 12 Volts



#20554
#20554-7

ILLUMINATED PUSH ON/OFF SWITCH WITH SPLASH PROOF SEAL

- Push On / Push Off
- Super Bright Red LED
- Requires $\frac{3}{4}$ " Hold for Mounting
- Rated 10 Amps at 12 Volts



#20533
#20533-7

RED ILLUMINATED ON/OFF ROCKER SWITCH

- Two-Position On/Off
- Super Bright Red LED
- Requires 1" Hole for Mounting
- Rated 20 Amps at 12 Volts



#20550-7

SWITCH PANELS

- Precut – Making Installation Easy
- Durable ABS Plastic
- Paintable



Part #	Bulk	Size/Shape
20590	20590-7	13/16" x 1/2" Slot Panel
20591	20591-7	1/2" Round Hole Panel

ROCKER SWITCH PANEL

- Two-Position On/Off Rocker Switch
- Rocker Illuminates Red
- Rated 20 Amps at 12 Volts



#20595
#20595-7

TOGGLE SWITCH LIGHT ASSEMBLY KIT

- Two-Position On/Off Toggle
- Illuminates in "On" Position
- Super Bright Red Indicator Light
- Includes Modular Mounting Bracket
- Rated 20 Amps at 12 Volts



#20510
#20510-7

DISCONNECTS & SWITCHES

MOMENTARY PUSH-ON BUTTON SWITCH

For controlling apparatus that requires temporary power and manned operation.

- Heavy Duty Momentary Push-On Switch
- Water-Resistant Cover
- 30 Amps at 12 Volts



#20303
#20303-7

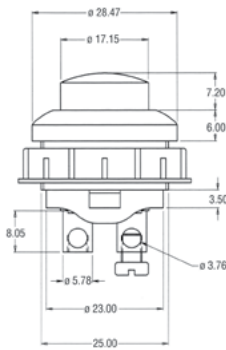

Measurements are in millimeters

DIE-CAST PUSH-ON STARTER SWITCH WITH COVER

- Heavy Duty Die Cast Push-On Starter Switch, Momentary On
- Water-Resistant Cover
- 16 Amps at 12 Volts
- 5/8" Diameter Mounting Hole Required for Panel Mount



#20302
#20302-7

START/IGNITION PANELS - 2 OR 3 SWITCH

- 2 or 3 Switches, Plus 1 LED
- Polished Aluminum Panel
- Toggle Switch with Cover – 25 Amps at 12 Volts
- Red Indicator Light
- Starter Button – 16 Amps at 12V
- 4 Mounting Holes



#20280 – 2 Switch/1 LED
#20280-7
#20283-7 – 3 Switch/2 LED

EMERGENCY CUT-OFF SWITCH

- Emergency Cut-off Switch
- 12A - 15A
- Lanyard Length: 17"
- Four Prong Connectors for Use with Coil or Magneto Ignition Systems



#20340
#20340-7

DC DIGITAL VOLT METER

- Range 6V-30V DC
- Illuminated Red Read-out
- Includes Faceplate and Hardware



#20600

DUAL USB CHARGER

- Dual USB with Weatherproof Cover
- Total: 3.1A (1A + 2.1A)
- Indicator Light
- Includes Faceplate and Hardware



#20601

DUAL USB WITH VOLTAGE METER

- Dual USB with Weatherproof Cover
- Total: 4.2A (2.1A + 2.1A)
- Range: 5V-30V DC
- Includes Faceplate and Hardware



#20602

DUAL USB CHARGER

- Dual USB with Weatherproof Cover
- Total: 3.1A (1A + 2.1A)



#20603

Our Battery Bolts Feature:

- Easy and Reliable Direct Connections to the Battery
- Studs Accommodate One or Several 3/8" Ring Terminals
- Excellent for Trailer Brake Controls and Other Accessories Requiring Direct Power

- Direct-to-Battery Power Circuits Help Reduce Noise in Stereo, Communication and Other Electronic Equipment
- All Models are Solid Brass

Don't see your dimension here? Let us design and build for you!

Battery Bolt Dimensions

Part #	Overall Length	Nominal Diameter	Coupler Thread	Battery Insert	Stud Thread	Stud Length
30300	1.590"	5/8" hex	3/8-16	.400"	3/8-16	.400"
30400	1.750"	5/8" hex	3/8-16	.400"	3/8-24	.680"
30500	1.832"	5/8" hex	3/8-16	.250"	3/8-16	.960"
30600	1.440"	1/2" hex	5/16-18F .70" deep	N/A	5/16-18	.400"

TOP POST BATTERIES:

Replaces nut on cable connector bolt. Keeps ring terminals away from corrosion at battery terminal.

TOP MOUNT BOLT AND NUT, STANDARD

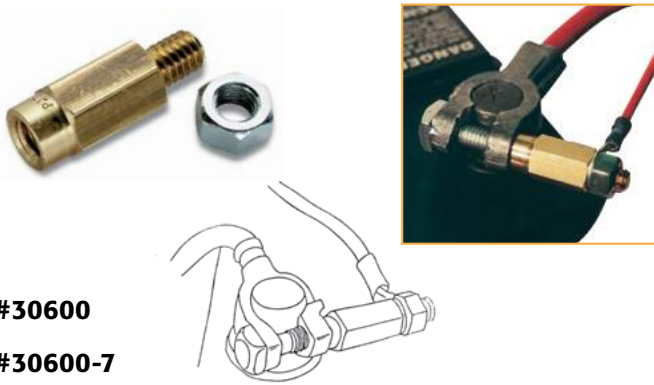

#30600
#30600-7

SIDE TERMINAL BATTERIES:

Replaces the standard bolt in the battery terminal with a threaded stud.

SIDE TERMINAL BOLT AND NUT, STANDARD

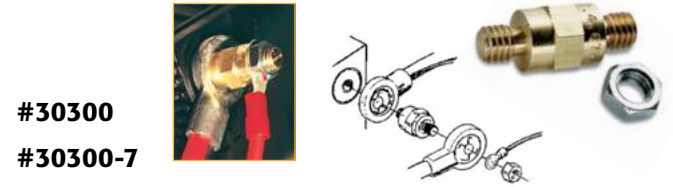

#30300
#30300-7

SIDE TERMINAL BOLT AND NUT, LONG

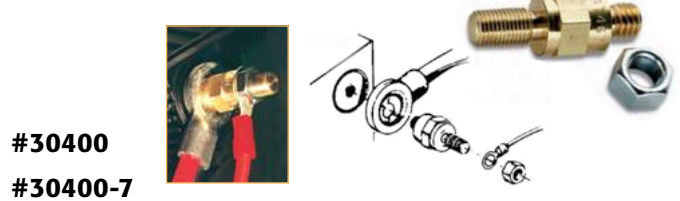

#30400
#30400-7

"DOUBLE CABLE" SIDE TERMINAL BOLT AND NUT, GM® TRUCK

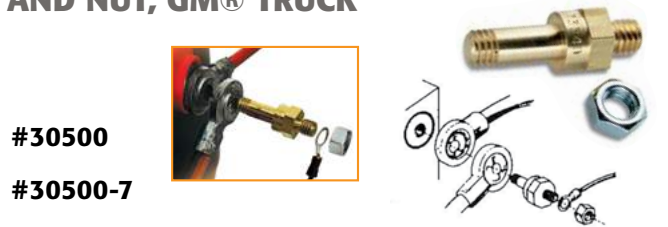

#30500
#30500-7

PATENTED FRAME GROUND TAP/SIDE MOUNT TERMINAL TAP

- Special Shape Allows Optional Attachment Directly to Battery Side Terminals
- Simple and Reliable Connection of Accessory Ground Leads
- Up to 3 Slip-On Terminals Can be Connected to Each Triple Tap
- Can be Stacked to Provide Multiple Taps at One Location

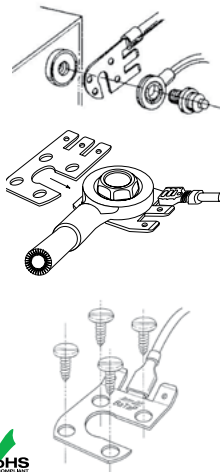

#30700 Kit – 2 Taps, 6 Slip-On Terminals

#30700-7 – Tap Only



PATENTED TAP TERMINAL/GROUND TAP

- Attaches to Top Post Cable Bolt without Removing Bolt
- Incorporates One #8 Hole for Optional Use as Frame Ground

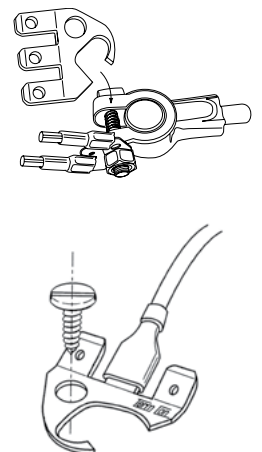

#30703 Kit – 2 Taps, 6 Slip-On Terminals

#30703-7 – Tap Only

CIRCUIT PROTECTION

FUSE TAPS FOR OCCUPIED SLOTS IN FUSE BLOCK

- Taps Clip onto Existing Fuses to Provide an Additional Connection Point for Slip-On Terminals
- A Tap Installed at "Cold" End of Fuse Slot is Protected by Existing Fuse
- A Tap Installed at "Hot" End of Fuse Slot Requires Installation of Additional In-Line Fuse for New Circuit

FUSE TAPS FOR ATO/ATC BLADE FUSES



#30001 Kit:
3 Taps, 6 Slip-On
Terminals

#30001-7
Tap Only

#30001-50

PATENTED FUSE TAPS FOR ATM/MINI-BLADE FUSES



#30800 Kit:
3 Taps, 6 Slip-On
Terminals

#30800-7
Tap Only

#30800-50

FUSE TAPS FOR AGC ROUND GLASS FUSES



#30200 Kit:
3 Taps, 6 Slip-On
Terminals

#30200-7
Tap Only

TAPS FOR VACANT ENERGIZED SLOTS IN ATM/MINI-FUSE BLOCK

- Provides tap for connecting slip-on terminal
- Requires installation of in-line fuse for new circuit



#30100 Kit:
3 Taps, 6 Slip-On
Terminals

#30100-7
Tap Only

42 PIECE FUSE KITS

Includes 7 pieces of each: 5, 10, 15, 20, 25, 30 Amp fuses.
Also includes fuse puller/tester.

42 PC FUSE KIT WITH PULLER/TESTER



#30914 Shown

#30914 – MidBlade™
(ATO/ATC Kit)

#30916 – Low Profile Mini
(APS Kit)

#30915 – MinBlade™
(ATM/Mini Kit)

#30917 – MinBlade™
(ATR/MICRO2™)

80 PIECE FUSE KIT

- Includes 10 Pieces Each:
3, 5, 7.5, 10, 15, 20, 25 and 30
Amp Fuses



#30990 – MidBlade™
(ATO/ATC Kit)

#30993 – MinBlade™
(ATM/Mini Kit)

6 PIECE FUSE KIT

- Includes 1 Piece Each:
5, 7.5, 10, 20, 25 and 30 Amp Fuses



- #30903 – MidBlade™ (ATO/ATC Kit)
- #30913 – MinBlade™ (ATM/Mini Kit)



MIDBLADE™ FUSES

- Replaces ATO/ATC Fuses
- Complies with SAE J1284 and UL 275A Standards

5 Pcs Retail Clam	50 Pcs Poly Bag	Bulk	Amp	Color
24353	24353-50	24353-7	3	Violet
24355	24355-50	24355-7	5	Tan
24357	24357-50	24357-7	7.5	Brown
24360	24360-50	24360-7	10	Red
24365	24365-50	24365-7	15	Blue
24370	24370-50	24370-7	20	Yellow
24375	24375-50	24375-7	25	Natural
24380	24380-50	24380-7	30	Green
24390	24390-50	24390-7	40	Orange



YELLOW TOOL BOX FOR CUSTOM KITS

DON'T SEE A KIT THAT FITS YOUR NEEDS?

LET US CREATE ONE FOR YOU!



24 PIECE FUSE TAP KIT

- 12 Volt Power Connector Kit



#30995

Part #	Description	Qty
30001-7	Fuse Tap Kits for ATO/ATC Fuses	2
30200-7	Fuse Tap Kits for AGC and SFE Fuses	2
30300-7	Battery Bolt for Side Mount Terminal Batteries	2
30600-7	Battery Bolt for Top Post Batteries	2
30700-7	Frame Ground Tap, Also Used as a Side Terminal "Triple Tap"	2
30703-7	Top Post "Triple Tap", Also Used as a Frame Ground	2
30800-7	Fuse Tap Kits for ATM/Mini Fuses	2
30870-7	Blue Terminals for 16-14 Gauge Wires	4
30873-7	Red Terminals for 22-18 Gauge Wire	4
30876-7	Yellow Terminals for 12-10 Gauge Wires	2
Total Pieces		24

MINBLADE™ FUSES

- Replaces ATM/Mini Fuses
- Complies with SAE J2077 and UL 275A Standards

5 Pcs Retail Clam	50 Pcs Poly Bag	Bulk	Amp	Color
24101	24103-50	24103-7	3	Violet
24105	24105-50	24105-7	5	Tan
24107	24107-50	24107-7	7.5	Brown
24110	24110-50	24110-7	10	Red
24115	24115-50	24115-7	15	Blue
24120	24120-50	24120-7	20	Yellow
24125	24125-50	24125-7	25	Natural
24130	24130-50	24130-7	30	Green



MINBLADE²™ FUSES

- Replaces ATR/Micro2™ Fuses

5 Pcs Retail Clam	50 Pcs Poly Bag	Bulk	Amp	Color
24805	24805-50	24805-7	5	Tan
24807	24807-50	24807-7	7.5	Brown
24810	24810-50	24810-7	10	Red
24815	24815-50	24815-7	15	Blue
24820	24820-50	24820-7	20	Yellow
24825	24825-50	24825-7	25	Natural
24830	24830-50	24830-7	30	Green



LOW PROFILE FUSES

These new smaller, lower profile APS/Mini Fuses are used in newer vehicles and any place where space is limited (Toyota Aygo, Toyota Prius, Honda Civic, Vauxhall Corsa, Citroen or Peugeot and many others and new Ford vehicles!).



- Replaces APS/Low Profile Mini Fuses
- Complies with JASO Standards



5 Pcs Retail Clam	50 Pcs Poly Bag	Bulk	Amp	Color
24155	24155-50	24155-7	5	Tan
24157	24157-50	24157-7	7.5	Brown
24160	24160-50	24160-7	10	Red
24165	24165-50	24165-7	15	Blue
24170	24170-50	24170-7	20	Yellow
24175	24175-50	24175-7	25	Natural
24180	24180-50	24180-7	30	Green

GLASS FUSES

- Replaces AGC Fuses



AGC Style Fuses

5 Pcs Retail Clam	50 Pcs Poly Bag	Bulk	Amp
24600	24600-50	24600-7	1
24602	24602-50	24602-7	2
24604	24604-50	24604-7	4
24605	24605-50	24605-7	5
24607	24607-50	24607-7	7.5
24610	24610-50	24610-7	10
24615	24615-50	24615-7	15
24620	24620-50	24620-7	20
24625	24625-50	24625-7	25
24630	24630-50	24630-7	30



MAXBLADE™ FUSES

- Replaces MAXI Fuses



5 Pcs Retail Clam	10 Pcs Poly Bag	Amp	Color
24520	24520-10	20	Yellow
24530	24530-10	30	Green
24540	24540-10	40	Orange
24550	24550-10	50	Red
24560	24560-10	60	Blue

GLASS FUSES

- Replaces SFE Fuses



SFE Style Fuses

3 Pcs Retail Clam	50 Pcs Poly Bag	Bulk	Amp
24703	24703-50	24703-7	3
24706	24706-50	24706-7	6
24707	24707-50	24707-7	7.5
24709	24709-50	24709-7	9
24714	24714-50	24714-7	14
24720	24720-50	24720-7	20
24730	24730-50	24730-7	30



AUTOMOTIVE BLADE FUSE STYLES

- MidBlade™ Fuse (ATO/ATC)
- MinBlade™ Fuse (ATM/Mini)
- MinBlade™ Fuse (ATR/Micro™)



- Low Profile Fuse (APS)



- MaxBlade™ Fuse (Maxi)



GLASS FUSES

- Replaces AGU Fuses



AGU Style Fuses

5 Pcs Retail Clam	50 Pcs Poly Bag	Bulk	Amp
24631	24631-50	24631-7	15
24633	24633-50	24633-7	30
24640	24640-50	24640-7	40
24650	24650-50	24650-7	50
24660	24660-50	24660-7	60



What a BRILLIANT Fuse Idea™!



MIDBLADE™ – MINBLADE™ ILLUMINATING LED FUSES... FOR ALL 12 VOLT VEHICLES



These fuses do the thinking for you by lighting up when they burn out – "Glow when Blown!"

- Ideal for Automotive, Marine, Agricultural, RV and More!
- Save Time and Remove the Guesswork Searching for a Burned Out Fuse
- Ideal for those Hard to See Areas!
- Each Fuse is Color Coded to Indicate the Amperage
- All Feature an Enclosed Element to Prevent Shocks, Sparks and Corrosion
- Designed to OEM Specifications

MIDBLADE™ LED FUSES

#24400 – 5 Pack Assortment:
1 Each – 10, 15, 20,
25, 30A

#24403 – 10 Pack Assortment:
2 Each – 10, 15, 20,
25, 30A

Part #	50 Pcs.	Amps	Color
24303-7	24303-50	3	Purple
24305-7	24305-50	5	Amber
24307-7	24307-50	7.5	Brown
24310-7	24310-50	10	Red
24315-7	24315-50	15	Blue
24320-7	24320-50	20	Yellow
24325-7	24325-50	25	Clear
24330-7	24330-50	30	Green



Replaces ATO/ATC Fuses

MINBLADE™ LED FUSES

#24100 – 5 Pack Assortment:
1 Each – 10, 15, 20,
25, 30A

#24103 – 10 Pack Assortment:
2 Each – 10, 15, 20,
25, 30A

Part #	50 Pcs.	Amps	Color
24003-7	24003-50	3	Purple
24005-7	24005-50	5	Amber
24007-7	24007-50	7.5	Brown
24010-7	24010-50	10	Red
24015-7	24015-50	15	Blue
24020-7	24020-50	20	Yellow
24025-7	24025-50	25	Clear
24030-7	24030-50	30	Green



Replaces ATM/Mini Fuses

SELF STRIPPING ATO/ATC FUSE HOLDERS

- No Need to Strip Wire
- Rated to 40 Amps
- Fits 14 18 Gauge Wire
- Simply Insert Each Wire and Crimp the Holder Closed, then Insert Fuse to Complete the Circuit



#31855-7
#31855-50



Insert wire

(Fuse and lead wires not included)



Crimp closed



Insert Fuse!

SINGLE FUSE BLOCK FOR MAXI BLADE FUSES

- Rated 60 Amps Max
- Material:
 - Body: Nylon (UL Flame:94-0)
 - Terminal: Plated Brass
- Fuse Not Included



#31862-7



HEAVY DUTY MAXI FUSE HOLDER WITH COVER

- Rated 60 Amps Max
- 6" Loop Length with 8-Gauge Wire
- Fuse Not Included



#31860
#31860-7
#31860-10



FAST ACTING AUTOMOTIVE MidiDoc™ LIMITER FUSE

- For Use With #24226-7 or #24227-7 Fuse Blocks
- 30mm Center to Center Bolt-On
- Interrupting Rating: 1000A @ 32VDC
- Operating Temperature: -40°~125°C



Part #	Amps	Color
24215-7	50	Red
24218-7	80	Natural
24221-7	100	Blue
24225-7	150	Grey



FUSE BLOCK FOR MidiDoc™ LIMITER FUSES WITH PROTECTIVE COVER

- Use with MidiDoc™ Limiter Fuses
- Lexan Protective Cover Prevents Accidentally Touching Exposed Terminal Studs
- Voltage Rating: 32 VDC
- Rated 300A Max
- Phenolic Laminate, Flame Retardant Base



(Fuse not included)



#24227-7

MidiDoc™ FUSE HOLDER WITH REMOVABLE COVER

- Use with MidiDoc™ Limiter Fuse
- Rated 30A – 100A Max
- Voltage Rating: 32 VDC
- Includes 2 Eyelets for E-Z Hold Down Mounting
- Terminals: M5 Nickel Plated Steel – Threaded Studs with Hex Nuts
- Material
 - Base: PBT (UL flame: 94V-0)
 - Cover: Nylon (UL flame: 94V-0)



#24226-7

Battery Doctor® Fast Acting heavy duty fuse limiters are recommended for use with high power DC, golf carts, forklifts, marine and other large battery applications.

FAST ACTING OPEN LINK FUSE LIMITER

- For Use with #24228-7 Fuse Block
- Fast Acting Automotive/Marine Limiter
- Bakelite/Gold Plated Copper
- Interrupting Rating:
 - 1000A @ 32VDC
 - 1500A @250VAC
- Voltage Rating: 250VAC, 32VDC



Part #	Amps
80	24230-7
100	24233-7
150	24235-7
250	24242-7
300	24243-7



FUSE BLOCK FOR OPEN LINK STYLE FUSE LIMITERS WITH PROTECTIVE COVER

- Use with Fast Acting Fuse Limiters
- Not to Exceed 300 Amps
- 125VAC
- Material:
 - Base: Polyester Impact/Electrical – Black with Mineral and Glass Fiber Added ULR Cert #E40654
 - Cover: Polycarbonate UL 94V-0



#24228-7

ATO/ATC MIDBLADE™ TAPA CIRCUIT™ DUAL FUSE HOLDER

DESIGNED FOR USE WITH ISO 8820 ATO/ATC FUSES, SAE J1284-ATO/ATC FUSES, AND UL 275A STANDARD-ATO/ATC FUSES.

- Turns One Fuse Slot Into Two!
- Plugs into Occupied or Vacant Energized Fuse Block Slot
- Provides One Fuse Holder to Protect Existing Circuit and a Second Fuse Holder to Protect New Circuit
- 10 Amp Rating at 12 Volts
- 16-Gauge Wire for New Circuit is 5" Long; Includes Insulated Crimp-Type Coupler
- ATO/ATC MidBlade™ Fuse Not Included



For information on our Mini Fuse Tapa Circuit™ Fuse Holder #30103, please see page 33



#30003
#30003-7

IN-LINE ATO/ATC MIDBLADE™ FUSE HOLDER

- 30 Amp In-Line Fuse Holder for MidBlade™ Fuses with Water Resistant Cap
- 12-Gauge Wire
- Loop Length is 5 ½"
- 30 Amp Fuse Included



#31820
#31820-7
#31820-10

IN-LINE ATO/ATC MIDBLADE™ STACKABLE FUSE HOLDER

- 30 Amp In-Line ATO/ATC MidBlade™ Fuse Holder with Water Resistant Cover
- Loop Length: 5 ½", Overall 12-Gauge Wire is 11"
- 30 Amp Fuse Included

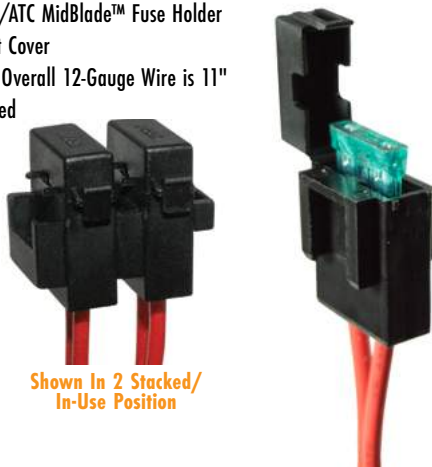

Shown In 2 Stacked/
In-Use Position



#31815-7

LED ATO/ATC MIDBLADE™ FUSE HOLDER WITH COVER

- Built-In LED for Identification of Blown Fuse
- 30 Amp In-Line ATO/ATC MidBlade™ Fuse Holder with 12-Gauge Wire and Water Resistant Cover
- 6" Wire Leads on Each Side for a Total Length of 12"
- 30 Amp Fuse Included



#24413
#24413-10



LED ATO/ATC MIDBLADE™ FUSE HOLDER

- Built-In LED for Identification of Blown Fuse
- 30 Amp In-Line ATO/ATC MidBlade™ Fuse Holder with 12-Gauge Wire
- 6" Wire Leads on Each Side for a Total Length of 12"
- 30 Amp Fuse Included



#24415-7

IN-LINE ATO/ATC MIDBLADE™ HEAVY DUTY FUSE HOLDER

- 30 Amp In-Line MidBlade™ Fuse Holder with 12-Gauge Wire
- 12" Loop Length
- 30 Amp ATO/ATC MidBlade™ Fuse Included

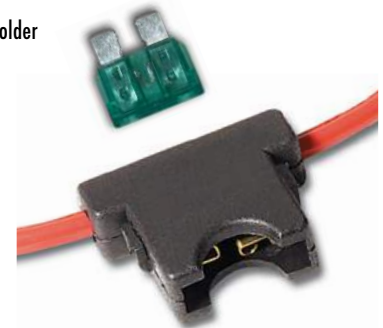

#31813
#31813-7
#31813-10



MEDIUM DUTY ATO/ATC MIDBLADE™ FUSE HOLDER

- Rated 20 Amps Max
- 12" Loop Length with 14-Gauge Wire
- ATO/ATC MidBlade™ Fuse Not Included



#31811
#31811-7
#31811-10

LIGHT DUTY ATO/ATC MIDBLADE™ FUSE HOLDER

- Rated 15 Amps Max
- 12" Loop Length with 16-Gauge Wire
- Fuse Not Included



#31816

#31816-7

#31816-10



WEATHERPROOF ATO/ATC MIDBLADE™ FUSE HOLDER

- Two 4" 12-Gauge Wire Leads
- Snap-On Cover Included
- Rated to 30 Amps

#31850

#31850-7

#31850-10



WATERPROOF IN-LINE GLASS FUSE HOLDER

- For AGC and SFE Glass Fuses
- Accepts 12-18 Gauge Wire
- Yellow Neoprene Material for Easy Visibility
- Rated 30 Amps Max
- Fuse Not Included



#31808

#31808-7



HEAVY DUTY IN-LINE GLASS FUSE HOLDER

Designed for Heavy Duty Applications Including Air Conditioners and Heater Blower Motors.

- 12-Gauge 8" Wire Loop for Easy Connection
- Uses Standard AGC and SFE Fuses
- Rated 30 Amps Max
- Fuse Not Included

#31802

#31802-7

#31802-10



UNIVERSAL IN-LINE ATO/ATC MIDBLADE™ FUSE HOLDER WITH COVER

- 30 Amp Fuse Holder
- Accepts 12-Gauge and Smaller Wire
- 30 Amp Fuse Included



#31840-7



UNIVERSAL IN-LINE GLASS FUSE HOLDER

- For AGC and SFE Glass Fuses
- "Snap-Lock" Provides Strong Positive Union of Fuse Holder Housing
- High Visibility Yellow
- Rated 30 Amps Max
- Accepts 12-18 Gauge Wire
- Nylon Fuse Holder for Normal Environments
- Simple Crimp Assembly
- Fuse Not Included



#31806

#31806-7



MEDIUM DUTY IN-LINE GLASS FUSE HOLDER

- 20 Amp In-Line Fuse Holder for AGC and SFE Fuses with 14-Gauge Wire
- Durable Locking Cap
- 8" Wire Loop
- Fuse Not Included



#31804

#31804-7



ATM/MINI MINBLADE™ FUSE TAPA CIRCUIT™ DUAL FUSE HOLDER

DESIGNED FOR USE WITH ISO 8820 FUSES, SAE J2077 FUSES, AND UL 275A STANDARD FUSES.

- Turns One Fuse Slot into Two!
- Plugs into Occupied or Vacant Energized Fuse Block Slot
- Provides One Fuse Holder to Protect Existing Circuit and a Second Fuse Holder to Protect New Circuit
- 10 Amp Rating at 12 Volts
- 16-Gauge Wire for New Circuit is 5" Long; Includes Insulated Crimp-Type Coupler
- Fuse Not Included



#30103

#30103-7

#30103-10  

IN-LINE ATM/MINI MINBLADE™ FUSE HOLDER WITH RING TERMINALS

- Contains 15 Amp Mini Fuse with Ring Terminals (3/8" Dia.) Attached to 3 1/4" Wire Leads
- Overall 16-Gauge Black Wire is 10 3/8"
- 15 Amp Fuse Included

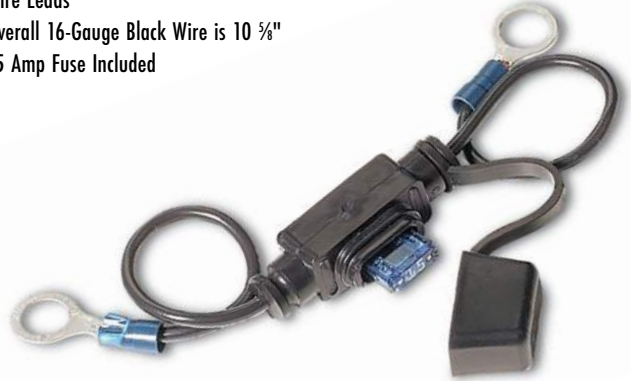

#20311-7

IN-LINE ATM MINBLADE™ STACKABLE MINI-FUSE HOLDER

- 30 Amp ATM/MinBlade™ Fuse Holder with 12-Gauge Wire
- Weather Resistant Cover
- 5 1/2" Wire Leads
- 30 Amp Fuse Included

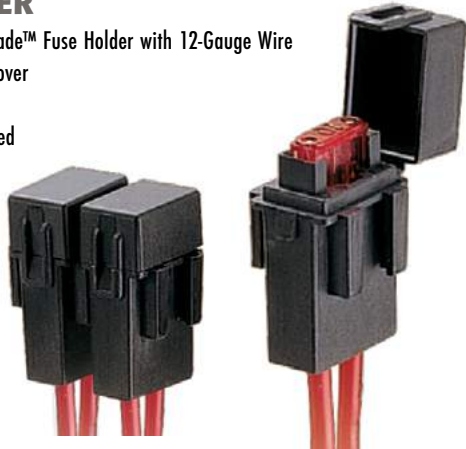

#31830-7

Shown in stacked/in-use position

IN-LINE ATM/MINI MINBLADE™ FUSE HOLDER WITH COVER

- 20 Amp In-Line ATM/MinBlade™ Fuse Holder with 16-Gauge Wire
- Water Resistant Cover
- Two 6" Wire Leads
- Fuse Not Included



#31827

#31827-7

#31827-10

LED ATM/MINI MINBLADE™ FUSE HOLDER WITH COVER

- Built-In LED for Identification of Blown Fuse
- 30 Amp In-Line ATM/MinBlade™ Fuse Holder with 12-Gauge Wire and Water Resistant Cover
- 6" Wire Leads on Each Side for a Total Length of 12"



#24410

#24410-7

#24410-10

WEATHERPROOF ATM/MINI MINBLADE™ FUSE HOLDER

- Rated 30 Amps Max
- 5" Wire Leads with 12-Gauge Wire
- Fuse Not Included



#31852-7

CIRCUIT PROTECTION

LOW PROFILE APS TAPA CIRCUIT™ DUAL FUSE HOLDER

- Turns One Fuse Slot into Two!
- Plugs into Occupied or Vacant Energized Fuse Block Slot
- Provides One Fuse Holder to Protect Existing Circuit and a Second Fuse Holder to Protect New Circuit
- Primary Circuit: 25 Amp Max Rating at 12 Volts
- Auxiliary Circuit: 15 Amp Max Rating at 12 Volts
- 16-Gauge Wire for New Circuit is 5" Long
- Use with APS Fuses
- Fuse Not Included

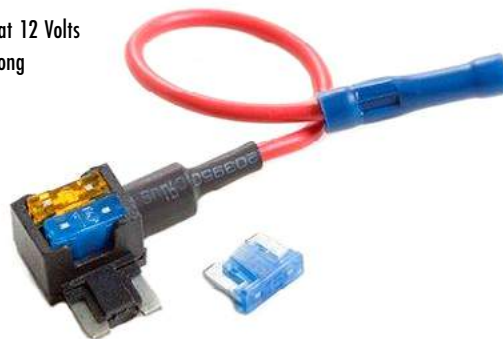

#30105

#30105-7

#30105-10



LOW PROFILE APS IN-LINE FUSE HOLDER WITH WATER RESISTANT COVER

- Rated 10 Amps Max
- 6" Wire Leads with 18-Gauge Wire
- Fuse Not Included



#30106-7

LOW PROFILE APS IN-LINE FUSE HOLDER WITH SPLASH PROOF COVER

- Rated 20 Amps Max
- 5" Wire Leads with 14 -Gauge Wire
- Fuse Not Included



#30104

#30104-7

MICRO² MINBLADE²™ TAPA CIRCUIT™ DUAL FUSE HOLDER

- Turns One Fuse Slot into Two!
- Plugs into Occupied or Vacant Energized Fuse Block Slot
- Provides One Fuse Holder to Protect Existing Circuit and a Second Fuse Holder to Protect New Circuit
- Primary Circuit: 25 Amp Max Rating at 12 Volts
- Auxiliary Circuit: 15 Amp Max Rating at 12 Volts
- 16-Gauge Wire for New Circuit is 5" Long
- Use with APT/Micro² Fuses
- Fuse Not Included



#30203

#30203-7

#30203-10

WIRE NUTS

- Rated to 300 Volt Max
- Make quick secure connections for positive continuity
- Reusable for easy circuit changes and addition

Part #	Gauge (AWG)	Quantity
80888	14-10	5
80889	14-10	100
80886	18-10	5
80887	18-10	100
80884	18-14	5
80890	18-14	100
80882	22-14	5
80883	22-14	100
80880	22-18	5
80881	22-18	100



ATO/ATC MIDBLADE™ FUSE BLOCKS

- 30 Amps Per Circuit at 12 Volt DC
- Blocks Accommodate 4 to 12 Fuses
- ATO/ATC Blade Fuse Holder for ¼" Slip-On Terminals
- Clear Acrylic Dust Cover with Bolt-Style Screw Included
- IP65 Rated-Dust Proof

Part #	Bulk	Description	A	B	C	D
30110	30110-7	4-Way Case	42mm	52mm	65mm	86mm
30111	30111-7	6-Way Case	42mm	52mm	93mm	116mm
-	30112-7	8-Way Case	42mm	52mm	130mm	153mm
-	30113-7	10-Way Case	42mm	52mm	158mm	163mm
-	30114-7	12-Way Case	42mm	52mm	188mm	210mm

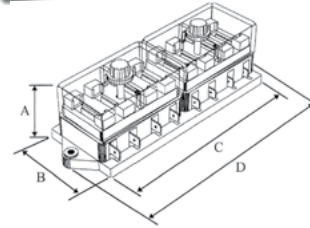

COMPACT ATO/ATC MIDBLADE™ AND ATM/MINI MINBLADE™ FUSE BLOCKS

- 30 Amps Per Circuit at 12 Volt DC
- Blocks Accommodate 4 to 10 Fuses
- Terminal Connector Slip-On
- Snap On/Off Clear Dust Cover

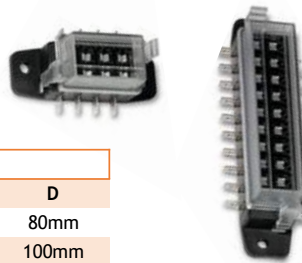

ATO/ATC MidBlade™					
Part #	Description	A	B	C	D
31000-7	4-Way Case	36.5mm	27mm	65mm	80mm
31003-7	6-Way Case	36.5mm	27mm	85mm	100mm
31005-7	8-Way Case	36.5mm	27mm	105mm	120mm
31007-7	10-Way Case	36.5mm	27mm	115mm	140mm

- ATM/MinBlade™ Fuse Holder for ¼" Slip-On Terminals
- 15 Amps Per Circuit at 12 Volt DC
- Includes Water Resistant Dust Cover with Rubber Seal
- Contact: Nickel Plated Copper Alloy
- Cover Material: Polycarbonate
- Base Material: Nylon UI 94V-0

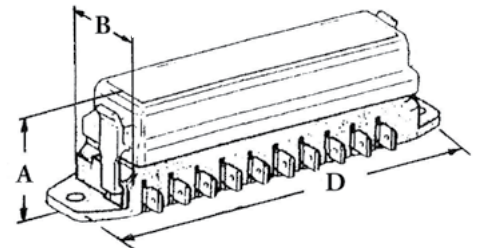
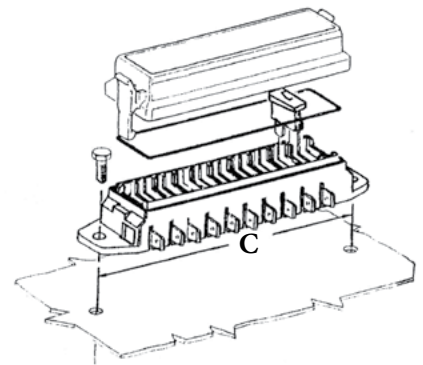

ATM/Mini MinBlade™					
Part #	Description	A	B	C	D
31010-7	4-Way Case	36.5mm	27mm	65mm	80mm
31013-7	6-Way Case	36.5mm	27mm	85mm	100mm
31015-7	8-Way Case	36.5mm	27mm	105mm	120mm
31017-7	10-Way Case	36.5mm	27mm	115mm	140mm



SINGLE LED FUSE ATO/ATC MIDBLADE™ HOLDER

- For Use with ATO/ATC Fuses Only
- LED Enclosed in Fuseholder, Glows When Fuse is Blown
- Includes Clear Dust Cover, Snaps into Base
- Rated: 12-24 Volt DC, 30 Amp Maximum
- Base: Nylon Body (UL Flame: 94V-2)
- Cover: Polycarbonate (UL Flame: 94V-2)



(Fuse not Included)

#30107

#30107-7



CIRCUIT PROTECTION

ATO/ATC MIDBLADE™ FUSE PANELS

Use with automotive fuses or plug-in circuit breakers. #10-32 stud terminal with hex nut, flat washer and lock washer supplied. Four .218" diameter mounting holes for #10 screws.

- Base: Polycarbonate
- Cover: Clear polycarbonate
- Maximum Amperage Per Circuit: 25 Amps
- Maximum Voltage: 32VDC
- Maximum Amperage Per Block: 150 Amps



ATO/ATC Fuse Panels		Product Dimensions				
Part #	Description	L	W	H	Common Ground	Dust Cover
31020-7	6-Way ATO/ATC Fuse Panel	3.36"	2.51"	0.83"		
31050-7	6-Way ATO/ATC Fuse Panel with Cover	3.36"	2.51"	1.10"		x
31030-7	6-Way ATO/ATC Fuse Panel with Common Ground	3.36"	2.51"	0.83"	x	
31060-7	6-Way ATO/ATC Fuse Panel with Common Ground and Cover	3.36"	2.51"	1.10"	x	x
31023-7	8-Way ATO/ATC Fuse Panel	3.36"	3.13"	0.83"		
31052-7	8-Way ATO/ATC Fuse Panel with Cover	3.36"	3.13"	1.10"		x
31033-7	8-Way ATO/ATC Fuse Panel with Common Ground	3.36"	3.13"	0.83"	x	
31062-7	8-Way ATO/ATC Fuse Panel with Common Ground and Cover	3.36"	3.13"	1.10"	x	x
31025-7	10-Way ATO/ATC Fuse Panel	3.36"	3.74"	0.83"		
31054-7	10-Way ATO/ATC Fuse Panel with Cover	3.36"	3.74"	1.10"		x
31027-7	12-Way ATO/ATC Fuse Panel	3.36"	4.39"	0.83"		
31056-7	12-Way ATO/ATC Fuse Panel with Cover	3.36"	4.39"	1.10"		x



ATO/ATC MIDBLADE™ & ATM/MINI MINBLADE™ FUSE PANELS

ATO/ATC Fuse Panels with LED Indicators and Cover		Product Dimensions		
Part #	Description	L	W	H
31074-7	4-Way ATO/ATC LED Fuse Panel	3.36"	1.85"	1.46"
31076-7	6-Way ATO/ATC LED Fuse Panel	3.36"	2.51"	1.46"
31080-7	10-Way ATO/ATC LED Fuse Panel	3.36"	3.74"	1.46"

ATM/Mini Fuse Panels with LED Indicators and Cover		Product Dimensions		
Part #	Description	L	W	H
31086-7	4-Way ATM/Mini LED Fuse Panel	3.35"	1.85"	1.46"
31087-7	6-Way ATM/Mini LED Fuse Panel	3.35"	2.48"	1.46"
31088-7	10-Way ATM/Mini LED Fuse Panel	3.35"	3.74"	1.46"

ATM/Mini Fuse Panels with Cover		Product Dimensions		
Part #	Description	L	W	H
31082-7	4-Way ATM/Mini Fuse Panel	3.35"	1.85"	1.46"
31083-7	6-Way ATM/Mini Fuse Panel	3.35"	2.48"	1.46"
31084-7	10-Way ATM/Mini Fuse Panel	3.35"	3.74"	1.46"

APS/Low Profile Mini Panels with Cover		Product Dimensions		
Part #	Description	L	W	H
31090-7	10-Way APS/Low Profile Mini Fuse Panel	3.35"	3.74"	1.46"
31091-7	10-Way APS/Low Profile Mini LED Fuse Panel	3.35"	3.74"	1.46"

- 1/4" Spade Quick Connects
- Lexan Dust Cover Included
- Base Material: Black Thermoplastic (UL Rated 94V-0)
- Maximum Current Rating: 30 Amps Per Circuit, 100 Amp Maximum Input

- LED Indicators Glow when Fuse is Blown (Open)

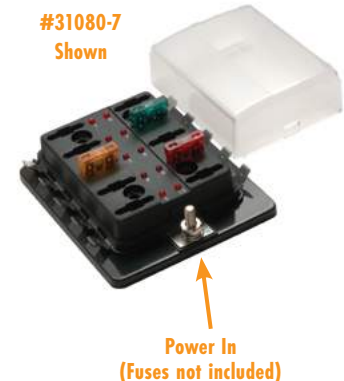

TYPE 1 BLADE STYLE AUTO RESET



Part #	Retail Pack	Amps
31180-7	31180	10
31181-7	31181	15
31182-7	31182	20
31183-7	31183	25
31184-7	31184	30

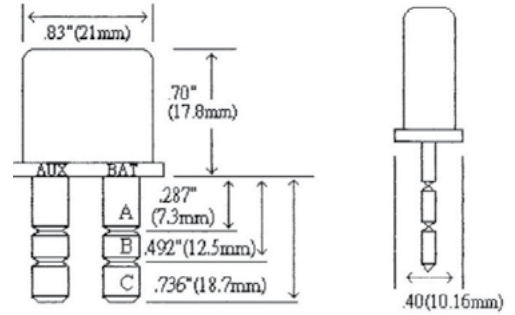

Measurements are in millimeters

TYPE 1 STUD MOUNTED



Part #	Amps
31101-7	10
31102-7	15
31103-7	20
31104-7	25
31105-7	30
31106-7	35
31107-7	40
31108-7	50

TYPE 1 STUD MOUNTED WITH RIGHT ANGLE BRACKET



Part #	Retail Pack	Amps
31110-7	—	8
31111-7	—	10
31112-7	31112	15
31113-7	31113	20
31114-7	—	25
31115-7	31115	30
31116-7	—	35
31117-7	31117	40
31118-7	31118	50

TYPE 1 STUD MOUNTED WITH IN-LINE BRACKET



Part #	Retail Pack	Amps
31121-7	31121	10
31122-7	31122	15
31123-7	31123	20
31124-7	—	25
31125-7	31125	30
31126-7	—	35
31127-7	—	40
31128-7	31128	50

All Circuit Breakers listed above comply with UL Standard

MANUAL RESET HEAVY DUTY CIRCUIT BREAKERS

- Water Resistant
- Panel or Surface Mounted
- Complies with SAE Standard J1625



Part #	Retail Pack	Amps
31201-7	31201	80
31202-7	31202	100
31203-7	—	120
31206-7	31206	150
31208-7	—	180
31209-7	—	200

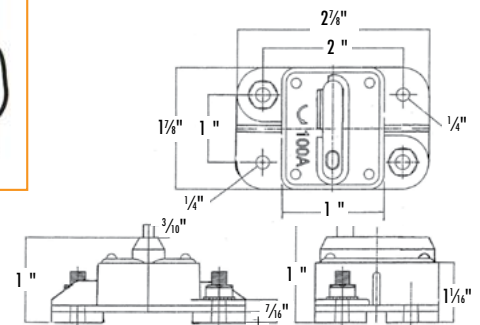
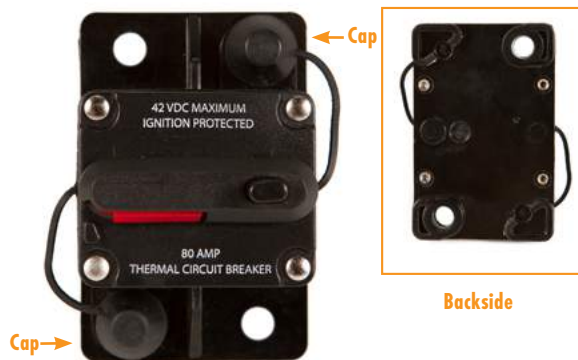

Measurements are in inches

TERMINALS

ALL BATTERY DOCTOR® TERMINALS COME IN A RESEALABLE BAG OR RETAIL CLAMSHELL



NYLON CRIMP CAPS

- High Temperature Nylon Insulation Rated to 221°F (105°C)
- Maximum Voltage: 600V



Part #	Gauge (AWG)	Quantity
80825	8	25
80822	12-10	5
80823	12-10	25
80820	16-14	5
80821	16-14	100
80224	22-14	100

MALE BULLET CONNECTORS

- Vinyl Insulation Rated to 167°F (75°C)
- Nylon Insulation Rated to 221°F (105°C)
- Maximum Voltage: 600V



Part #	Gauge (AWG)	Ins.	Quantity
80873	16-14	Nylon	5
80244	16-14	Vinyl	100
80246	22-18	Vinyl	100

NYLON FEMALE QUICK DISCONNECTS

- Fully Insulated Connectors for Optimum Protection
- High Temperature Nylon Insulation Rated to 221°F (105°C)
- Maximum Voltage: 300V



Part #	Gauge (AWG)	Tab Size	Quantity
80830	12-10	.250	5
80252	12-10	.250	100
80877	16-14	.250	5
80250	16-14	.250	100
80875	22-18	.250	5
80248	22-18	.250	100

NYLON MALE QUICK DISCONNECTS

- Fully Insulated Connectors for Optimum Protection
- High Temperature Nylon Insulation Rated to 221°F (105°C)
- Maximum Voltage: 300V



Part #	Gauge (AWG)	Quantity
80878	12-10	5
80258	12-10	100
80876	16-14	5
80256	16-14	100
80874	22-18	5
80254	22-18	100

NYLON BUTT CONNECTORS

- High Temperature Nylon Insulation Rated to 221°F (105°C)
- Maximum Voltage: 300V



Part #	Gauge (AWG)	Quantity
80807	12-10	25
80806	12-10	5
80211	12-10	100
80803	16-14	5
80804	16-14	25
80209	16-14	100
80800	22-18	5
80801	22-18	25
80207	22-18	100

VINYL FEMALE QUICK DISCONNECTS

- General Purpose Vinyl Insulation Rated to 167°F (75°C)
- Maximum Voltage: 300V



Part #	Gauge (AWG)	Tab Size	Quantity
80827	12-10	.250	25
80286	12-10	.250	100
80274	16-14	.110	100
80824	16-14	.187	25
80278	16-14	.187	100
80280	16-14	.205	100
80826	16-14	.250	25
80284	16-14	.250	100
80276	22-18	.187	100
80282	22-18	.250	100

VINYL MALE QUICK DISCONNECTS

- General Purpose Vinyl Insulation Rated to 167°F (75°C)
- Maximum Voltage: 300V



Part #	Gauge (AWG)	Tab Size	Quantity
80829	12-10	.250	25
80292	12-10	.250	100
80828	16-14	.250	25
80290	16-14	.250	100
80288	22-18	.250	100

VINYL BUTT CONNECTORS

- General Purpose Vinyl Insulation Rated to 167°F (75°C)
- Maximum Voltage: 300V



Part #	Gauge (AWG)	Quantity
80816	12-10	25
80217	12-10	100
80813	16-14	25
80215	16-14	100
80810	22-18	25
80213	22-18	100

VINYL RING TERMINALS

- General Purpose Vinyl Insulation Rated to 167°F (75°C)
- Maximum Voltage: 600V



Part #	Gauge (AWG)	Stud Size	Quantity
80334	12-10	#8	100
80857	12-10	1/4"	25
80346	12-10	1/4"	100
80859	12-10	5/16"	25
80350	12-10	5/16"	100
80359	12-10	3/8"	25
80357	12-10	3/8"	100
80332	16-14	#8	100
80845	16-14	#10	25
80338	16-14	#10	100
80847	16-14	1/4"	25
80344	16-14	1/4"	100
80849	16-14	5/16"	25
80851	16-14	3/8"	25
80354	16-14	3/8"	100
80328	22-18	#8	25
80330	22-18	#8	100
80840	22-18	#10	100



NYLON RING TERMINALS

- General Purpose Nylon Insulation Rated to 167°F (75°C)
- Maximum Voltage: 600V



Part #	Gauge (AWG)	Stud Size	Quantity
80863	12-10	#10	5
80864	12-10	1/4"	5
80865	12-10	5/16"	5
80852	16-14	#10	5
80853	16-14	1/4"	5
80854	16-14	5/16"	5
80843	22-18	#10	5

HEAT SHRINK BUTT CONNECTORS

- High Density Polyethylene Insulation Helps Keep Connection Dry
- Shrink Temperature: 302°F (150°C)
- Maximum Voltage: 600V



Part #	Gauge (AWG)	Quantity
80429	10-12	100
80428	16-14	100
80427	22-18	100

VINYL FORK/SPADE TERMINALS

- General Purpose Vinyl Insulation Rated to 167°F (75°C)
- Maximum Voltage: 600V

Part #	Gauge (AWG)	Stud Size	Quantity
80411	12-10	#6	100
80417	12-10	#8	100
80423	12-10	#10	100
80409	16-14	#6	100
80415	16-14	#8	25
80421	16-14	#8	100
80407	22-18	#10	100
80838	22-18	#6	100
80413	22-18	#8	100
80419	22-18	#10	100



SELF TAPPING IDC CONNECTORS

- Quick, reliable, and convenient splices
- No stripping, twisting, soldering, or special tools required
- Use with solid copper single-conductor wire



Part #	Gauge (AWG)	Quantity
80836	12-10	3
31870	12-10	50
80831	18-14	5
31877	18-14	50
80832	18-14	100

BATTERY ACCESSORIES

E2000 BLUE® PROFESSIONAL GRADE ANTI-CORROSION GEL

Professional grade anti-corrosion gel for battery posts, terminals, agricultural and marine equipment, wire connections, plugs, electrolysis protection, battery trays, nuts and bolts. Rust protection for old and new metal. Patented Microscopic Mineralization Process forms a barrier in the metal and changes the Ph to 10 or above, eliminating a place for corrosion to start.



#16201

#16204



#16214

Part #	Net. Wt.
16201	1 oz.
16204	4 oz.
16214	1/4 oz.

NYLON CLAMPS

- Stud size: #10
- Cable clamps are specially designed to hold cables, tubes, and components
- Allows you to easily mount bundles of cables to walls, ceilings, or any other surface



Part #	Size	Quantity
80867	3/16	25
80868	3/8	25
80869	1/2	25
80870	3/4	25

CABLE TIE ANCHOR

Fits 1/4" hole. Accepts all standard 1/8" wide cable ties. Just thread cable tie through slotted head. (Cable Tie Not Included)

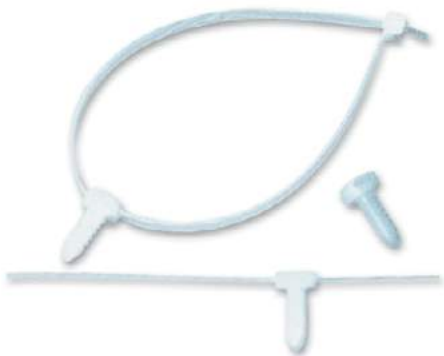

#75102

#75102-7

CABLE TIE MOUNT

- UV Resistant Nylon
- Includes Adhesive Backing
- 100 Pcs Poly Bag



#80170 – 1" Black

#80172 – 1" White

#80175 – 3/4" Black

UV CABLE TIES

- UV Resistant Nylon
- Ideal for Organizing Cables
- 100 Pcs Poly Bag



Part #	Length	Tensile	Color
80104	4"	18lbs	Black
80105	4"	18lbs	Natural
80106	7"	50lbs	Natural
80107	7"	50lbs	Black
80108	8"	40lbs	Black
80110	8"	40lbs	Natural
80111	11"	50lbs	Black
80112	11"	50lbs	Natural
80113	14"	50lbs	Natural
80114	14"	50lbs	Black
80115	14"	120lbs	Black
80116	14"	120lbs	Natural

HEAT SHRINK TUBING

- 2-1 Shrink Ratio
- 25' Length on Each Spool



Part #	Size	Color
80700	1/16"	Black
80702	1/8"	Black
80704	3/16"	Black
80706	1/4"	Black
80708	3/8"	Black
80710	1/2"	Black
80712	3/4"	Black
80714	1"	Black



UNIVERSAL TRAILER WIRE

- Universal 2-Pole Flat Connector
- 16" Leads with 18-Gauge Wire
- E-Z Connect Bullets



#20079

#20079-10



COMPLETE TRAILER CONNECTOR

- Male and Female Ends
- Color Coded 18 Gauge Wires
- 12" Long



#80900 – 3-Way Flat

#80901 – 4-Way Flat

4-WAY TOW VEHICLE END

- 4-Way Circuit Connectors for Female or Car End
- Standard RVI Color Code for Ease of Installation

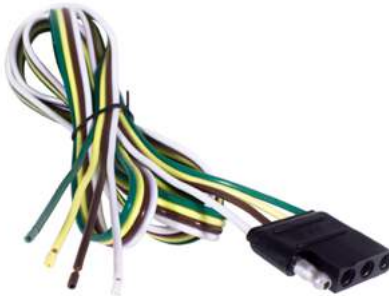

#80908 – 12" Pigtail Harness

#80909 – 48" Wishbone Harness

#80910 – 60" Bonded Harness

4-WAY TRAILER END

- Wishbone design for superior trailer harness
- Standard RVI color code
- Male plug



Part #	Length
80902	12"
80903	24"
80904	36"
80905	48"
80906	25'
80907	30'

7-WAY TO 4-WAY FLAT TRAILER ADAPTER

- Heavy Duty Blade
- Fits the Factory 7-way Plug on Most Trucks with a Tow Package
- Allows You to Tow Almost Any Trailer



#80915

7-WAY TRAILER PLUG COVER

- Prevents Bugs, Dirt, and Water from Damaging Trailer Plug
- Attaches to Trailer Plug for Convenience and Ease of Use
- Snaps to Cord when Plug is in Use
- See Page 47 for Retail Counter Display



#20081

#20081-7

7-WAY PLASTIC BLADE TYPE CONNECTOR PLUG AND TRAILER END

- Vinyl Inserts Keep Out Dirt and Moisture
- Features Dual Grips for Easy Removal



#80916

BATTERY ACCESSORIES

WATERBOY™ BATTERY FILLER

Battery Doctor® double action valve with shut-off nozzle stops the flow to prevent overfilling.

- Heavy Duty Injected Molded Body
- 2 Quart Capacity



#20420

WATERBOY™ BATTERY FILLER EXTENSION HOSE

- 24" Extended Hose Makes it Easy to Reach Tucked Away Batteries
- Easy to Assemble
- Fits Waterboy™ #20420
- Hose Only



#20425

Shown Fitted on #20420

BATTERY CLEANING BRUSH

- Heavy Duty Outer Metal Brush for Removing Corrosion and Rust from Posts and Terminals
- Inner Bristles Fit and Clean Standard Battery Posts
- Remove Cap to Reveal Brush
- Metal Case



(Metal Body)

#21000-7 – Metal Body

#21003-7 – Polymer Body

T-HANDLE BRUSH SIDE TERMINAL CLEANER

- Brush Easily Removes Rust and Corrosion from Side Terminals



(Polymer Body)

#21004-7

T-HANDLE BRUSH TOP POST PLASTIC BODY TERMINAL CLEANER

- Inner Brush Easily Removes Rust and Corrosion from Battery Posts



(Polymer Body)

#21006-7

BATTERY FLUID FILLER WITH FLEX BULB

- One Piece Construction Prevents Leaks at Bulb Area
- Acid Resistant
- Overall Length: 10"
- Material Made of SBR/PP



6" Spout

6oz. Capacity

#20410

CIRCUIT & SPARK PLUG TESTER

High quality tester instantly locates wiring problems such as bad connections, faulty or broken wires and sockets in 12 volt - 24 volt systems. A light will shine if the battery's condition is sound. No light will be visible if there is a short circuit or the battery is low.

- Overall Length: 8" with a Full 45" Lead Wire
- Includes Alligator Ground Clip, 3" Metal Probe with Cap



#21049



4-WAY TRAILER TEST LIGHT

- Helps to Properly Install a 4-Way Connector Without a Trailer Attached
- Plugs Into Your Existing Car-End Connector



#80911

SELF-ADJUSTING WIRE STRIPPER

- Strips and Cuts 10-26 AWG Wires
- Crimps Insulated and Uninsulated Terminals
- Strips Multi-Lead Trailer Wire without Harming Strands



#80920

ALL PURPOSE HAND TOOL

- For use with 22-10 AWG Wires
- Strips Wire and Crimps Terminals
- Features Wire and Bolt Cutters



#80921

J-TYPE BATTERY HOLD-DOWN BOLTS

Heavy duty tempered steel "J" bolts with wing nuts and protective rubber washers to attach battery to tray. Use with Replacement Trays #21085 or #21087 1/4" thread.

- 1/4" Threaded Rod on J-Bolts (Pair)



- #21060-7 – 8" J-Type
- #21063-7 – 10" J-Type



REPLACEMENT BATTERY TRAY

High quality replacement battery tray. Black vinyl-coated metal (16-gauge) battery tray provides a sturdy battery base. Coated to resist corrosion, rust and battery movement! Slotted drain holes eliminate moisture build up and condensation.

- #21085 – Small Tray (11" x 7" x 1") for Group 24 Batteries
- #21087 – Large Tray (13" x 7" x 1") for Group 27-31 Batteries



UNIVERSAL ADJUSTABLE BATTERY HOLD-DOWN

Fits the top of any Group Battery! Battery Doctor® hold-down secures the battery to the small or large "Replacement Battery Tray" (sold separately). Adjustable to size. Our corrosion resistant vinyl-coated low carbon steel hold-down comes with two 8 1/2" "J" steel bolts and wing nuts for securing the hold-down to the battery and thus the battery to the bottom tray (sold separately). 5/8" thread Fits battery width 4 1/2"-7".



- #21073-7

SIDE TERMINAL TO POST TERMINAL CONVERTERS

Converts side terminal batteries to accept top terminal battery cables and accessories. Die cast lead with zinc plated steel stud. Posts have 3/8" threaded stud to screw into side terminal batteries. Makes for easy charging with conventional charging equipment.

- #20253-7 – Positive and Negative Post Pair
- #20305-7 – Negative Post
- #20306-7 – Positive Post



UNIVERSAL SIDE TERMINAL BATTERY WRENCH

Designed for installing and removing OEM 5/16" side terminal bolts. Reversible ratcheting wrench features an easy grip handle. Fits all standard side mount bolts

- 5" Long



#21020

BATTERY TERMINAL MARKERS

Highly visible identification of terminals helps prevent damage to battery and alternator. 1" diameter, self-adhesive markers in red and black with large raised "+" and "-" symbols. Packaged in pairs of positive and negative.



E-Z Peel 'n Stick

- #20250
- #20250-7

BATTERY BRUSH

Plastic handled brush with two metal bristle brushes. Cleans side terminals and battery contacts. 5/16" hex in handle services GM connectors.



#21009-7

HARNESS WITH RING TERMINALS

- For Use with Battery Doctor® Chargers
- 15 Amp Fuse Protected
- 5/16" Eyelets
- 16 AWG
- 19.5" Long



- #20075
- #20075-7

ALLIGATOR CLIPS

- For Use with Battery Doctor® Chargers
- 16 AWG Wire
- 20" Long
- Plug and Play Bullet Connections



#20073-7

PRIMARY WIRE

PAIRED PRIMARY WIRE SPOOLS

- PVC Insulation Ideal for General Purpose Applications (-40°F to 167°F)
- Resistant to Grease, Oil, Gasoline, Acid, Solvents, Moisture and Aging

Part #	Gauge (AWG)	Color	Spool Length
80048	18	Red/Black	500'
80050	16	Red/Black	500'
80052	14	Red/Black	500'



CROSSLINK (GXL) PRIMARY WIRE

- XLPE Insulation is Made for High Temperature Applications (-59°F to 257°F)
- High Resistant to Grease, Oil, Gasoline, Acid, Solvents, Moisture and Aging
- High Resistance to Cuts and Abrasions
- Complies with SAE J1128

Gauge: 10 AWG		
81000	Black	100'
81001	Blue	100'
81002	Brown	100'
81003	Green	100'
81004	Orange	100'
81005	Red	100'
81006	White	100'
81007	Yellow	100'

Gauge: 14 AWG		
81015	Black	100'
81016	Blue	100'
81017	Brown	100'
81018	Green	100'
81019	Orange	100'
81020	Red	100'
81021	White	100'
81022	Yellow	100'
81023	Black	500'
81024	Blue	500'
81025	Brown	500'
81026	Green	500'
81027	Orange	500'
81028	Red	500'
81029	White	500'
81030	Yellow	500'

Gauge: 16 AWG		
81031	Black	100'
81032	Blue	100'
81033	Brown	100'
81034	Green	100'
81035	Orange	100'
81036	Red	100'
81037	White	100'
81038	Yellow	100'

Gauge: 12 AWG		
81008	Black	100'
81009	Blue	100'
81010	Brown	100'
81011	Green	100'
81012	Red	100'
81013	White	100'
81014	Yellow	100'

Gauge: 18 AWG		
81039	Black	100'
81040	Blue	100'
81041	Brown	100'
81042	Green	100'
81043	Red	100'
81044	White	100'
81045	Yellow	100'

PRIMARY WIRE

- PVC Insulation Ideal for General Purpose Applications (-40°F to 167°F)
- Resistant to Grease, Oil, Gasoline, Acid, Solvents, Moisture and Aging
- Complies with SAE J1128

Gauge: 8 AWG		
81046	Black	50'
81047	Red	50'

Gauge: 10 AWG		
80040	Black	100'
81048	Blue	100'
81049	Brown	100'
81050	Green	100'
81051	Orange	100'
80042	Red	100'
81052	White	100'
81053	Yellow	100'
81054	Black	500'
81055	Blue	500'
81056	Brown	500'
81057	Green	500'
81058	Red	500'
81059	White	500'
81060	Yellow	500'

Gauge: 12 AWG		
81061	Black	100'
81062	Blue	100'
81063	Brown	100'
81064	Green	100'
81065	Orange	100'
81066	Red	100'
81067	White	100'
81068	Yellow	100'
80036	Black	500'
81069	Blue	500'
81070	Brown	500'
81071	Green	500'
80038	Red	500'
81072	White	500'
81073	Yellow	500'

Gauge: 14 AWG		
81074	Black	100'
81075	Blue	100'
81076	Brown	100'
81077	Grey	100'
81078	Green	100'
81079	Orange	100'
81081	Pink	100'
81082	Purple	100'
81083	Red	100'
81084	Violet	100'
81085	White	100'
81086	Yellow	100'
80032	Black	500'
81087	Blue	500'
81088	Brown	500'
81089	Green	500'
80034	Red	500'
81090	White	500'
81091	Yellow	500'
81092	Blue	1000'
81093	Brown	1000'
81094	Green	1000'
81095	Red	1000'
81096	White	1000'
81097	Yellow	1000'

Gauge: 16 AWG		
81098	Black	100'
81099	Blue	100'
81100	Brown	100'
81101	Green	100'
81102	Orange	100'
81103	Red	100'
81104	White	100'
81105	Yellow	100'
80022	Black	500'
80020	Blue	500'
81106	Brown	500'
80024	Green	500'
80026	Red	500'
80028	White	500'
80030	Yellow	500'

Gauge: 18 AWG		
81107	Black	100'
81108	Blue	100'
81109	Brown	100'
81110	Green	100'
81111	Red	100'
81112	White	100'
81113	Yellow	100'
80002	Black	500'
80000	Blue	500'
80004	Brown	500'
80006	Green	500'
80008	Grey	500'
80010	Orange	500'
80012	Purple	500'
80014	Red	500'
80016	White	500'
80018	Yellow	500'

Gauge: 20 AWG		
81114	Black	100'
81115	Blue	100'
81116	Brown	100'
81117	Green	100'
81118	Red	100'
81119	White	100'
81120	Yellow	100'

Gauge: 22 AWG		
81121	Black	100'
81122	Blue	100'
81123	Brown	100'
81124	Green	100'
81125	Red	100'
81126	White	100'
81127	Yellow	100'

SPLIT LOOM TUBING

- Provides Excellent Protection to Cover Wire, Cables, Hoses and More!
- Gives Excellent Resistance to Gasoline, Oil and Other Corrosive Substances
- Made of Durable Polyethylene
- Operating Temperature -40°F to 200°F



#27030

Part #	Length	Description
27021	100'	1/4" Bulk Coil
27025	500'	1/4" Dispenser Box
27030	6'	3/8" Retail Pack
27032	50'	3/8" Bulk Coil
27031	100'	3/8" Bulk Coil
27033	300'	3/8" Dispenser Box
27050	4'	1/2" Retail Pack
27053	50'	1/2" Bulk Coil
27051	100'	1/2" Bulk Coil
27052	200'	1/2" Dispenser Box
27061	100'	5/8" Bulk Coil
27065	150'	5/8" Dispenser Box
27070	3'	3/4" Retail Pack
27071	100'	3/4" Bulk Coil
27075	100'	3/4" Dispenser Box
27100	100'	1" Bulk Coil
27110	100'	1" Dispenser Box



Dispenser Box

YOUR COMPLETE SOLAR, SMART CHARGER & 12 VOLT BATTERY SOLUTIONS DISPLAY

- 24 Popular Items, 47 Total Pieces

#23050



*Display Gondola Not Included

BATTERY DISCONNECT DISPLAY 4-PRONG RACK WITH "DEMO BATTERY"

Self-service display *PROMOTES SALES* by offering your customers a hands-on product demonstration.

Display Rack Includes:

- One Top Mount Battery Disconnect Switch (#20138)
- "Demo Battery"
- 4-Color Header Card
- Wire Rack: 11" W x 23" H x 8"

Easy To Assemble:

- Holds Up to 8 Battery Disconnect Switches
- Free Standing for Shelf or Counter
- Built-In Hooks Allow for Pegboard or Gondola Mounting



#20263

12 VOLT CIRCUIT PROTECTION DISPLAY

- 62 Items, 124 Total Pieces
- Fuses, Fuse Holders, and Circuit Breakers
- Display Rack Not Included

#23081



*Display Gondola Not Included

TRAILER PLUG COVER COUNTER DISPLAY

- 20 Trailer Plugs per Gallon Container



#20081-20

12 VOLT RV ELECTRICAL DISPLAY

- 124 Items, 248 Pieces Total
- Wide Variety of 12V Electrical Accessories
- Header Sign Included, Display Rack Not Included

#23080



*Display Gondola Not Included



*Display Gondola Not Included

12 VOLT FUSE & SWITCH SPECIALTY DISPLAY

- 91 Popular items, 179 Total pieces
- A Complete Planogram to Cover All the Needs for the Automotive Electrical Accessory Category

#23085

12 VOLT ACCESSORY POWER CONNECTOR SPECIALTY DISPLAY

- 23 Popular Items, 55 Total Pieces
- 14 1/2" W x 53" H x 4 1/2" D
- Free Standing Display, can be Mounted to Wall when Legs are Removed
- Gondola Mounting Hardware Included

#23020



12-VOLT OPERATING SWITCH/LIGHT DISPLAY BOX

- Full Working Display with 6 of the Most Popular Lighted Switches
- Can be Displayed on Slat Wall or Peg Board
- Designed to be Used with #23085 Display
- Promote Sales with Hands-On Product Demonstration



Part #	Description	Qty
	Power Supply	1
20500	Red Illuminated Toggle Switch	1
20521	Blue LED Metal Toggle Switch	1
20523	Red LED Metal Toggle Switch	1
20550	Red Illuminated On/Off Rocker Switch	1
20563	Chrome Aircraft Style Toggle Cover	1
20508	Heavy Duty Metal Toggle Cover Switch	1

#20580

LED WRITING BOARD

- Light Up Your Message with Neon Effect
- Easy to Write, Erase and Rewrite Your Message Over and Over
- Adjustable Modes (Color and Look)
- Durable, Portable and Energy Efficient
- How to Use: Write your message with included white fluorescent marker pen (1 included). Erase your message or drawing with included cloth. Use controller button to select color effect (red, blue, green), flash and speed.
- Dimensions: 15 3/4" x 11 3/4"
- Requires 110V Power
- Horizontal and Vertical Hanging Tabs Built In!



#23060



#23062 Adjustable Stand (Sold Separately)

DRUM FUNNELS

4-QUART DRUM FUNNEL

- Polypropylene
- Overall Height: 4 3/8"
- Top ID: 11 3/4"
- Thread: 2"
- Spout Length: 1 1/2"
- Spout OD: 2 1/2"

#32900 - With Screen

#32910 - Without Screen



4-QUART POLYPROPYLENE DRUM FUNNEL WITH LID

- Removable Filter Screen Included
- Lockable Top Lid
- Threads PPS Fitting for 2" Bung Hole
- 1 1/2" Bottom ID Opening
- Overall Height: 8"
- Spout Length: 1 3/8"
- Top ID 10"



#32425

DRAIN TOP FOR DRUM FUNNEL

- Polypropylene
- Top ID: 11 3/4"
- Drainage Lid Fits Our 4-Quart Drum Funnels #32900 and #32910 or Standard Size 5-Gallon Pail
- Use to Drain Standard Quart Bottles



#32940

3-QUART POLYETHYLENE DRUM FUNNEL

- Overall Height: 9 3/16"
- Top ID: 7 1/2"
- Spout Length: 1 7/16"
- Max Temp: 250° F



- #32400 - 2" Thread
Spout ID: 1"
- #32410 - 1" Thread
Spout ID: 3/4"

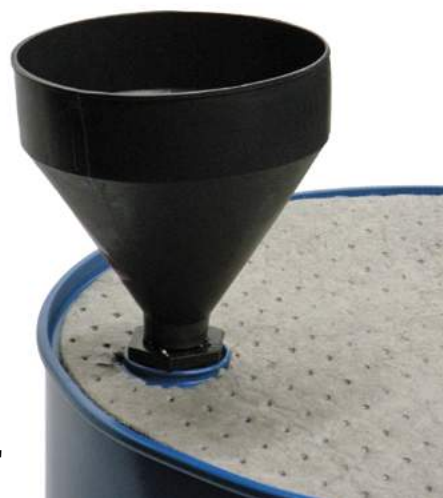

2-GALLON E-Z SMART DRUM FUNNEL

Smart Funnel Prevents Overfilling of Barrels

The Secret:

With the funnel extension, trapped air stops the liquid from filling to the top of the barrel. It leaves just enough room to add 2 gallons more to the barrel, which is the capacity of the E-Z SMART DRUM FUNNEL.

In order for the Smart Funnel to work properly, it must be removed immediately when fluid no longer flows freely.

This means the drum is full and cannot take any more fluid.

- Polypropylene Body and Lid with Attached Cord
- Polyethylene Air Hose and Band
- Overall Height: 13"

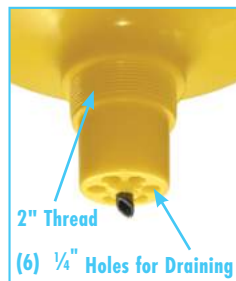

#32015

- Top OD with Cover: 11 1/2"
- Top ID: 11"
- Thread: 2"



POLYETHYLENE DRUM FUNNEL FOR OPEN OR CLOSED HEAD DRUMS

Direct hazardous materials into the drain of a drum with sloped channels designed to hold filters, bottles, funnels or other chemical containers. Fits 2" bung openings.

- Top ID: 21 1/2"
- Overall Height: 7"
- Spout ID: 1 1/2"
- Hole for Padlock
- Hinged Lid with Bolt and Nut Included

#32420



4-GALLON OIL DRAIN PAN INCLUDES E-Z GRIP HANDLES - BLACK

- Heavy Duty Polyethylene
- Top ID: 17 3/4"
- Spout OD: 1"
- Overall Height: 5 1/2"
- Use Black for Oil



#32953



6 1/2-QUART DRAIN BASIN

- Polypropylene
- Overall Length: 13 1/2"
- Top ID: 11 1/2"
- Height: 4 1/2"



#32950



4-GALLON COOLANT DRAIN PAN INCLUDES E-Z GRIP HANDLES - GREEN

- Heavy Duty Polyethylene
- Top ID: 17 3/4"
- Spout OD: 1"
- Overall Height: 5 1/2"
- Use Green for Coolant



#32955



INTERESTED IN RECYCLING OIL OR OTHER FLUIDS? COLLECT EVERY LAST DROP!

B.O.B.

"Bottom of the Bottle" oil bottle draining system

- Polypropylene
- 100% Post Industrial
- Save Money by using Every Last Drop of Oil
- Help the Environment by Keeping Motor Oil out of Landfills
- Free Standing or Mounts to Wall
- Black Color Only
- Fits (5) Standard Size Quart Bottles Only (Not Included)

#32947



Wall Mounted Application



Free Standing Application

NON-SPARKING ALUMINUM DRUM WRENCH

- Easy to use Wrench for Opening Most 2" and 3/4" Drum Plugs
- Aluminum Die Cast Construction, Hardened and Tempered for Increased Strength



#32442



HEAVY DUTY GRADUATED MEASURING CONTAINERS

Heavy Duty Polypropylene Measuring Containers are Chemically Resistant, Spark-Proof, Dent-Proof, Rust-Proof and Boil-Proof (Up To 212° F)

Part #	Capacity	Diameter	Height
94020	87 oz. (2.5L)	6"	8"
94026	Similar to #94020 Except with Black 4" Spout		
94040	155oz. (4.5L)	6.5"	15"
94046	Similar to #94040 Except with Black 4" Spout		



Heavy Duty Filler Extension #32167-7
Works with #94026 & #94046
Pg. 59



- Molded Raised Letter Graduations in US, Metric and Imperial
- Translucent Material Keeps Contents Visible
- Big Grip Handle and Sturdy Non-Tip Base
- Ideal for Mixing Chemicals, Oil, Gas and Powders



INDUSTRIAL FLEX SPOUT MEASURERS

- Raised Measurements Molded on Side: Quarts and Liters
- Manufactured of Heavy Duty Polyethylene
- Removable Spout
- Flex Spouts All Have ID 3/8" and OD of 1/2"

Part #	Capacity	Diameter	Height	Spout Length
94200	1/2 Quart	3"	4"	11"
94210	1 Quart	3 1/2"	5 1/2"	11"
94220	2 Quart	4 1/4"	6 3/4"	13"
94230	3 Quart	5"	9 1/2"	13"
94240	5 Quart	6 3/4"	11 3/4"	13"



#94200 #94210 #94220 #94230 #94240
1/2 Qt. 1 Qt. 2 Qt. 3 Qt. 5 Qt.

GENERAL PURPOSE GRADUATED MEASURING CONTAINERS

Chemically Resistant Polypropylene Measurers

Part #	Capacity	Diameter	Height
94100	3.4 Fl. oz.	2 1/8"	2 3/4"
94110	8.4 Fl. oz.	2 5/8"	4 3/4"
94120	17 Fl. oz.	3 1/2"	5 3/8"
94130	1 Quart	4 5/8"	6 3/4"
94140	2 Quart	5 1/2"	8 1/2"
94150	3 Quart	6 1/2"	9 1/2"
94160	5 Quart	8 1/8"	10 5/8"

- Easy-to-Read US and Metric Graduations Printed in Blue
- Translucent for Easy and Accurate Measuring
- #94110 - #94160 have Strong Reinforced Handle



#94100
100 mL



#94110 - #94160

TRANSLUCENT HIGH DENSITY GRADUATED MEASURING CONTAINERS

- Polyethylene Heavy Duty Construction
- Raised Quart and Liter Measurements
- Large Extended Screw-On Flexible Spout with Cap for Easy Pouring
- Screw Cap Keeps Debris Out

Part #	Capacity	Diameter	Height	Spout Length
94360	1 Quart	4 1/2"	6 3/4"	8"
94363	2 Quart	5"	8 3/4"	8 1/4"
94365	3 Quart	6"	10"	8 1/4"
94367	5 Quart	8"	11 1/4"	12"



#94367 - 5 Qt.
#94365 - 3 Qt.
#94363 - 2 Qt.
#94360 - 1 Qt.

1-QUART E-Z MEASUREMENT FUNNEL

- Measurements on Both Sides to Allow Fluid to be Measured when Funnel is Upright or Inverted
- Translucent for Easy and Accurate Measuring
- Caps Eliminate Spills and Contaminants
- Removable Spout for Easy Measuring and Pouring!
- Clean Fluids Help Prevent Mechanical Damage
- Chemically Resistant Polyethylene
- Overall Length: 13 3/4"



#32107

HIGH DENSITY POLYETHYLENE PITCHER

- Longer Gradual Sloping Spout for Hard to Reach Areas
- Two Handles Makes Pouring Easier
- Raised Quart and Liter Measurements
- Gas and Oil Compatible
- Pour Spout ID 1/2"

#32377
8 Quart

#32375
4 Quart



Part #	Capacity	Diameter	Height	Spout Length
32375	4 Quart	11 1/2"	13"	11 3/4"
32377	8 Quart	13"	15"	13 1/2"

17-QUART (4.25 GALLON) MONSTER FUNNEL

- Heavy Duty Polyethylene
- Overall Length: 14"
- Top ID: 13"
- Spout Length: 2 1/2"
- Spout OD: 1 1/8"



#32017

THE PROP'R MEASURE "TIP & MEASURE" CONTAINER

Patented 2-in-1 measuring and storage container. 16-oz. storage capacity that accurately measures 1-6 ounces before pouring. Chemically resistant polyethylene.

- Translucent For Easy And Accurate Measuring
- Heavy Duty
- Reusable
- FDA/USDA Approved



1. Tip to pre-measure. 2. Tip back to adjust. 3. Remove cap and pour. 4. Replace cap and store.

#72300

FLUID CONTROL

TRANSMISSION FUNNELS WITH FLEX SPOUT

- Designed for Transmissions, Drive Casings or Other Hard to get to Filler Openings
- Comes with 50 Grit Mesh Removable Brass Strainer Screen
- Fixed-On Flex Spout with Tapered Ends

ID 7/16"

#94460



Mesh Screen

ID 1/2"

#94492



Part #	Capacity	Height	Top OD	Spout ID	Spout Length
94460	1 Quart	7 3/8"	6 3/8"	7/16"	14"
94492	2 Quart	28"	7"	1/2"	17"

GALVANIZED MEASURE CAN WITH FLEX SPOUTS

- Heavy Duty Galvanized Steel with Hand Grip
- Splash-Resistant Tops
- Long-Reach Fixed-On Flexible Spouts with Tapered Ends

Part #	Capacity	Height	Spout Length
94484	1 Quart	6"	7 1/2"
94486	2 Quart	9"	7 1/2"
94488	4 Quart	11"	7 1/2"



#94484

#94486

#94488

BLACK MEASURING CONTAINER WITH FLEX SPOUT AND THUMB-OPERATED VALVE

- Heavy Duty Galvanized Steel with Hand Grip
- Flexible Fixed-On Spouts with Tapered Spout Opening 1/2" and 14" Length
- Thumb Operated Valve Controls Flow
- Flip Action Valve Locks Valve Open

Thumb-Operated Valve

Clip for Storing Spout in Upright Position

Part #	Capacity
94494	4 Quart
94496	5 Quart
94498	8 Quart



#94494

#94496

#94498

GENERAL PURPOSE UTILITY FUNNELS

- Galvanized Steel
- Includes Removable Filter 50 Grit Mesh Screen
- Ribbed Spouts to Allow for Venting

#94471



#94473



#94477



Part #	Capacity	Height	Top OD	Spout ID	Spout Length
94471	1 Quart	7 3/8"	6 3/8"	1/2"	3 1/8"
94473	2 Quart	7 3/4"	8 3/8"	1/2"	3 1/8"
94477	4 Quart	9 1/2"	12 3/8"	1"	3 3/4"

Mesh Screen



"Non-Swirl" Design Promotes Rapid Flow

HEAVY DUTY GALVANIZED FUNNELS

- Heavy Duty Galvanized Steel
- Includes Removable Filter 50 Grit Mesh Screen

Part #	Description	Capacity	Height	Top OD	Spout ID
94463	Galvanized Steel Funnel	8 Quart	11 7/8"	9 5/8"	1"
94462	Galvanized Steel "Body Rest" Funnel	8 Quart	11 7/8"	9 5/8"	1"
94464	Galvanized Steel "Lock-On" Funnel	8 Quart	11 7/8"	9 5/8"	1"
94467	Galvanized Steel Funnel	12 Quart	12 1/8"	11 3/8"	1"
94469	Galvanized Steel "Body Rest" Funnel	12 Quart	12 1/8"	11 3/8"	1"

Part #	Description	Capacity	Height	Top OD	Spout ID
94474	Galvanized Steel "Non-Swirl" Funnel	9 Quart	12"	12 1/2"	1"
94475	Galvanized Steel "Non-Swirl" Funnel	3 Quart	9 1/4"	8 1/2"	1/2"
94479	Galvanized Steel "Non-Swirl" Funnel	6 Quart	10 1/2"	10 1/2"	1"

Part #	Description	Capacity	Height	Top OD	Spout Length	Spout ID
94465	Galvanized Steel Offset Funnel	6 Quart	11 5/8"	10 1/2"	3 3/4"	1"



#94463



#94469



#94479



#94465

DRIP PAN

- 17 1/2" x 25 3/4" x 1" Drip Pan
- Galvanized Steel
- Capacity: 6 Qt.



#94482

12 QT WATER PAIL

- Prime 26 Gauge Galvanized Steel
- Features Unique Triple Locking "Gordon Seam" which forms a Six Layer Side Security Seam
- 6 Gauge Steel Handle
- 11 Gauge Top Rim
- Top ID 11.5"
- 10" H



#94490

13 QT UTILITY DRIP PAN

- Heavy Duty Galvanized Steel
- Rugged Design
- 17 1/4" Diameter
- 3 3/4" Height



#94480

PUSH - STYLE GREASE GUNS

- These Compact Guns Get Grease into Tight Spaces
- The Piston-Style Construction Allows One-Handed Operation; Simply Hold the Barrel and Push Down to Dispense Grease (Not Included)
- #32990 Comes with Both Standard Hydraulic and Flush Style Couplers
- Plastic Barrel
- For Use with Grease Rated NLG12 and Lower

#32990 - OAL 8", 80 mL / 2 1/2 oz.

#32985 - Red Cap, One Coupler,
OAL 6 1/2", 65 mL/2 oz.



HAND TRANSFER PUMP

- For Use With: Antifreeze, Detergents, Petroleum, Fuels, Oil, Water and Other Mild Chemicals
- Also Can Be Used as an Air Pump for Tires and Balls Using the Supplied Air Nozzle Attachments

#32467



SIPHON PUMP

- For Use With: Antifreeze, Detergents, Petroleum, Fuels, Oil, Water and Other Mild Chemicals
- Lightweight and Compact Design Makes it Easy to Stow Away in a Vehicle



#32469

ECONOMY OIL CHANGING KIT

The Funnel King® Oil Changing Kit includes everything you need to change the oil or fluids in any engine-powered vehicle, maintenance equipment, or outdoor power sports machine.

- Includes: one 6.5 Qt Drain Pan, one Offset Oil Funnel, two pairs of Nitrite Gloves, one 15" x 18" Sorbent Pad, and four Shop Towels



#32920

DELUXE OIL CHANGING KIT

Perfect for vehicles with 6 Qt or larger reservoirs, the Funnel King® Deluxe Oil Changing Kit includes everything you need to change the oil or fluids in any engine-powered vehicle, maintenance equipment, or outdoor power sports machine.

- Includes one 4 Gallon Drain Pan, one 6 Qt Funnel (with microscreen to prevent contamination), one pair of Nitrite Gloves, one 15" x 18" Sorbent Pad, and eight Shop Towels



#32925

10 PACK FUNNEL ASSORTMENT

- Assortment of 10 of the Most Popular Funnels to Suit Almost Any Fluid Transfer and Fluid Management Application
- Includes One 2 QT Funnel, One 3-Pack Funnel Set, Two Clip-On Spouts, Two Flex Spouts, One 1 QT Flex Funnel, One 1 1/4 Qt. Double Capped Funnel
- Helps to Avoid Hazardous Spills
- Reduces the Potential for Fuel, Oil, and other Fluids from Contamination
- Perfect for any Garage or Shop
- Always have the Right Funnel for All Applications

#32850



1-QUART POLYETHYLENE FUNNEL & FLEXIBLE SPOUT

- 1 Quart Economy Funnel with Screen
- Funnel Height: 6 1/2"
- 10" Removable Flexible Spout
- Handle for Easy Pouring



See Page 61 for
More Details on
Spout #32187

#32825

POLYETHYLENE ECONOMY FUNNELS

- Includes Hand/Thumb Tab with Hang Hole for Storage



Part #	Capacity	Color	Top ID	Spout ID	Height	Spout Length
32833	8 oz.	Yellow	3 1/2"	5/16"	4 1/4"	1 1/8"
32831	1 Pint	Black	5 1/8"	1/2"	4 1/2"	1 1/2"
32820	2 Quart	Black	7"	1/2"	7"	2 1/2"
32835	Combo Kit (Includes all 3: 1/2 Pint, 1 Pint, and 2 Quart)					

#32833

#32831

#32820



1 PINT FUNNEL WITH 21" FLEXIBLE SPOUT

- Polypropylene Funnel
- Polyethylene Spout Tubing
- Hanging Tab/Thumb Tab
- 5" Top Opening
- 1/2" Bottom Spout ID Opening



#32832



18" LONG REACH POLYPROPYLENE FUNNEL: 1-QUART CAPACITY

- Hanging Tab
- 4" Top Opening
- 1/2" Bottom Spout ID Opening



#32500

MULTI-PURPOSE FUNNEL

The Funnel King® Oil Multi-Purpose Funnel is specifically designed to work on all cap-less gas tanks, like those found on newer Ford vehicles. The Multi-Purpose Funnel is also great for adding performance enhancing gasoline additives.

- Heavy Duty Polyethylene Construction
- Large Pour Spout Minimizes Drips
- 11" Long for Those Hard-to-Reach Areas
- Top ID: 3 1/2"
- Spout OD: 1 3/8"
- Overall Height: 11"



#32855



POLYETHYLENE FUNNELS

- Includes Hand/Thumb Hold Tab with Hang Hole for Storage

Red Part #	Capacity	Top ID	Spout OD	OA Height	Spout Length	Black Part #
32090	1-Pint	4 1/2"	1/2"	6 1/8"	2 1/4"	#32093
32091	Similar to #32090 Except with 50 Micron Screen					#32092
32001	2-Quart	6 1/2"	1 1/16"	8 1/2"	2 3/8"	#32004
32002	Similar to #32001 Except with 60 Micron Screen					#32003
32005	6-Quart	8 1/4"	1 5/16"	10 1/2"	1 5/8"	#32008
32006	Similar to #32005 Except with 60 Micron Screen					#32007



3-QUART GUZZLER SWIVEL SPOUT

- Polyethylene
- Overall Length: 12"
- Top ID: 7 1/2"
- Spout Length: 4 7/16"
- Spout OD: 3/8"

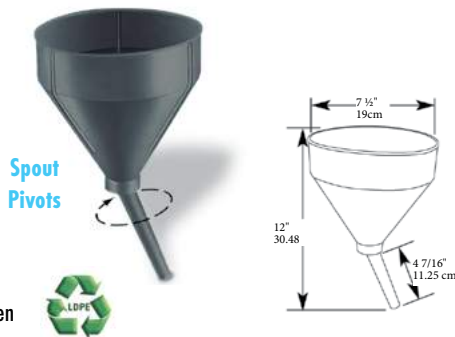

- #32301 - with Screen
- #32300 - without Screen

OFFSET LOCKING OIL FUNNEL

- Fits All Standard Quart Containers
- Holds Oil Containers in Place While Pouring
- Chemically Resistant
- Overall Length: 5 1/2"
- Spout Length: 1 3/4"
- Spout OD: 1 1/4"



#32847



DOUBLE CAPPED FUNNELS – "KEEPS THE DRIPS IN & THE DIRT OUT!"™ THE ULTIMATE "STORAGE" FUNNEL

- Caps Eliminate Spills and Contaminants
- Reduces Debris
- Clean Fluids Help Prevent Mechanical Damage
- Chemically Resistant Polyethylene



Part #	Capacity	Color	Top ID	Spout OD	Height
32105	1-Pint	Orange	3"	1/2"	8 3/4"
32115	1 1/4-Quart	Dark Blue	4"	3/4"	10 1/2"
32125	1 1/3-Quart	Black	4"	1 3/8"	16 1/2"
32130	1 1/2-Quart	Red	4"	1/2"	17 1/4"
32135	1 1/2-Quart	Yellow	4"	3/4"	14 1/4"
32140	1 1/2-Quart	Green	4"	1"	13 1/2"
32145	1 2/3-Quart	Dark Red	4"	1 3/8"	14 1/4"

HIGH DENSITY FAST FILL FUNNELS

Molded-In Screen to Keep Out Unwanted Debris.

- Clear Flexible Spout Makes Pouring More Accessible
- Molded-In Hand Grip for Easy Handling
- Large Spout Outlet Allows for Use with Powders



#94300
1 Qt.

#94310
2 Qt.

#94320
3 Qt.

Part #	Capacity	OA Height	Top ID	Spout OD	Spout Length	Flexible Spout OD
94300	1 Quart	16"	3 1/4"	1"	9 1/4"	3/4"
94310	2 Quart	15 1/4"	4 1/2"	1 1/16"	9 1/4"	3/4"
94320	4 Quart	21 1/2"	5 1/4"	1 7/16"	14"	1"

HEAVY DUTY POLYETHYLENE FUNNELS

WirthCo's lab and industrial funnels are sturdy and long lasting. Superior to ordinary funnels when quality and safety count.

- Chemically Resistant, Spark-Proof, Rust-Proof, Dent-Proof and Boil-Proof (Up to 212°)
- Translucent for Safer Accuracy
- Hanger Hole for Storage



Part #	Capacity	Color	Top ID	Spout OD	OA Height	Spout Length
95020	2 oz. (57mL)	Natural	2"	1/4"	2 1/2"	1/2"
95040	8 oz. (227 mL)	Natural	4"	1/2"	4 1/4"	1 1/8"
95050	14 oz. (398 mL)	Natural	5"	5/8"	5"	1 3/8"
95070	28 oz. (795 mL)	Natural	7"	5/8"	7 1/2"	2 3/8"

EXTRA HEAVY DUTY POLYETHYLENE FUNNELS

- Manufactured of White Virgin and Black Regrind Polyethylene
- Chemically Resistant, Spark-Proof, Dent and Boil-Proof (Up to 212°)
- Ideal for Lab and Industry
- Translucent for Accuracy and Safety
- Anti-Splash Rings Available on Two Models
- Removable Mesh 100 Grit (Fine) Filter Included with Each Funnel

Heavy Duty Filler Extension
#32167-7



Works with #90150

FUNNEL FILTER

Mesh, 100 grit (fine)

#90000-7

Works with all heavy duty polyethylene funnels in this section



#90190
144 oz.

#90090
144 oz.

#90092
144 oz.

#90150
24 oz.

#90080
120 oz.

Part #	Capacity	Color	Top ID	Spout OD	OA Height	Spout Length
90080	120 oz. (3.75 Ltr.)	Natural	7 3/8"	7/8"	15 1/2"	5 1/4"
90090	144 oz. (4.5 Ltr.)	Natural	8 1/8"	1 1/16"	10"	3 1/2"
90092	144 oz. (4.5 Ltr.)	Black	8 1/8"	1 1/16"	10"	3 1/2"
90150	24 oz. (.75 Ltr.)	Natural w/ Black Anti-Splash Ring	Splash Ring 3 1/4"	5/8"	6 1/8"	2 1/8"
90190	144 oz. (4.5 Ltr.)	Natural w/ Black Anti-Splash Ring	Splash Ring 6 5/8"	1 1/16"	10"	3 1/2"

ACCESSORIES

16 OZ. POLYPROPYLENE AUTO STOP™ FUNNEL

- Two Magnets Automatically Stops the Flow when Fluid Rises
- Pour-Off Spout
- Filter Screen
- 5" Top Opening
- Spout ID: 5/16"
- Spout OD: 1"

Prevent Dangerous Spills!

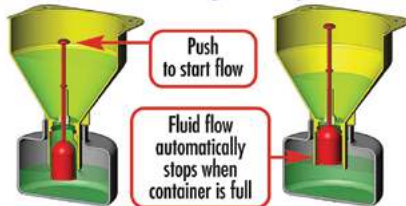

AVOID NASTY SPILLS



#32027

FOLDING POLYETHYLENE FUNNELS

- Save Storage Space
- Chemically Resistant
- Great for RV, Kitchen, Craft Projects or Anywhere Space is Limited



Model	Capacity	Color	Top ID	Spout OD	OA Height	Spout Length
32610	12 oz.	White	4 1/16"	1/2"	4 1/2"	1 1/16"
32700	16 oz.	Black	6 1/4"	1"	7"	1"
32701	Similar to #32700 Except with Stainless Steel Screen					



LONG LASTING HEAVY DUTY SCOOPS

Heavy Duty Polypropylene Scoops are Chemically Resistant, Spark-Proof and Rust-Proof

- Light Weight for Ease of Use
- Heavy Duty Secure Handles Do Not Conduct Heat



#93110
52 oz.

#93105
16 oz.

Part #	Capacity	Color	OA Length	Dimensions
93105	16 oz. (454 mL)	White	10"	6 1/2" L x 3 1/2" W x 2 1/2" H
93110	52 oz. (15 L)	Natural Translucent	12"	7" L x 5 1/2" W x 3 1/4" H



POLYPROPYLENE FUNNELS

- Outer Ribbing Eliminates Air Lock
- Custom Colors Available on Special Order



#32022



#32080



Specifications	Top ID	Spout ID	OA Height	Spout Length
2 Fl. oz.	2 3/8"	1/4"	2 5/8"	3/4"
4 Fl. oz.	3 1/8"	1/4"	3"	1"
8 Fl. oz.	3 3/4"	5/16"	4 3/4"	1 7/8"

Color	Black	Clear	Green	White
2 Fl. oz.	32020	32021	32023	32022
4 Fl. oz.	32040	Special Order	32041	32042
8 Fl. oz.	32078	Special Order	32080	32085

4 PACK POLYETHYLENE ECONOMY FUNNEL SET



#32837

Capacity	Color	Height	Top ID	Spout Length	Spout OD
3/4 Fl. oz.	Orange	3 1/8"	1 7/8"	1 5/8"	5/16"
2 Fl. oz.	Orange	4 1/2"	2 3/4"	2 1/4"	3/8"
6 Fl. oz.	Orange	5 3/4"	3 5/8"	2 5/8"	1/2"
10 Fl. oz.	Orange	6 1/4"	4 3/8"	3"	9/16"

E-Z FLOW™ POUR SPOUT

- Screws Onto Quart and Gallon Size Containers
- Includes Cap – Eliminates Unwanted Dripping
- Chemically Resistant
- Overall Length: 15 3/8"
- Spout OD: 1"
- Fits Standard Gallon 38mm Thread and 28mm Quart Thread
- Spout Length: 13 1/4"

#32177-7



E-Z FLOW™ SPOUT AND ADAPTER COMBO

#32179

E-Z FLOW™ SPOUT
#32177-7

SPOUT ADAPTER WITH GASKET

- Fits 2.5 Gallon, 63.5mm Threads

#32178-7



8 OZ. POLYETHYLENE FUNNEL WITH FIXED FUNNEL ADAPTER

- Stabilizes Funnel for Safe Filling Applications
- Vent Structure Eliminates Air-Lock
- Top ID: 4"
- Spout OD: 3/4", Fits Quart Bottles
- Spout OD: 1 1/8", Fits Gallon Bottles
- Height: 4"

#95855 - 8 oz. Funnel with Adapter



FLEX-O-SPOUT™ FLEXIBLE POLYETHYLENE POUR SPOUT

- Fits Most Gallon and Quart Containers
- 7" Spout Extends to 10.5"
- Bends to Any Angle
- Long Narrow Spout is Ideal for All Hard-to-Reach Areas

#32187



CLIP-ON SPOUT FOR QUART & GALLON CONTAINERS

Fits Quart

3/4" ID

Fits Gallon



Two sizes available, 2-in-1 or Gallon Size Only. Convenient to use; helps protect against spills and drips into engine compartment or work area. One side clips onto neck of plastic gallon container, other side clips onto neck of plastic quart container. Chemically resistant co-polymer polypropylene 2" L x 2" W, spout OD 3/8". Assorted colors.

#32257-7 – 2-in-1, Unpackaged

#32259-7 – Gallon Size Only Unpackaged

#32296 – 2-in-1, Clip Strip of 12 Units of #32251



#32251 – Clip Strip Packaging



#32255 – This Hang Hole Carded Package utilizes existing shelf/inventory space and requires no additional shelf space to display!



FLEXIBLE SPOUT FUNNEL – INCLUDES CAP

- Fits Gallon, Quart and Most Pint Containers



- Handles a Variety of Applications Including: Automotive/RV, Household, Lawn/Garden, Marine, Farm, Industrial and More
- Great for Chainsaws!
- Manufactured of Assorted Colors Thermoplastic Elastomer
- Temperature Rating: -57 Degrees – 250 Degrees F
- Spout OD: 1/2", 4" Long Spout

#32157 – Individual SKU

#32197 – 12 Units On A Clip Strip With Header Card (Custom Headers Available)



#32197



Recycle and Reuse!
Convert fluid containers into your own custom funnels.



Air-Tight "Closure Cap" Included!

MULTI-USE MAT BOOT TRAY

- Heavy Duty Polypropylene
- Unlimited Use in the Home, RV, Garage, Car, Trunk and Boat
- Protects Marine Craft and Trunks Against Gas/Oil Can Spills
- 25" L x 15" W x 3/4" D



#40098

BOOT TRAY

- Durable Polypropylene
- Economical
- 23" L x 15" W x 1/2" D



#40100

DRIP TRAY

- Made of Durable Polypropylene
- Resistant to Chemicals
- Excellent for Containing Spills and Drips from Machinery, Vehicles and Drums
- 22" W X 22" L X 1 1/2" D
- 2 Gallon Capacity



#40092

CHRISTMAS TREE & PLANTER TRAY

- Made of Durable Polypropylene
- Stabilizes Tree on Carpet
- Decorative Primary Green Color
- Protects Floors from Spills and Scratches
- 22" W x 22" L x 1 1/2" D



#40096

POLYPROPYLENE PLASTIC SQUEEGEE

- 8" Head with Scrub Material and Rubber Squeegee
- 18" Handle



#12115

THIRD HAND

Our "Third Hand" products provide an extra hand when and where it is needed, and allows easy positioning of blueprints, instructions, work lights, parts for assembly or welding and more.

- Flexible 18" Nickel Plated Arm that Stays in Place When You Bend it
- Rubber Tipped Steel Clamps Open to 2"



#10100

MACHINIST'S THIRD HAND

- Flexible 18" Nickel Plated Arm that Stays in Place When You Bend it
- Powerful Magnetic Base for Secure Mounting (Magnet Diameter: 3 3/8")
- Rubber Tipped Steel Clamp Opens To 2"



#10105

ISHY FISHY® SOAP DOPE CLEANSER

- All-Purpose Biodegradable Cleaning Agent
- Excellent for Fiberglass and Stainless Steel
- Cleans Everything from "Hands To Hulls"!
- Environmentally Safe
- Formulated with Pumice

A satisfied customer writes...

"We have a fishing boat that we clean with your product because it takes out the fuel and fish odors..."



#16010 – 4 oz. Squeeze Tube

THE TRUE & ONLY "LOCKING" RV BUMPER PLUG

Won't Fall Out!

- Securely Holds Sewer Hoses in Place
- Fits Standard 4" Bumper
- Push in Center to Lock
- No Drilling or Welding
- No Hinges
- Weather and UV Resistant
- Made of Thermoplastic Rubber

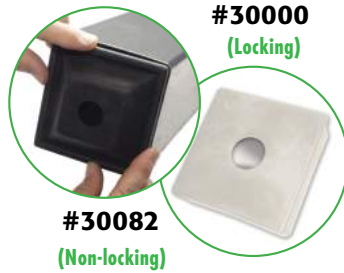

#30000
(Locking)

#30082
(Non-locking)

Part#	Description	Size	Material	Color
30000	RV "Locking" Bumper Plug	4"	Rubber	Black
30080	RV "Locking" Bumper Plug	4"	Rubber	White
30081-7	RV Bumper Plug	4"	Plastic	Black
30082-7	RV Bumper Plug	4"	Plastic	White

EXTRA HEAVY DUTY POLYPROPYLENE SHOVELS

Like a hand held snow plow!

- Push Blade
- Non-Sparking Wood Handle with "D" Grip
- Curved Blade: 20" W x 12" H
- Overall Length: 49"



#12105

D-GRIPS

- #12121** – 1 1/8" inside diameter
- #12123** – 1" inside diameter
- #12125** – 1 1/4" inside diameter



SAFETY SHIELD

- Sturdy Polycarbonate with Metal Sleeve
- Flexible 18" Nickel-Plated Arm that Stays in Place when Bent
- Powerful Magnetic Base for Secure Mounting (Magnet Diameter: 3 3/8")



- #10130** – Safety Shield with Magnet Mount
- #10135** – Safety Shield with Clamp Mount
- #10137** – Safety Shield Only

"BUMPIT™ BUMPERS"

Hollow-Back Thermoplastic Rubber Bumpers

- Prevent Damage to Docks, Industrial Equipment and Vehicles
- Impervious to Extreme Weather, Fresh/Salt Water and Atmospheric Deterioration
- 1/4" Mounting Hole Accepts 5/16" Carriage Bolt
- Counterbore Hole Diameter: 3/4"
- Temperature Range: -20° to +200° Fahrenheit
- Manufactured of Resilient, High Quality Thermoplastic Rubber more Flexible than Solid Rubber
- 70 Durometal Hardness



#77770
Red Reflector
Hole Inserts



#77777

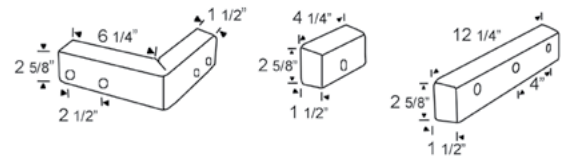

Specifications	Black Part #	White Part #
Straight: 4 1/4" x 2 5/8" x 1 1/2"	-	77776
Straight: 12 1/4" x 2 5/8" x 1 1/2"	77787	77777
Corner: 15" x 2 5/8" x 1 1/2"	77788	77797



KANGAROO™ TUFFSACK

Strong tear-resistant, UV-Treated vinyl bag with zipper closure holds up to 50 lbs. Slits cut on each end for easy carrying. Full width opening allows easy filling and emptying.

- 30" x 16"

#50500

It's splash resistant!

