

with Installation Instructions  
**Owner's Manual**

# **Banks Brake<sup>®</sup>**

***Compatible with Installed Six-Gun<sup>®</sup>  
Power Tuner with Six-Gun Switch***

**2006-2007 Chevy/GMC 6.6L (LLY-LBZ)  
Turbo-Diesel Pickup**

THIS MANUAL IS FOR USE WITH KITS 55448

**banks**

**Do not use this product until you have carefully read the following agreement.**

**This sets forth the terms and conditions for the use of this product. The installation of this product indicates that the BUYER has read and understands this agreement and accepts its terms and conditions.**

## **Disclaimer of Liability**

Gale Banks Engineering Inc., and its distributors, employees, and dealers (hereafter "**SELLER**") shall in no way be responsible for the product's proper use and service. The **BUYER** hereby waives all liability claims.

The **BUYER** acknowledges that he/she is not relying on the **SELLER's** skill or judgement to select or furnish goods suitable for any particular purpose and that there are no liabilities which extended beyond the description on the face hereof and the **BUYER** hereby waives all remedies or liabilities, expressed or implied, arising by law or otherwise, (including without any obligations of the **SELLER** with respect to fitness, merchantability, and consequential damages) whether or not occasioned by the **SELLER's** negligence.

The **BUYER** is responsible to fully understand the capability and limitations of his/her vehicle according to manufacturer specifications and agrees to hold the **SELLER** harmless from any damage resulting from the failure to adhere to such specifications. The **SELLER** disclaims any warranty and expressly disclaims any liability for personal injury or damages. The **BUYER** acknowledges and agrees

that the disclaimer of any liability for personal injury is a material term for this agreement and the **BUYER** agrees to indemnify the **SELLER** and to hold the **SELLER** harmless from any claim related to the item of the equipment purchased. Under no circumstances will the **SELLER** be liable for any damages or expenses by reason of the use or sale of any such equipment. The **BUYER** is responsible to obey all applicable federal, state, and local laws, statutes, and ordinances when operating his/her vehicle, and the **BUYER** agrees to hold the **SELLER** harmless from any violation thereof. The **SELLER** assumes no liability regarding the improper installation or misapplication of its products. It is the installer's responsibility to check for proper installation and if in doubt, contact the manufacturer. The **BUYER** is solely responsible for all warranty issues from the automotive manufacturer.

## **Limitation of Warranty**

Gale Banks Engineering Inc. (hereafter "**SELLER**"), gives Limited Warranty as to description, quality, merchantability, fitness for any particular purpose, productiveness, or any other matter of **SELLER's** product sold herewith. The **SELLER** shall be in no way responsible for the product's open use and service and the **BUYER** hereby waives all rights except those expressly written herein. This Warranty shall not be extended or varied except by written instrument signed by **SELLER** and **BUYER**.

Please see enclosed warranty information card, for warranty information regarding your product. Parts or devises outside the products kit, are not covered under Gale Banks Engineering warranty. All products that are in question of Warranty must be returned shipping prepaid to the **SELLER**

and must be accompanied by a dated proof of purchase receipt. All Warranty claims are subject to approval by Gale Banks Engineering Inc.

Under no circumstance shall the **SELLER** be liable for any labor charged or travel time incurred in diagnosis for defects, removal, or reinstallation of this product, or any other contingent expense.

Under no circumstances will the **SELLER** be liable for any damage or expenses incurred by reason of the use or sale of any such equipment.

**In the event that the buyer does not agree with this agreement:**

**The buyer may promptly return this product, in a new and unused condition, with a dated proof-of-purchase, to the place-of-purchase within thirty (30) days from date-of-purchase for a full refund, less shipping and/or restocking fee.**

**The installation of this product indicates that the buyer has read and understands this agreement and accepts its terms and conditions.**

## Table of Contents

<b>Also Available . . . . .</b>	<b>4</b>
<b>From Banks Power</b>	
<b>General Installation . . . . .</b>	<b>6</b>
<b>Practices</b>	
<b>Section 1 . . . . .</b>	<b>7</b>
Installation of Banks SpeedBrake Wire Harness	
<b>Section 2 . . . . .</b>	<b>17</b>
Installation of Banks Brake Switch	
<b>Section 3 . . . . .</b>	<b>20</b>
Banks Brake Operation	
<b>Section 4 . . . . .</b>	<b>21</b>
Banks Brake Troubleshooting	
<b>Section 5 . . . . .</b>	<b>24</b>
Placement of the Banks Power Decal	

# Products available From Banks Power for the 06-07 Chevy/GMC 6.6L

2006-2007 Chevy/GMC 6.6L LLY-LBZ



## **Banks iQ System (P/N 61141-61145)**

- 5" touchscreen interface that can control the Banks Diesel Tuner and/or SpeedBrake on the fly.
- Interchangeable gauge display, read and clear codes, monitor engine diagnostics, log data, time your vehicles runs and much more.

## **Banks Monster Exhaust System (P/N 48942-48946, 48937-48941 & 48772-48776)**

- Increases exhaust flow, cuts backpressure, lowers exhaust gas temperatures (EGTs) and increases power.

## **Banks Ram-Air Intake System (P/N 42142)**

- Increases your airflow over stock.
- Adds power, improves fuel economy, lowers EGTs and reduces smoke.

## **Banks Super-Scoop (P/N 42168-42169)**

- Adds cooler denser air to the Ram-Air Intake housing, further increasing fuel economy, reducing smoke and lowers EGTs.

## **Boost and Pyro Gauges (P/N 64507)**

- Keep your engine safe by monitoring vital engine parameters

**Big Hoss Intake Manifold System  
(P/N 42733)**

- Increases flow and provides more uniform air distribution to the engine for more available power at a given boost level.

**Banks Techni-Cooler System  
(P/N 25982)**

- Provides increased air flow to the engine by increasing air density for more increased power, lower EGTs and improved fuel economy.

**Banks SpeedBrake  
(P/N 55441 & 55443)**

- Allows for controlled hill decent at a user defined or preset vehicle speed.

**Banks Billet Torque Converter  
(P/N 72510)**

- Higher torque capacity over stock
- Lockup clutch is slip-resistant so transmission fluids stay cooler and transmission life is prolonged.

**Thermocouple**

- Add a temperature limiting function to your diesel tuner.

**Banks Speed-Loader  
(P/N 63718)**

- Furthers the power output of the Banks Six-Gun and provides EGT limiting safety.

**Banks Diesel Tuner  
(P/N 63863 EconoMind w/ Switch  
P/N 63857 EconoMind w/ iQ  
P/N 63867 Six-Gun w/ Switch  
P/N 63859 Six-Gun w/ iQ)**

- Adds power safely to your vehicle
- Engine and transmission safeguards
- Change power levels on-the-fly

**Banks PowerPack Systems  
(P/N 47773-47782)**

**Contains:**

- Ram-Air Intake system
- Monster Exhaust (single or duals)
- EconoMind Tuner w/ Banks iQ
- Technis-Cooler System

**Banks Stinger System  
(P/N 47763-47772)**

**Contains:**

- Ram-Air Intake System
- Monster Exhaust (single or dual)
- EconoMind Tuner w/ Banks iQ

**Banks Big Hoss Bundle  
(P/N 47753-47762)**

- Ram-Air Intake system
- Monster Exhaust (single or dual)
- Six-Gun Tuner w/ Banks iQ
- Techni-Cooler System

**Banks Six-Gun Bundle  
(P/N 47743-47752)**

- Ram-Air Intake system
- Monster Exhaust (single or dual)
- Six-Gun Tuner w/ Banks iQ

# General Installation Practices

- 1.** Before starting work, familiarize yourself with the installation procedure by reading all of the instructions.
- 2.** The exploded views provide only general guidance. Refer to each step and section diagram in this manual for proper instruction.
- 3.** Throughout this manual, the left side of the vehicle refers to the driver side, and the right side to the passenger side.
- 4.** Disconnect the negative (ground) cable from the battery (or batteries, if there are two) before beginning work.
- 5.** Route and tie wires and hoses a minimum of 6" away from exhaust heat, moving parts and sharp edges. Clearance of 8" or more is recommended where possible.
- 6.** When raising the vehicle, support it on properly weight-rated safety stands, ramps or a commercial hoist.

Follow the manufacturer's safety precautions. Take care to balance the vehicle to prevent it from slipping or falling. When using ramps, be sure the front wheels are centered squarely on the topsides. When raising the front of the vehicle, put the transmission in park (automatic) or reverse (manual), set the parking brake, and block the rear wheels. When raising the back of the vehicle, be sure the vehicle is on level ground and the front wheels are blocked securely.

**CAUTION: Do not use floor jacks to support the vehicle while working under it. Do not raise the vehicle onto concrete blocks, masonry or any other item not intended specifically for this use.**

**7.** During installation, keep the work area clean. Do not allow anything to be dropped into intake, exhaust, or lubrication system components while performing the installation, as foreign objects will cause immediate engine damage upon start-up.

**8.** Save this Installation Manual as a reference for system maintenance and service.

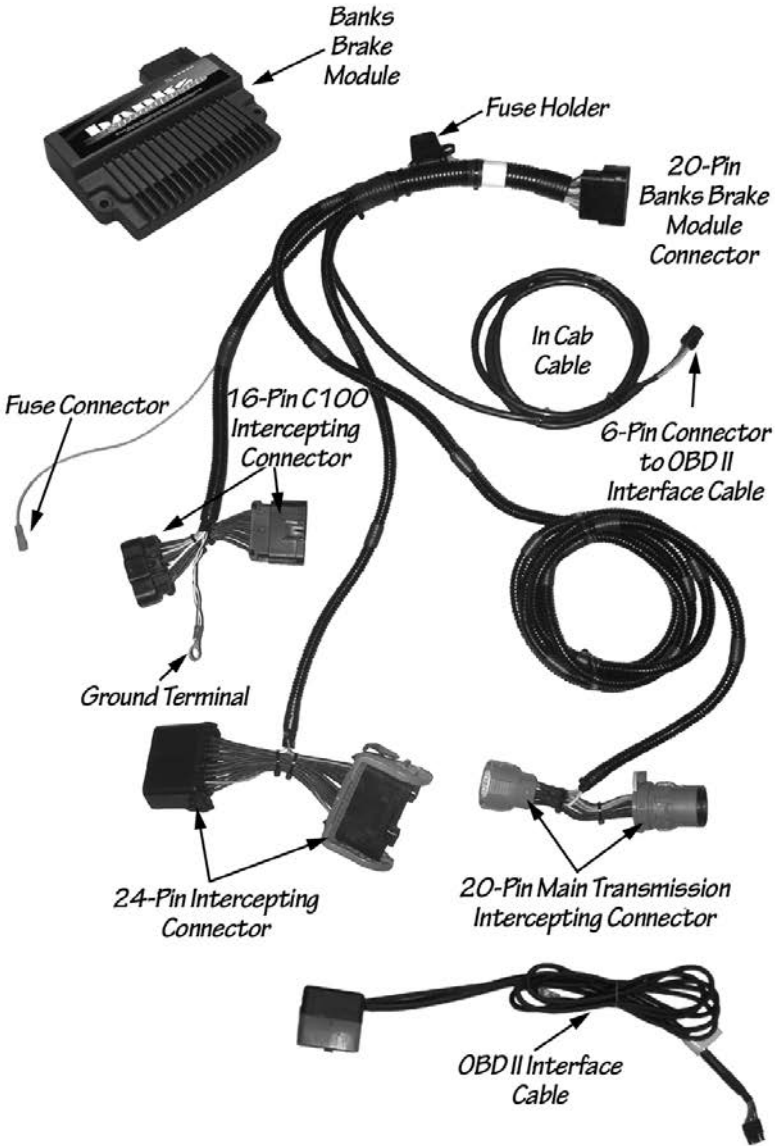
## TOOLS REQUIRED:

- 1/2" and 3/8" drive ratchets with inch and metric sockets and 1/2" and 3/8" drive extension
- Inch and metric combination or open-end wrenches
- Standard & Phillips screwdriver
- Clean shop towels or rags
- Pliers
- Needle nose pliers
- Utility knife
- Inch-pound and foot-pound torque ratchets

# Section 1

## INSTALLATION OF BANKS SPEEDBRAKE WIRE HARNESS

**Figure 1** Banks SpeedBrake and supplied wiring harness



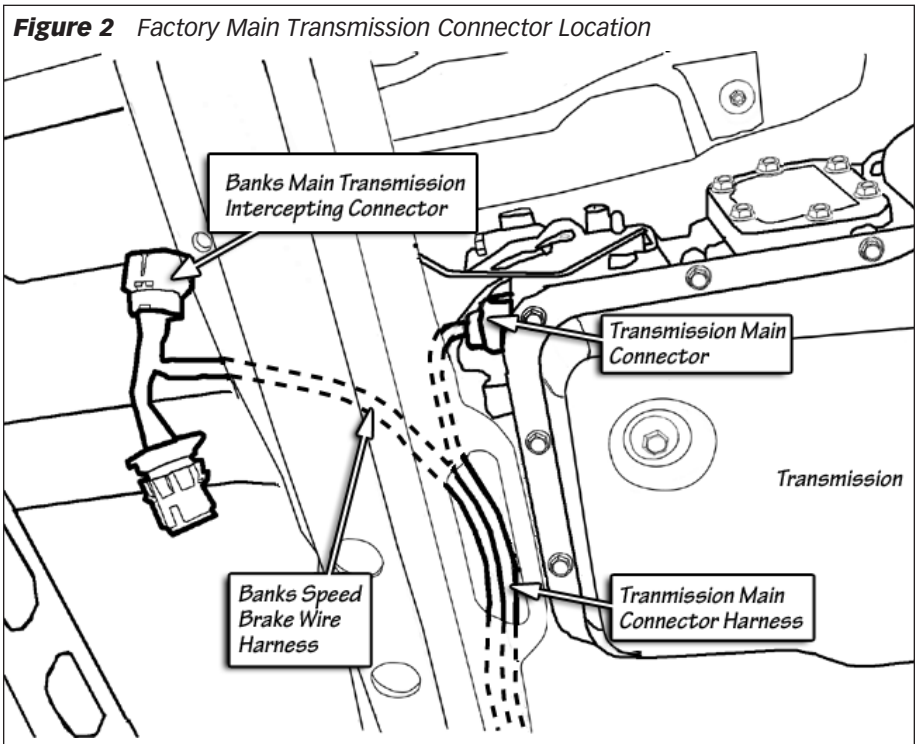
*NOTE: If you have purchased a combination Banks Brake/ Tuner Package, install the Tuner First and ignore the installation of the OBD II interface cable. After completing installation of the Tuner continue with this manual.*

- 1.** Disconnect the negative (ground) cable from the battery (or batteries, if there are two) before beginning work. Secure the cables so that they do not come in contact with the battery posts during the installation.
- 2.** Locate the Banks Brake wire harness in your kit. Start By placing the wire harness near the under hood fuse box. Run the Main transmission intercepting connector wire harness on the Banks Brake wire harness

down to the transmission following the factory transmission main connector harness from the transmission control module.

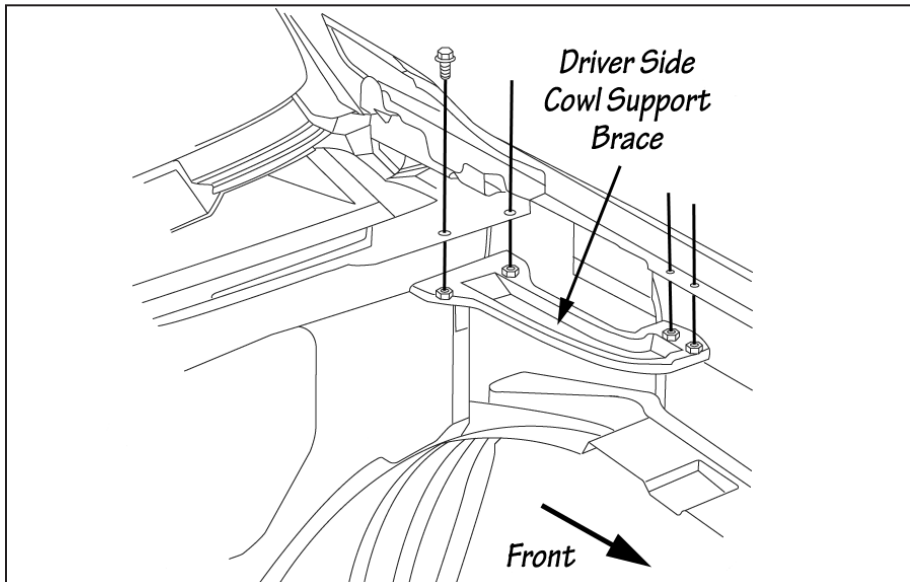
- 3.** On the right side of the transmission locate the transmission main connector. See **Figure 2**. Disconnect the connector by applying pressure on both sides and pull out.
- 4.** Insert the female connector on the Banks Brake wire harness into the transmission connector. Insert the factory main transmission connector to the male connector on the Banks Brake wire harness.

*NOTE: When installing the male connector to the transmission orient the arrow on the connector up.*

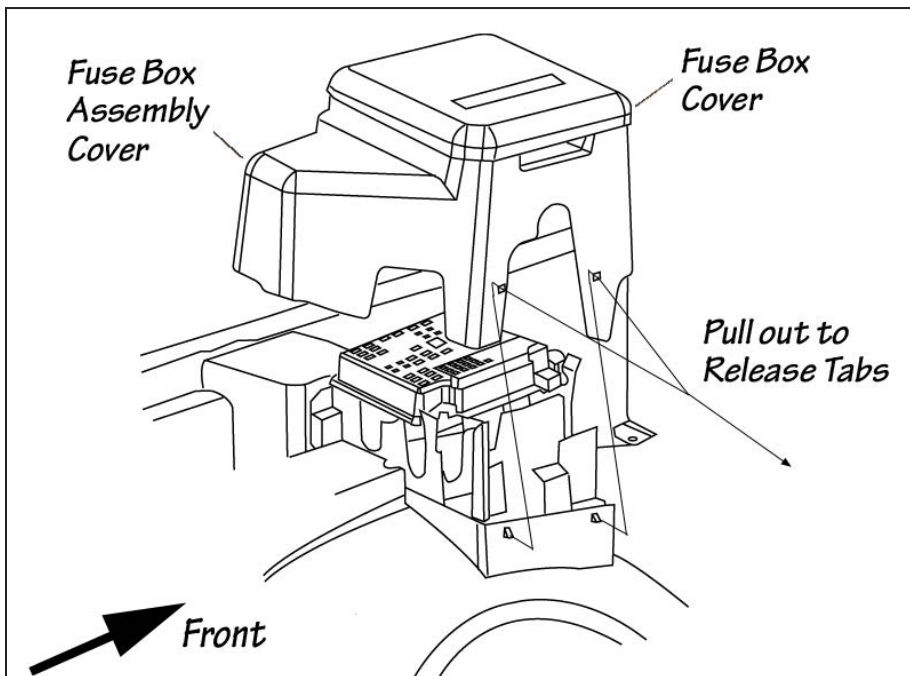




**Figure 3** Remove of Driver Side Cowl Support Brace



**Figure 4**



**Figure 5**



**5.** Secure the wire harness using some of the supplied cable ties along the factory wire harness up the left side of the engine to the Fuse box.

**6.** Remove the Driver side Cowl support Brace and retain hardware for reuse. See **Figure 3**.

**7.** Remove the fuse box cover to access the fuses on the electrical center and set aside.

**8.** Remove the fuse box assembly cover by expanding the fuse box out towards the engine side and lifting up, exposing the fuse electrical center. See **Figure 4**.

**9.** Push out on the tab closest to the fender and the two locking tabs on the side of the electrical center and lift up to gain access to the C100 Connector. Disconnect the C100 Connector. See **Figure 5**.

**10.** Install the ground ring terminal on the Banks Brake wire harness onto the bolt on the bottom of the electrical center closest to the fire wall. See **Figure 5**.

**11.** Insert the male C100 connector on the Banks Brake wire harness to the female C100 factory connector. Insert the female C100 connector on the Banks Brake wire harness to the male C100 factory connector.

**12.** Position the electrical center back in place until the tabs snap into place.

*NOTE: adjust the C100 connection under the electrical center to have sufficient room to lock the electrical center back in place. Run the wire harness out to the firewall side of the fuse brace. See **Figure 6**.*

**13.** Locate mini-fuse for the Body Control Module (TBC IGN1) and remove it. See **Figure 7**.

**Figure 6**



**14.** Install the mini-blade fuse tap onto the removed mini fuse as shown in **Figure 8**. Re-install the mini fuse with the attached blade tap into the fuse box.

*NOTE: install the fuse tap in the Body Control Module (TBC IGN1) spot closest to the firewall. This is the "hot" side of the circuit. See **Figure 7**.*

**15.** Locate the fuse connector wire on the Banks Brake wiring harness and connect it to the mini-blade fuse tap. Replace the fuse box assembly cover and make sure not to pinch the fuse connector wire.

**16.** Replace the fuse box cover.

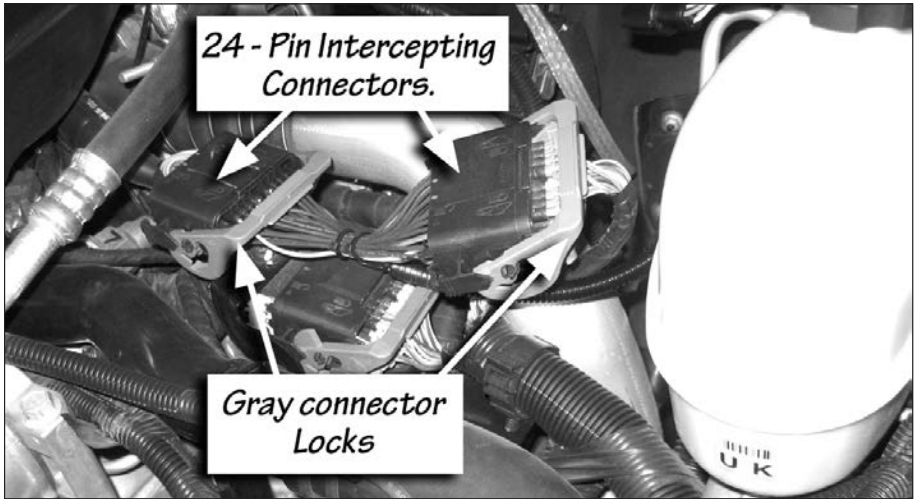
**17.** Locate the black wire harness locking connectors between the brake fluid reservoir and the air conditioning compressor. Lift the gray connector locks and disconnect the 24-pin connector pair. See **Figure 9**.

**18.** Insert the male 24 pin connector on the Banks Brake harness into the female 24-pin connector on the factory harness. Insert the female 24-pin connector on the Banks Brake harness onto the male 24-pin connector of the factory harness.

*NOTE: If vehicle is equipped with a Banks Tuner, disconnect the 24-pin connection between the factory 24-pin connectors and the Banks Tuner 24-pin connectors. It is not important if the intercepting connection is made before the Banks Tuner connection or after. This will not affect the performance of the Banks Tuner or Banks Brake. Insert the male 24 pin connector on the Banks Brake harness into the female 24-pin connector on the factory harness or Banks Tuner's harness. Insert the female 24-pin connector on the Banks Brake harness onto the male 24-pin connector of the factory harness or Banks Tuner's harness.*



**Figure 9**



If a Banks Diesel Tuner has been previously installed, skip step 20.

**19.** Locate the rubber grommet on the driver's side of the vehicle firewall. The grommet is about 3" in diameter. Make a 1" x 1" cross-shaped incision in the grommet. See **Figure 10**. Now from inside the cab locate the grommet on the firewall and make another 1" x 1" cross-shaped incision on the grommet.

**20.** Locate the In Cab Cable on Banks Brake wire harness and feed the single connector cable through the incision made in the firewall grommet and into the cab.

**21.** With the Banks Brake Module positioned on top of the fuse box, peel the protective backing from the hook and loop interlocking fasteners and attached to the Brake Module. Position the Brake module to the edge closest to the engine of the fuse cover then press the adhesive onto the outside of the fuse box cover. Apply light pressure to the Brake Module by hand for 60-seconds to create a strong bond

between the fuse box and hook & loop interlocking fasteners.

*NOTE: make sure the fuse box cover is clean and free of any oil residue and contaminates. Clean fuse box cover with a non-oil based solvent such as Acetone, Mineral Spirits, Denatured Alcohol or Lacquer Thinner. Read and follow the manufactures operation instruction for non-oil based solvent cleanser.*

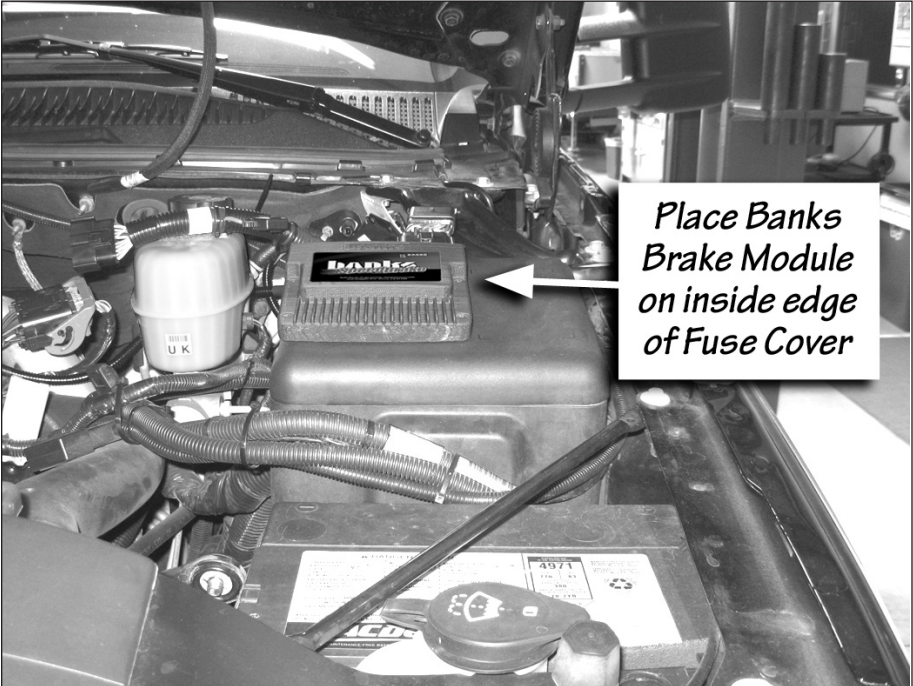
*If vehicle is equipped with a Banks Tuner, detach the Tuner from the top of the fuse box cover and reattach on the fuse box side or on top of the fuse box along with the Banks Brake. See **Figure 12 & 13**. If placing the Tuner on top of the fuse box along with the Brake module there may be some over hang from the tuner. Secure the tuner so that it stays in place. Use the supplied hook & loop interlocking fasteners to make the necessary adjustment to attach the Banks Brake to the top of the fuse box cover and Banks Tuner to the fuse box side or top.*



**Figure 10** Driver Side Firewall, Rubber Grommet

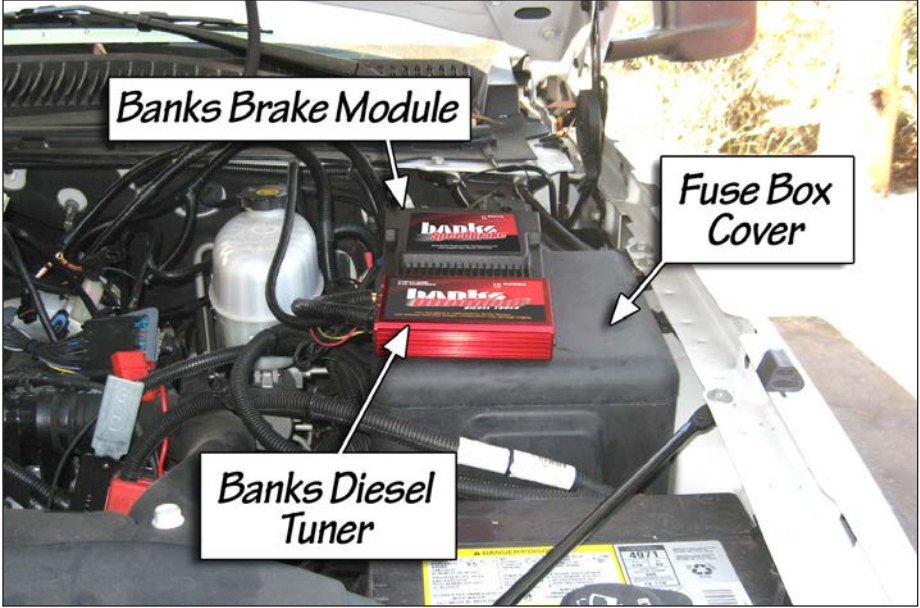


**Figure 11**

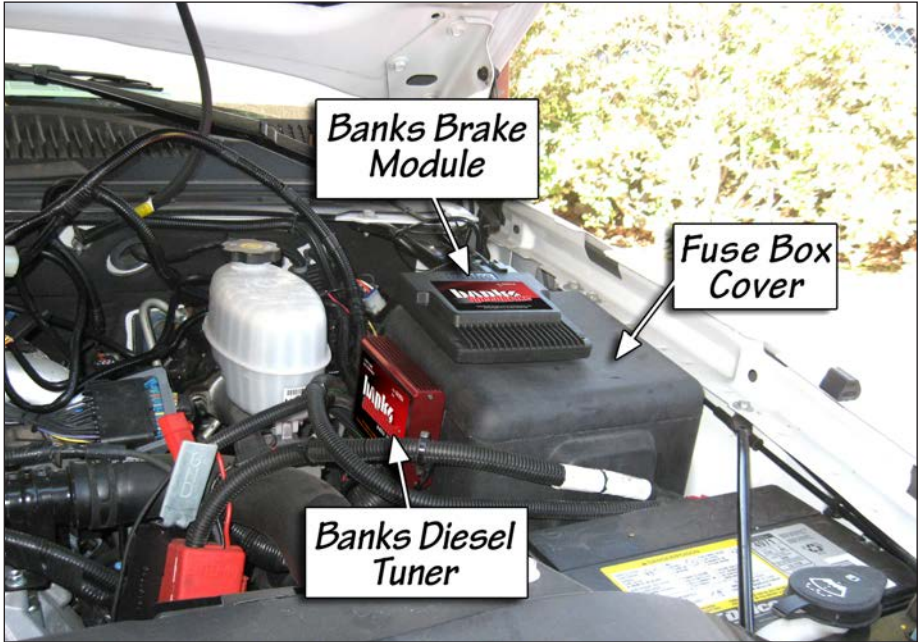


*Place Banks  
Brake Module  
on inside edge  
of Fuse Cover*

**Figure 12** Placement of Banks Tuner on top of the Fuse Box.



**Figure 13** Placement of Banks Tuner on side of the Fuse Box.



**WARNING: Make sure to place the Banks Brake Module as shown in Figure 11 to avoid a clearance issue when closing the hood. Mount the SpeedBrake Module as close to the inside edge of the fuse cover as possible.**

**22.** Insert the Banks Brake 20-pin female connector on the wire Harness to the Banks Brake Module. Using the supplied cable ties, secure the wire harness away from any heat sources (i.e. Driver side exhaust manifold) or moving components.

**23.** Reinstall the driver side cowl support brace. Tighten the factory hardware to 80 in-lbs.

**24.** Locate the Banks OBD II Interface Cable in your kit. This cable has three connection points. Connect the RED OBD II connector on the Banks interface cable to the vehicle OBD II connector. Use a cable tie as shown in **Figure 14** to secure the Banks

interface cable to the vehicle OBD II connector.

**25.** Next, connect the 6-pin connector on the Banks OBD II interface cable to the 6-pin connector on the Banks Brake wire harness routed through the firewall.

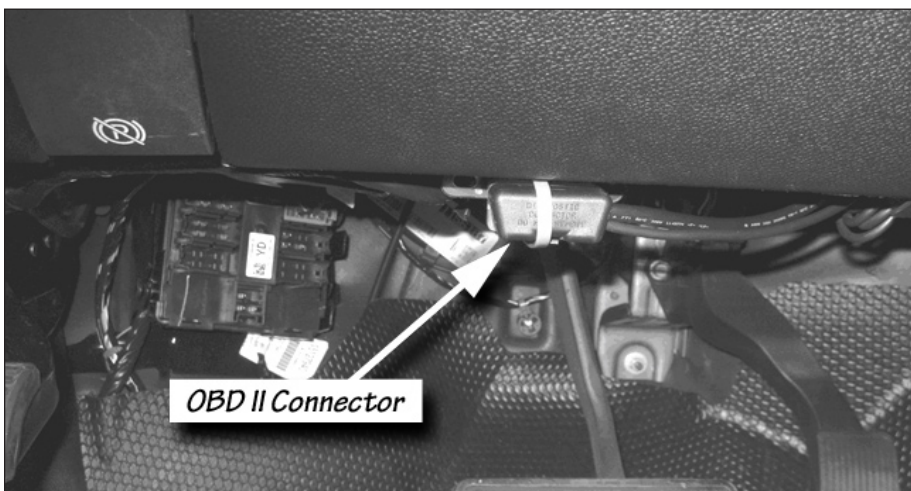
**26.** The RJ12 connector (phone like connector) on the Banks Brake Wire harness will be connected in the next section to the Brake level selector switch. Leave this wire loose for connecting to Brake level switch.

**27.** Go over all connection. Secure the wire harness with the supplied ties under the dash.

**WARNING: Take care to keep any cables away from the pedals or where they could become tangled.**

-END, SECTION 1-

**Figure 14**





# Section 2

## INSTALLATION OF BANKS BRAKE SWITCH

**CAUTION: Do not use force when working on plastic parts. Permanent damage to the part might result.**

**1.** The Banks Brake switch will be installed on the driver's side of the instrument panel (IP) next to the steering column (see **Figure 15**). If a Six-Gun Power Level Selector switch has been installed use the secondary drill location on supplied template and install the Banks Brake switch next to the Six-Gun switch. Carefully remove the IP from the dashboard by slowly pulling outwards from the dashboard around the edges of the IP, allowing the mounting pins to pull free from their dashboard sockets. Automatic transmission equipped vehicles will need to set the parking brake and move the shift lever down to the lowest gear to allow clearance for instrument panel removal.

**2.** Cut out the supplied template (see **Figure 20 on page 23**) and align

the template onto the rear of the IP, squarely seating it on the top of the IP mounting pin (see **Figure 16**).

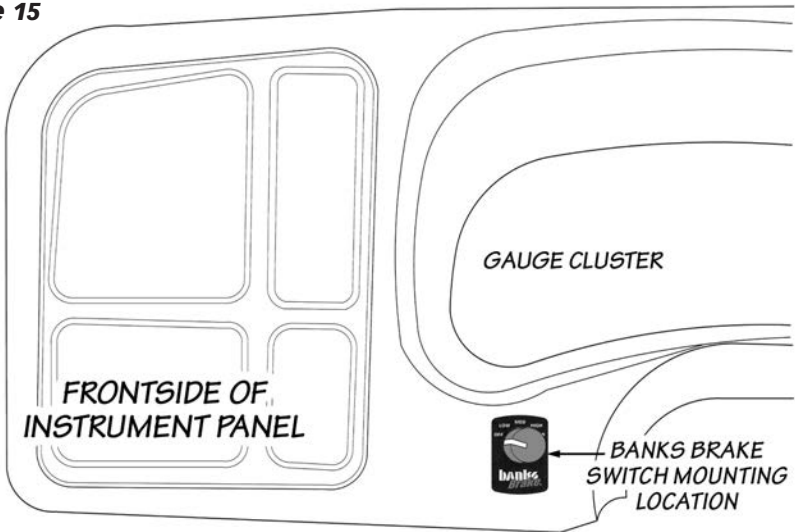
**3.** Using a  $\frac{3}{8}$ " Uni-drill bit, center the bit onto the  $\frac{3}{8}$ " drill location on the template and slowly drill through the IP. Using a  $\frac{1}{8}$ " drill bit, center and drill through the  $\frac{1}{8}$ " location on the template. Remove and discard the template and any plastic shavings.

**4.** On the front side of the IP, align the Banks Brake label onto the previously drilled hole (see **Figure 17**).

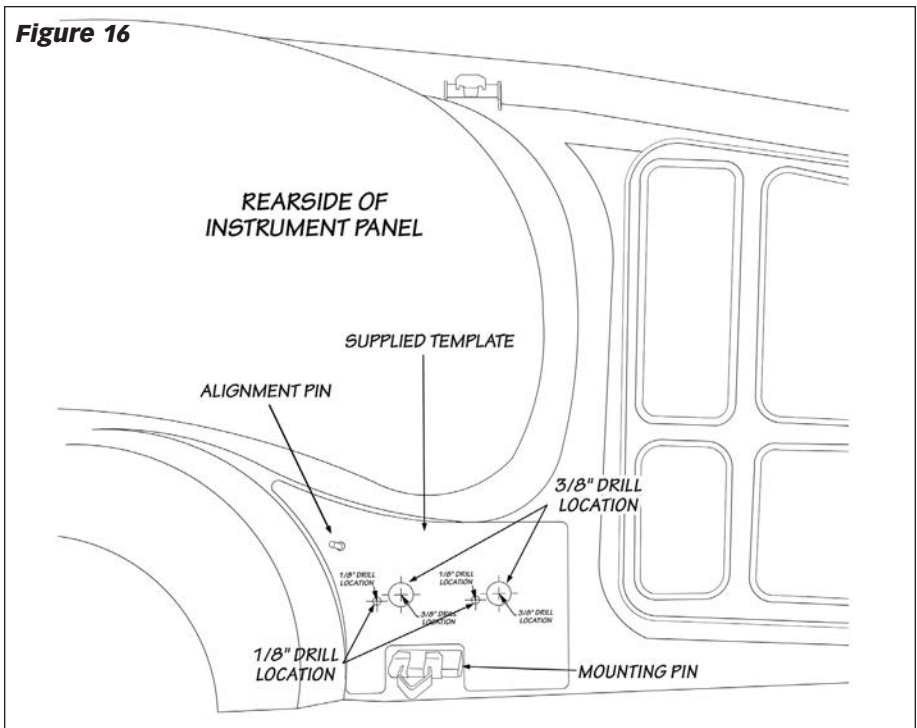
**5.** Remove the nut and internal tooth washer from the Banks Brake Switch. Rotate the shaft counter clockwise until the shaft stops. Verify the locating washer tab is inserted into the #5 position on the switch (see **Figure 18**).

*NOTE: If the washer is in any position other than the #5, your Speed Brake will not function properly.*

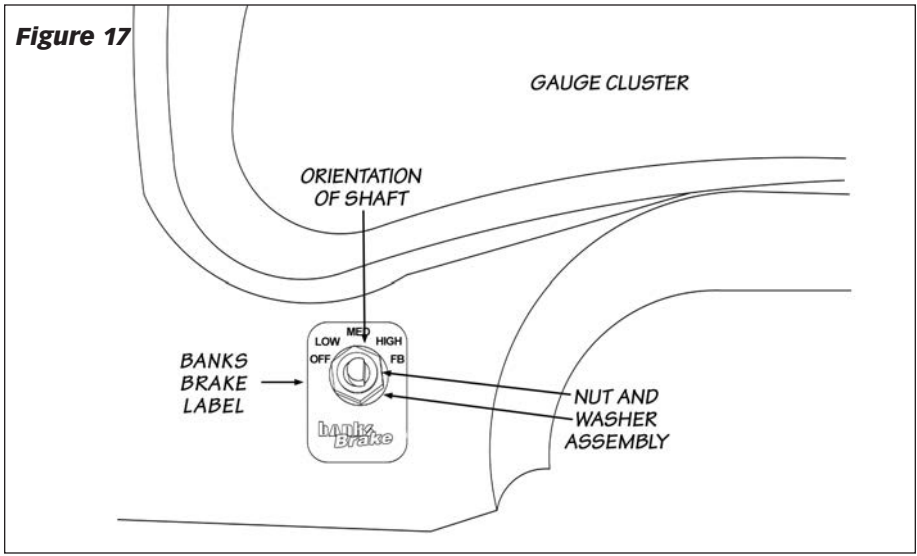
**Figure 15**



**Figure 16**



**Figure 17**



6. After confirming the locating washer is in the #5 location, install the switch through the  $\frac{3}{8}$ " hole on the backside of the instrument panel. The alignment pin should rest in the  $\frac{1}{8}$ " hole and with the switch fully rotated counter clockwise; the shaft's flat side should be facing the steering column. Secure switch with internal tooth washer and nut. Snug the washer; be careful not to over torque the nut and damage the plastic threads.

7. Install the knob onto the shaft facing the Off Level on the Banks Brake label. On the knob, snug the two (2) set screws with the supplied 0.050" hex key wrench.

8. Route the **RJ12 connector (phone like connector)** to the Banks Brake switch cable connector, and plug the connectors together.

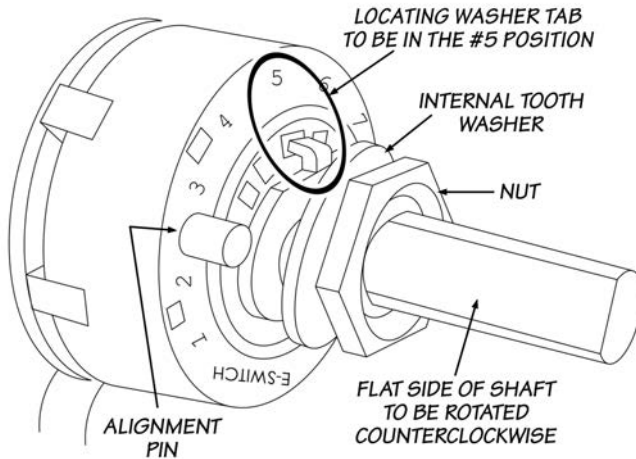
9. Reinstall the IP panel, make all electrical connections that were disconnected. Secure all loose wiring under the dash with supplied cable ties.

**WARNING: Take care to keep any cables away from the pedals or where they could become tangled.**

10. Reinstall the lower knee panel back in place with the factory hardware. Tuck any excess cable behind it for a clean appearance.

-END, SECTION 2-

**Figure 18**

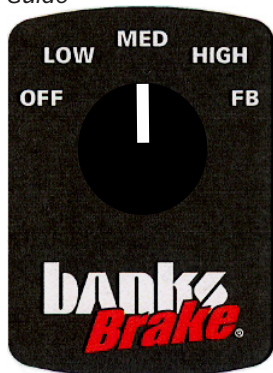


## Section 3

### BANKS BRAKE OPERATION

The Banks Brake has five (5) operating settings; HIGH, MED (medium), LOW, OFF and FB (Foot Brake Activation). See **Figure 19**.

**Figure 19:** Banks Brake Selector Switch Guide



OFF mode allows the vehicle to behave as if the Banks Brake is not present.

When the selector switch is turned to the LOW, MED, or HIGH settings, the Banks Brake will activate and will downshift the transmission and adjust the turbocharger vanes, resulting in a braking effect that slows your vehicle to 15 mph.

HIGH strength achieves the highest level of braking force by aggressively downshifting the transmission and closing the turbocharger vanes. This setting is recommended for heavily loaded vehicles or whenever aggressive braking is desired.

MED (medium) strength achieves a moderate level of braking force by slightly delaying transmission downshifts. This setting is recommended for moderately loaded vehicles.

LOW strength setting achieves a lower level of braking force and is recommended for lightly loaded or unloaded vehicles. The LOW setting may also be used for daily driving.

**CAUTION: Using the HIGH setting with a lightly loaded vehicle will result in VERY aggressive braking. Become familiar with the characteristics of the Strength Settings before encountering slippery road conditions, including rain, snow and icy.**

#### Foot Brake Activation

When Foot Brake Activation is selected the Banks Brake will only activate when the foot brake is applied. In this setting the Brake will apply the highest level of braking force to assist in slowing the vehicle.

To enable Foot Brake Activation, turn the Brake selector switch to the Foot Brake Activation (FB) level. To Disable, turn the switch to any other desired level.

**CAUTION: Your Banks Brake is NOT a substitute for the hydraulic brakes on your truck. The device will not correct or compensate for improperly maintained hydraulic brakes. Also, please be aware that your Banks Brake is not designed to be used as a parking brake or to bring your vehicle to a complete stop. Your Banks Brake is a supplementary braking system designed to help you slow down or to assist you in maintaining a more constant speed when descending a grade. Remember that Banks Brake is first and foremost a preemptive device and is most efficient when used to help prevent, rather than correct, a vehicle over speed situation.**

The use of a Banks Brake does not increase the load capacity of your vehicle. Gross combined Weight Rating specifications should always be adhered to. The Banks Brake will allow you to slow your vehicle more effectively within your vehicle's weight specifications.

## OPERATION/DRIVING

Now that you are familiar with the features that are available with Banks Brake, it is recommended that you experiment with the various settings prior to using the braking features in a towing or extreme driving situation. Under light load conditions on local streets, the MED (medium) setting is an appropriate starting point to provide a reasonable demonstration that the brake is functioning.

*NOTE: Whenever the brake is active and the footbrake is applied, the vehicle will not upshift until the throttle is pressed. This is also true even if cruise control is resumed.*

*For some model vehicles, whenever the brake is active the vehicles Tow-haul mode will activate. The tow-haul mode will deactivate when the Banks Brake is deactivated.*

## WHEEL SLIP DETECTION

The Banks Speedbrake continuously monitors wheel speeds to detect possible slippage caused by braking. If this occurs, the brake will shut off until traction is regained and then remain off for 30 seconds. This will be communicated as a fault via the Banks iQ Status Indicator.

-END, SECTION 3-

# Section 4

## BANKS BRAKE TROUBLESHOOTING

If you feel that your Banks Brake is not functioning properly, some diagnostics can be performed. Your Banks Brake module is equipped with diagnostic features that will detect and display certain errors.

Remove the Banks Brake Module from its mounting location while keeping all connectors plugged in, and position it in such a way that you can view the end of the Banks Brake housing that contains the LEDs from the driver's seat. Turn the vehicle key to the ON position. Observe the two LEDs mounted on the end of the Banks Brake Module:

- A steady GREEN LED will illuminate if all wire connections are correct, the engine is running, and the engine coolant temperature is within its normal operating range.
- The GREEN LED will flash if all wire connections are correct, the engine is running, but the engine coolant

temperature is not within its normal operating range. The GREEN LED will stop flashing once the engine coolant temperature is within its normal operating range (not to be confused with Speed-Loader flash on power-up).

- No LEDs will illuminate if the fuse on the Banks Brake wiring harness is blown or the wiring harness is not properly connected. If the fuse and all connections are okay, contact Banks Technical Service.
- The RED LED will flash in a certain sequence if a connection is incorrect or if there is a problem with the system – this sequence will identify one or more diagnostic codes. A Banks Brake diagnostic code is comprised of 2 digits. Each code is expressed in a sequence of 2 sets of the flashing red LED separated by a brief flashing of the green LED in between. Each set of a number of red LED flashes represents a digit. A longer flashing of the green

**Table 1 - (For 06-08 model years)**

<b>Flash Code</b>	<b>PDA Error Message</b>	<b>Corrective Action- LBZ/ LMM</b>
1.1	Code 11: VGT control input out of range	Turn ignition OFF and check the 24-Pin connector. Turn ignition back ON and re-check for presence of code.
1.2	Code 12: Vane Position Sensor input out of range.	Turn ignition OFF and check the 24-Pin connector. Turn ignition back ON and re-check for presence of code.
1.3	Code 13: Rear wheels slipping	None required. When traction is regained, error will clear after 30 seconds.
1.4	Code 14: Low power voltage detected.	Turn ignition OFF and check the Fuse Tap and the Ground O-ring. Turn ignition back ON and re-check for presence of code.
2.1	Code 21: VGT control output malfunction.	Turn ignition OFF and check the 24-Pin connector. Turn ignition back ON and re-check for presence of code.
2.2	Code 22: VGT control output overcurrent.	Turn ignition OFF and check the 24-Pin connector. Turn ignition back ON and re-check for presence of code.
2.3	Code 23: Low relay voltage detected.	Turn ignition OFF. Turn ignition back ON and re-check for presence of code.
2.4	Code 24: Vane Position Sensor voltage output malfunction.	Turn ignition OFF and check the 24-Pin connector. Turn ignition back ON and re-check for presence of code.
3.1	Code 31: OBD communication error.	Turn ignition off and check the OBD connector and cable. Turn ignition back ON and re-check for presence of code.
3.2	Code 32: Internal module malfunction or intermittent power.	Turn ignition OFF. Turn ignition back ON and re-check for presence of code.
3.3	Code 33: OBDII CAN communication output error.	Turn ignition OFF and check the 16-Pin C100 Intercepting connector. Turn ignition back ON and re-check for presence of code.
3.4	Code 34: OBDII CAN communication input error.	Turn ignition OFF and check the 16-Pin C100 Intercepting connector. Turn ignition back ON and re-check for presence of code.
4.2	Code 42: Torque Converter Clutch slippage detected.	Turn ignition OFF and check the 16-Pin C100 Intercepting connector. Turn ignition back ON and re-check for presence of code.
4.3	Code 43: Shift control malfunction.	Turn ignition OFF and check the 16-Pin C100 Intercepting and 20-Pin connectors. Turn ignition back ON and re-check for presence of code.
4.4	Code 44: Internal memory malfunction.	Turn ignition OFF. Turn ignition back ON and re-check for presence of code.

If problem persists, call Gale Banks Engineering Tech Support.

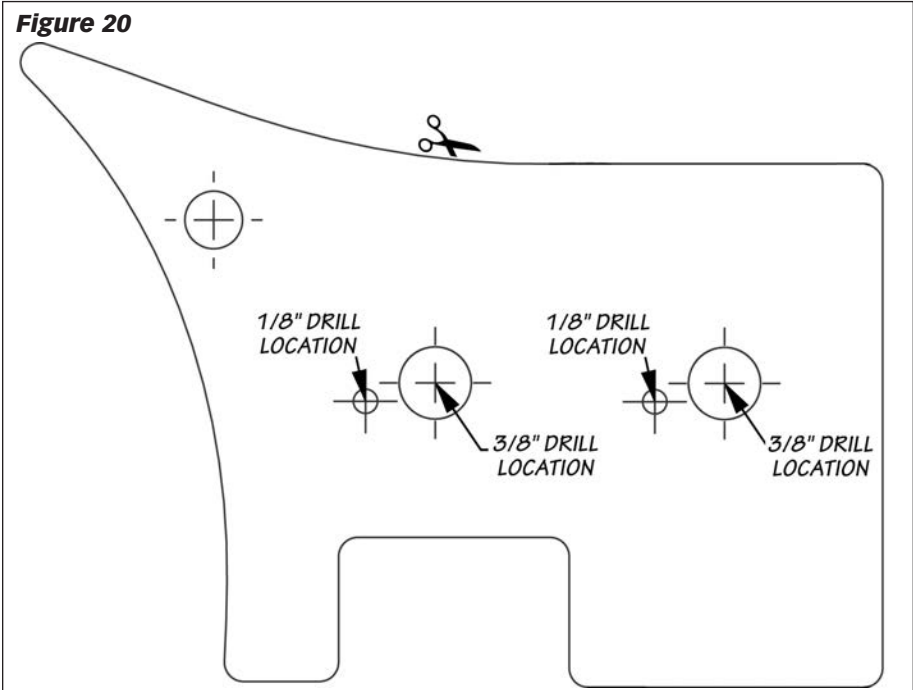
LED separates the sequences. The LEDs will continue to flash to display all the errors, and then repeat. **Table 1** lists the common diagnostic codes. For example, if a low relay voltage is detected (code "2,3") by the Banks Brake, the following red and green LED flashing sequence is observed when the key is on:

- (1) Two times flashing RED LED
- (2) One time quick flashing GREEN LED
- (3) Three times flashing RED LED
- (4) One time longer flashing GREEN LED

The above flashing sequence will repeat continuously. When the problem is corrected, the diagnostic code will be eliminated and replaced by a steady green light. If problem persists, contact Banks Technical Service.

*NOTE: If multiple codes are set, they will be displayed in a series separated by the longer flashing green LED. When reading codes, make sure to watch the entire series until you see the first code repeat.*

-END, SECTION 4-



# Section 5

## PLACEMENT OF THE BANKS POWER DECALS

