

Owner's Manual with Installation Instructions

Banks Six-Gun[®] /EconoMind[®] Diesel Tuner

Compatible with Optional Banks iDash[®]

**2003-2007 (235, 250, 305 and 325 HP) Dodge
5.9L Cummins (24-valve) ISB Pickup Trucks**

THIS MANUAL IS FOR USE WITH SYSTEM 63808, 61022, 63723, 63725, 63793,
63795, 63797, 63807, 63809, 63817, 63818 & 63819

For iDash 1.8 instructions, see iDash 1.8 manual 97654 & 97674

Product available from Banks Power for the '03-07 Dodge 5.9L

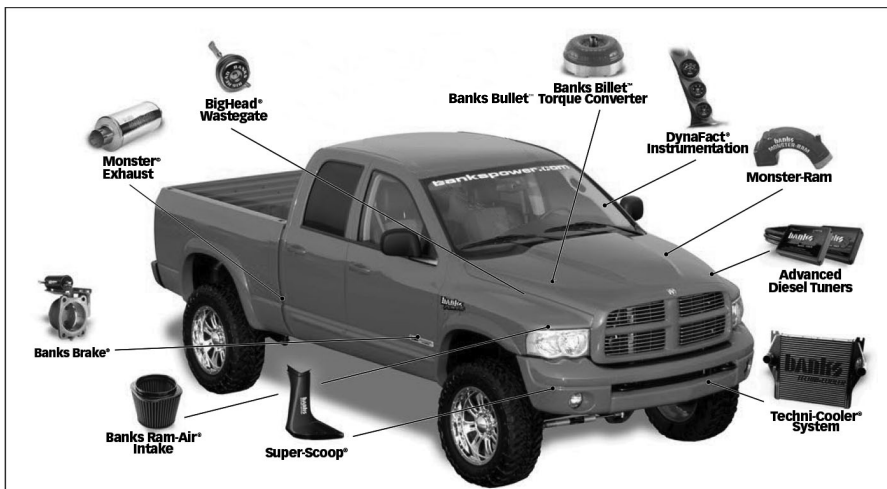

Banks Monster® Exhaust System

Single (P/N 48640-48643, 48700, 48701, 48708)

Duals (P/N 48702-48707, 48709)

Sport (P/N 48777-48780)

- Increases exhaust flow, cuts backpressure, lowers exhaust gas temperatures (EGTs) and increases power.

Banks Ram-Air Intake System (P/N 42145)

- Increases your airflow over stock.
- Adds power, improves fuel economy, lowers EGTs and reduces smoke.

Banks Ram-Air Intake Super-Scoop (P/N 42190-42191)

- Adds cooler denser air to the Ram-Air Intake housing, further increasing fuel economy, reducing smoke and lowers EGTs.

Banks Monster-Ram (P/N 42765-42766)

- Increased flow from intercooler
- Raises boost without increasing backpressure at the turbine

Big Hoss Intake Manifold System (P/N 42747)

- Increases flow and provides more uniform air distribution to the engine for more available power at a given boost level.

Banks Exhaust Brake (P/N 55222-55229)

- Increases the stopping power of your truck and extends the service life of your brakes.

Banks Techni-Cooler® System (P/N 25980-25981)

- Provides increased air flow to the engine by increasing air density for more increased power, lower EGTs and improved fuel economy.

Banks SmartLock (P/N 55270)

- Reduces wear on transmission
- Locks Torque Converter and raises trans-line pressure
- Works with Banks Exhaust Brake

Boost and Pyro Gauges (P/N 64507)

- Keep your engine safe by monitoring vital engine parameters.

Banks Billet Torque Converter (P/N 72515)

- Higher torque capacity over stock
- Lockup clutch is slip-resistant so transmission fluids stay cooler and transmission life is prolonged.

Banks Diesel Tuner

EconoMind w/switch (P/N 63725, 63793, 63795)

EconoMind w/iQ (P/N 63807, 63808, 63817, 63818)

Six-Gun w/switch (P/N 61022, 63797)

- Adds power safely to your vehicle
- Engine and transmission safeguards
- Change power levels on-the-fly

Thermocouple/EGT Temperature Limit Kit

- Add a temperature limiting function to your Diesel Tuner. **(P/N 63077)**

Banks BigHead® Actuator (P/N 24331) ('03, early '04 Only)

- Achieves a higher peak boost over stock and gives you precise boost control that gives you crisp acceleration and more mid-range pulling power.

THIS IS A HIGH PERFORMANCE PRODUCT. USE AT YOUR OWN RISK.

Do not use this product until you have carefully read the following agreement.

This sets forth the terms and conditions for the use of this product. The installation of this product indicates that the BUYER has read and understands this agreement and accepts its terms and conditions.

Disclaimer of Liability

Gale Banks Engineering Inc., and its distributors, employees, and dealers (hereafter "**SELLER**") shall in no way be responsible for the product's proper use and service. The **BUYER** hereby waives all liability claims.

The **BUYER** acknowledges that he/she is not relying on the **SELLER'S** skill or judgment to select or furnish goods suitable for any particular purpose and that there are no liabilities which extended beyond the description on the face hereof and the **BUYER** hereby waives all remedies or liabilities, expressed or implied, arising by law or otherwise, (including without any obligations of the **SELLER** with respect to fitness, merchantability, and consequential damages) whether or not occasioned by the **SELLER'S** negligence.

The **BUYER** is responsible to fully understand the capability and limitations of his/her vehicle according to manufacturer specifications and agrees to hold the **SELLER** harmless from any damage resulting from the failure to adhere to such specifications. The **SELLER** disclaims any warranty and expressly disclaims any liability for personal injury or damages. The **BUYER** acknowledges and agrees that the disclaimer of any liability for personal injury is a material term for this agreement and the **BUYER** agrees to indemnify the **SELLER** and to hold the **SELLER** harmless from any claim related to the item of the equipment purchased. Under no circumstances will the **SELLER** be liable for any damages or expenses by reason of the use or sale of any such equipment. The **BUYER** is responsible to obey all applicable federal, state, and local laws, statutes, and ordinances when operating his/her vehicle, and the **BUYER** agrees to hold **SELLER** harmless from any violation thereof. The **SELLER** assumes no liability regarding the improper installation or misapplication of its products. It is the installer's responsibility to check for proper installation and if in doubt, contact the manufacturer. The **BUYER** is solely responsible for all warranty issues from the automotive manufacturer.

Limitation of Warranty

Gale Banks Engineering Inc., (hereafter "**SELLER**") gives Limited Warranty as to description, quality, merchantability, fitness for any particular purpose, productiveness, or any other matter of **SELLER's** product sold herewith. The **SELLER** shall be in no way responsible for the product's open use and service and the **BUYER** hereby waives all rights except those expressly written herein. This Warranty shall not be extended or varied except by written instrument

Under no circumstance shall the **SELLER** be liable for any labor charged or travel time incurred in diagnosis for defects, removal, or reinstallation of this product, or any other contingent expense.

Under no circumstances will the **SELLER** be liable for any damage or expenses incurred by reason of the use or sale of any such equipment.

In the event that the buyer does not agree with this agreement:

The buyer may promptly return this product, in a new and unused condition, with a dated proof-of-purchase, to the place-of-purchase within thirty (30) days from date-of-purchase for a full refund, less shipping and/or restocking fee.

The installation of this product indicates that the buyer has read and understands this agreement and accepts its terms and conditions.

The Six-Gun/EconoMind Diesel Tuner has six selectable power levels which can be changed on the fly. Depending on which system you have you will adjust your power levels with a rotary switch or with the Banks iDash. Level 1 is stock. Each additional level will add approximately 20% of the available power increase, with level 6 providing maximum power gain.

To prevent damage to the factory transmission, Banks recommends that both automatic and manual transmission vehicles do not exceed Level 4 while the vehicle is experiencing load (towing, climbing a steep grade, carrying a load, etc.).

To use the higher levels of the Six-Gun/EconoMind Diesel Tuner while towing or climbing, airflow improvements must be made to lower the exhaust gas temperature (EGT) entering the turbo. The EGT should not exceed 1400° F for more than a few seconds. Elevated EGT can damage the turbocharger and the engine.

ATTENTION! Before proceeding with these instructions, please carefully read the DISCLAIMER OF LIABILITY and LIMITATION OF WARRANTY statement located on page 4 of this manual.

TOOLS REQUIRED:

- Standard and metric deep sockets
- Standard and metric combination and open-end wrenches
- Standard and Philips head screwdrivers
- Pocket or X-Acto knife
- Pliers
- Shop towels
- Multimeter or 12-volt tester
- Wire cutters
- Scissors
- Drill motor
- 1/8", 13/32" and 7/16" drill bits
- Tap handle
- 1/4" NPT tap
- Foot-pound torque wrenches
- Penetrating oil or light lubricant spray
- Anti-seize compound
- Heat gun

Table of Contents

General Installation Practices	8
Section 1	9
Installation of Wiring Harness, Connections and Six-Gun/EconoMind Diesel Tuner	
Section 2	18
Mounting and Connecting the Banks iDash	
Section 3	21
Installation of the Six-Gun/EconoMind Selector switch	
Section 4	24
Optional Thermocouple Installation	
Section 5	25
Automatic Transmission Learning	
Section 6	27
Checking Engine Performance	
Section 7	28
Troubleshooting	
Section 8	32
Clearing Learned Information	
Section 9	33
Placement of the Banks Power Decals	
Section 10	34
Removal of the Six-Gun/EconoMind Diesel Tuner	

General Installation Practices

NOTICE: A Pyrometer (EGT) probe must be installed in conjunction with the Six-Gun/EconoMind Diesel Tuner in order to enable the Six-Gun/EconoMind's EGT limiting function. Using the Six-Gun/EconoMind Tuner without a Pyrometer probe can lead to detrimental damage to the engine due to excessive EGT temperatures. EGT Temperature Limit Kit sold separately (P/N 63077). EGT probe is included with the EconoMind.

- 1.** Before starting work, familiarize yourself with the installation procedure by reading all of the instructions.
- 2.** The exploded views provide only general guidance. Refer to each step and section diagram in this manual for proper instruction.
- 3.** Throughout this manual, the left side of the vehicle refers to the driver side, and the right side to the passenger side.
- 4.** Disconnect the negative (ground) cable from the battery (or batteries, if there are two) before beginning work.
- 5.** Route and tie wires and hoses a minimum of 6" away from exhaust heat, moving parts and sharp edges. Clearance of 8" or more is recommended where possible.
- 6.** When raising the vehicle, support it on properly weight-rated safety stands, ramps or a commercial hoist. Follow the manufacturer's safety precautions. Take care to balance the vehicle to prevent it from slipping or falling. When using ramps, be sure the front wheels are centered squarely on the topsides. When raising the front of the vehicle, put the transmission in park (automatic) or reverse (manual), set the parking brake, and block the rear wheels. When raising the back of the vehicle, be sure the vehicle is on level ground and the front wheels are blocked securely.

CAUTION: Do not use floor jacks to support the vehicle while working under it. Do not raise the vehicle onto concrete blocks, masonry or any other item not intended specifically for this use.

- 7.** During installation, keep the work area clean. Do not allow anything to be dropped into intake, exhaust, or lubrication system components while performing the installation, as foreign objects will cause immediate engine damage upon start-up.
- 8.** Save this Owner's Manual as a reference for system maintenance and service.
- 9.** Banks recommends either a Banks iDash or a Pyrometer (EGT) gauge and Boost gauge be installed with the Six-Gun Diesel/EconoMind Tuner to help monitor performance and exhaust gas temperature of the vehicle (see part numbers on page 2-3). To further increase engine life by lower EGT's, Banks also recommends installing a Monster Exhaust system (see page 2-3).

Section 1

INSTALLATION OF WIRING HARNESS, CONNECTIONS AND SIX-GUN/ECONOMIND DIESEL TUNER

1. Disconnect the battery ground cables from each of the batteries. Secure the cables so that they do not come in contact with the battery posts during the installation.
2. Place the Six-Gun Diesel/EconoMind Tuner box on top of the fuse box located in the left front side in the engine compartment. See **Figure 2**. The in-cab cable with the three small connectors will be routed into the cabin via the grommet on the firewall. The other two harnesses will be routed under the intake to their prospective locations listed in the following steps.
3. Locate the rubber grommet on the drivers side firewall. Using a utility knife, make a 1.5-inch-long slit in the grommet next to the wire harness.

Be careful not to cut or damage the harness. See **Figure 3** for the proper location of the required cut. Insert a screwdriver from the engine compartment into the cut hole and gently thrust it through the grommet.

4. Inside the vehicle, remove the lower dash panel beneath the steering column by removing the two (2) screws at the bottom of the panel. Retain the screws for re-installation.

NOTE: There are also two (2) clips located at the top corners of the panel, which hold the panel in place. These clips can be released by gently pulling on the corners of the panel. Use caution to avoid damaging the panel during removal.

Figure 1 Six-Gun/EconoMind and supplied wiring harnesses

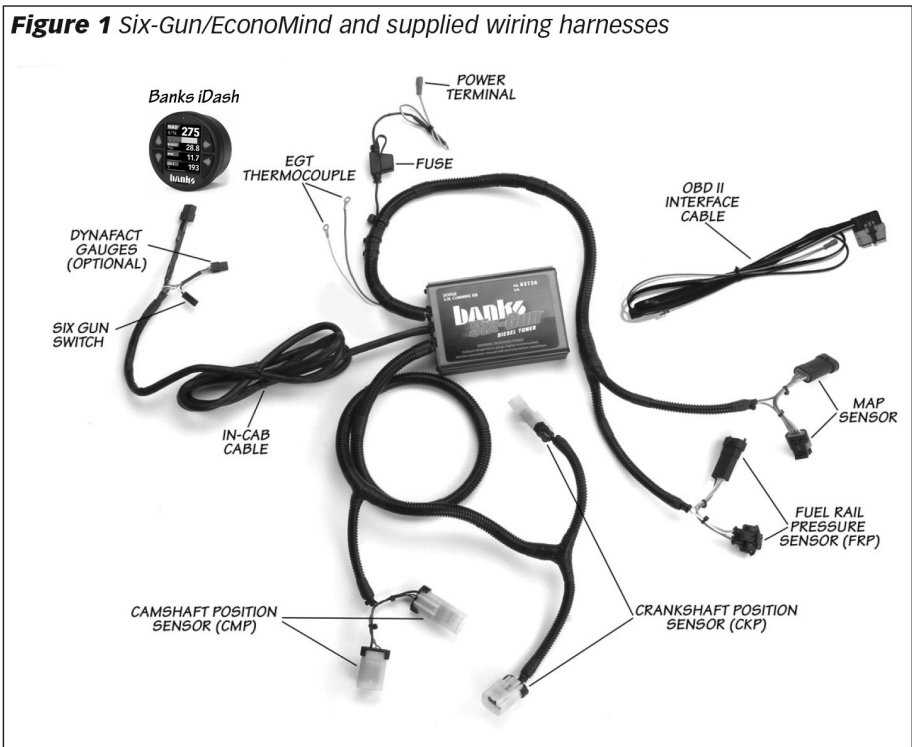

Figure 2

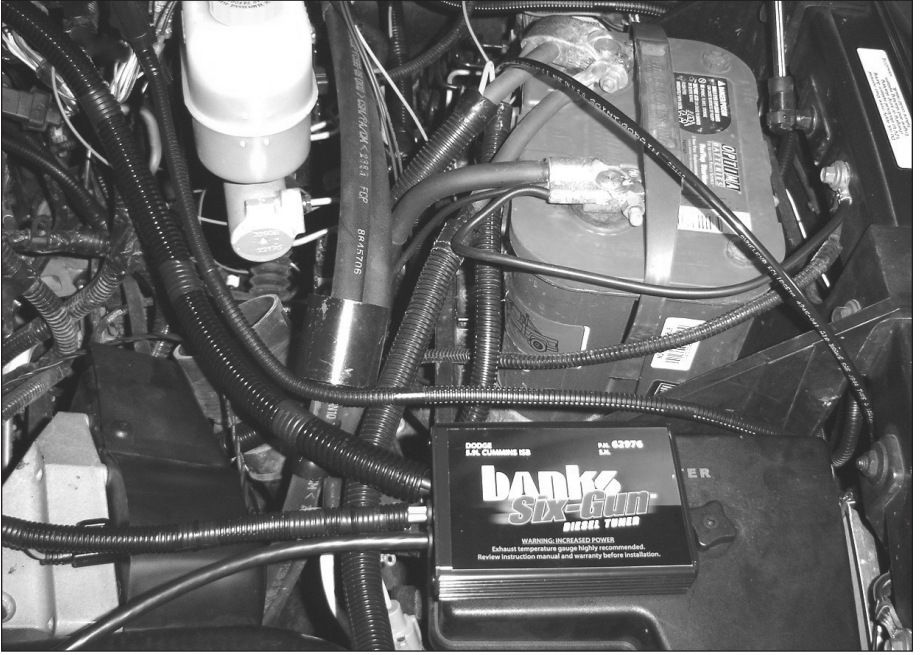
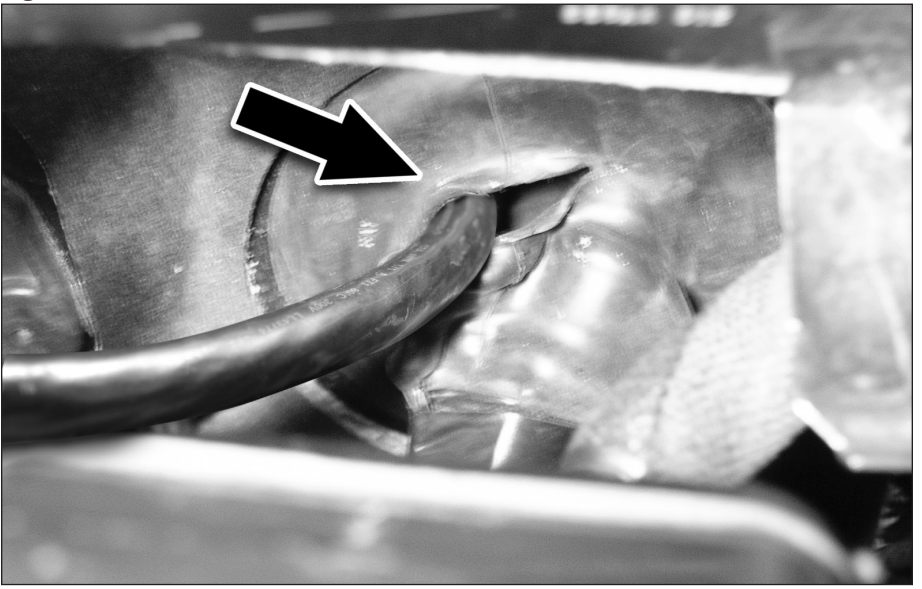

Figure 3



5. Remove the electrical connector bracket on the left hand side of the support below the steering column in front of the firewall by removing the two (2) bolts. This will allow access to the inner grommet. See **Figure 4**.

6. Cut the grommet on the firewall inside the vehicle along the hole created by the screwdriver in **Step 3**.

7. Locate the in-cab cable with the three connectors. From the engine compartment, push the in-cab cable through the hole cut in the firewall grommet.

NOTE: Taping the end of the cable to a piece of stiff wire (i.e. coat hanger) may make routing the cable through the firewall a simpler task. The stiff wire should be pushed through the slit in the grommet and then the wires can be attached to the stiff wire and pulled through the hole in the grommet.

CAUTION: Pull gently to avoid damage to the cable connectors. Always pull on the cable sheath rather than the wires themselves.

8. From inside the vehicle, continue to pull the in-cab cable through the firewall until it is approximately 22" inside the cab. Secure the cable to the lower access panel area. Take precaution to leave the three connectors accessible for usage further in the installation process.

9. Locate the Banks OBDII Interface Cable and 11" cable tie in your kit. Connect the OBDII Interface Cable to the vehicle OBDII connector. Use the 11" cable tie as shown in **Figure 5** to secure the Banks interface cable to the vehicle OBDII connector. Now, connect the 8-pin connector from the Banks OBDII Interface Cable to the 8-pin connector on the Six-Gun/EconoMind Tuner in-cab cable. *NOTE: If you are not installing the optional Banks IQ then coil up and secure the cable with the RJ12 (telephone style) connector end.*

Figure 4

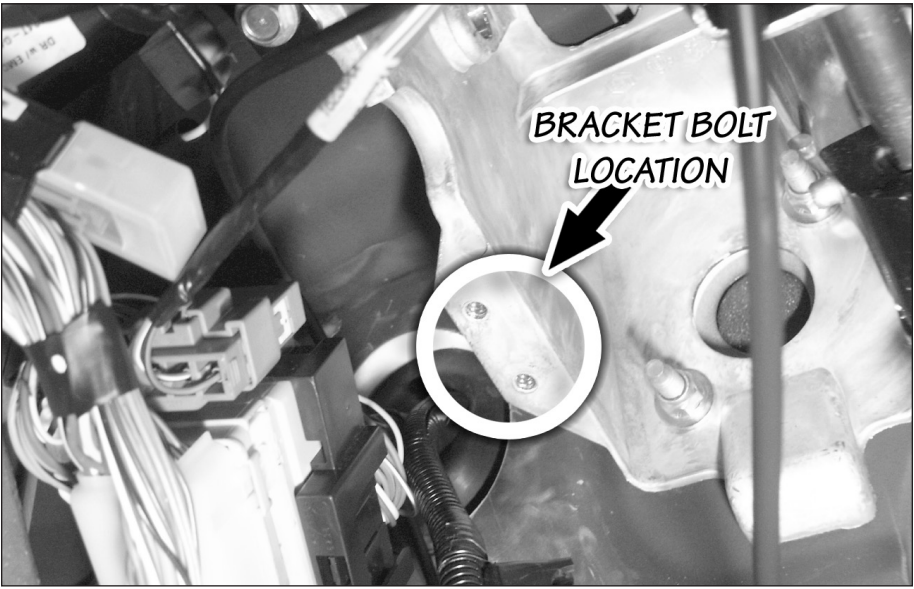

10. In the engine compartment find the Fuel Rail Pressure (FRP) sensor on the fuel rail. It is located on the drivers side of the engine. Unplug the factory connector and plug it into the corresponding male FRP sensor connector on the Six-Gun/EconoMind harness. Plug the Six-Gun/EconoMind's female FRP sensor connector into the sensor. See **Figure 6**.

11. Locate the Manifold Pressure (MAP) sensor on top of the intake manifold. Unplug the factory connector and plug it into the corresponding male MAP sensor connector on the Six-Gun/EconoMind harness. Plug the Six-Gun/EconoMind's female MAP sensor connector into the sensor. See **Figure 6**.

CAUTION: The Camshaft Position (CMP) sensor and the Crankshaft Position (CKP) sensor have the same type of connectors and they are in close proximity to one another.

Make sure the right connectors are used when installing these connections. Refer to Figure 7. for their locations on the Six-Gun/EconoMind Diesel Tuner wire harness.

12. Locate the Crankshaft Position (CKP) sensor on the lower front left side of the engine. It is behind the engine crankshaft pulley (engine harmonic balancer). Unplug the factory connector and plug it into the corresponding male CKP sensor connector on the Six-Gun/EconoMind harness. Plug the Six-Gun/EconoMind's female CKP sensor connector into the sensor.

Take care to route the wire harness away from the power steering pump pulley and secure it with the supplied cable ties. See Figure 8.

Figure 5

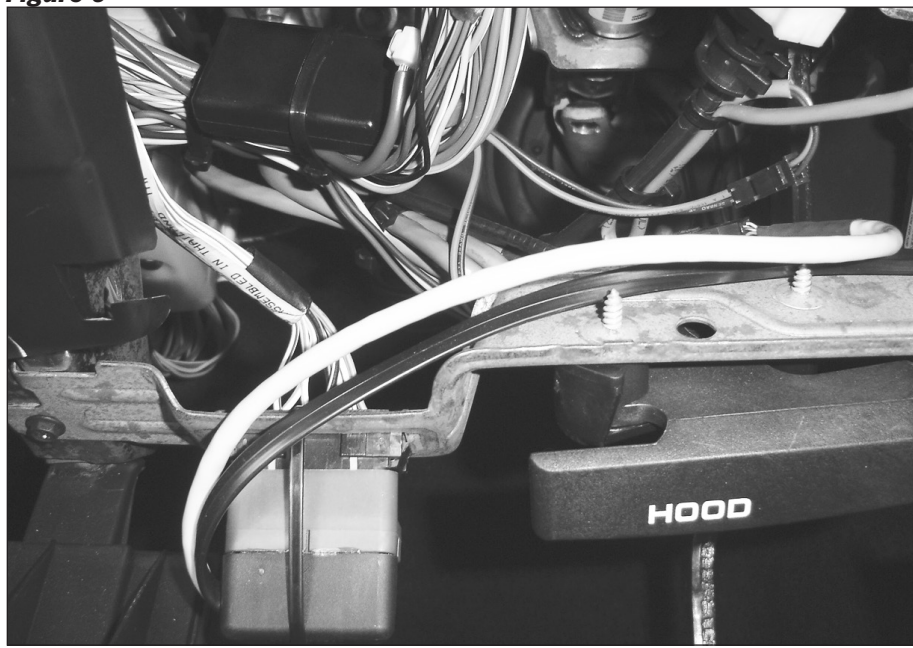

Figure 6

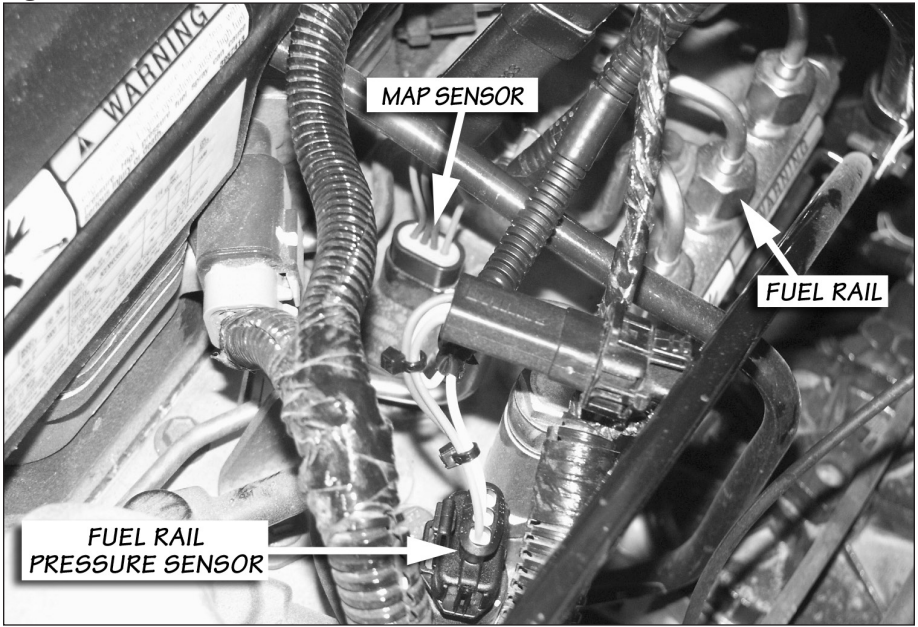
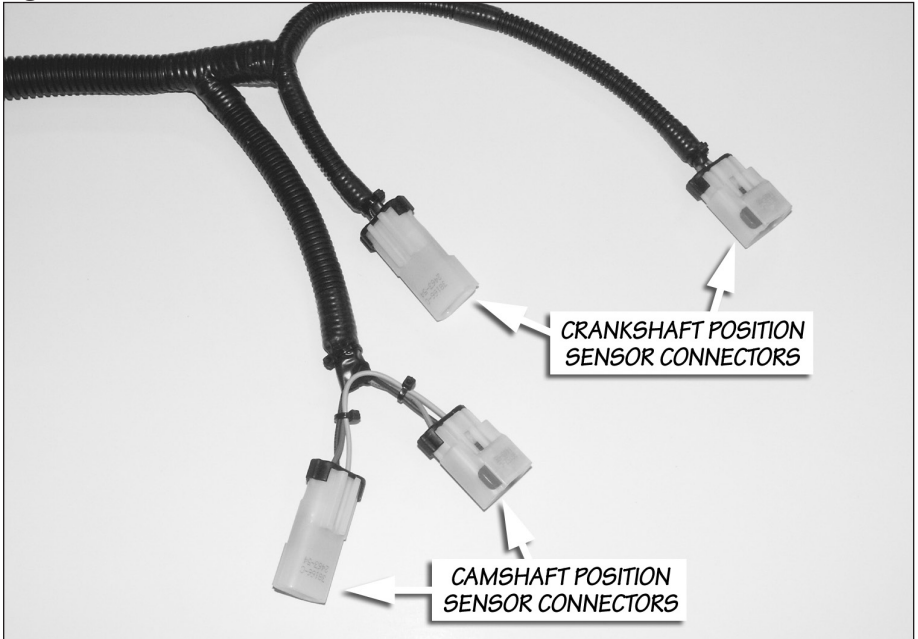

Figure 7



13. Locate the Camshaft Position (CMP) sensor below the fuel injection pump between the timing gear cover and the ECM. Unplug the factory connector and plug it into the corresponding male CMP sensor connector on the Six-Gun/EconoMind harness. Plug the Six-Gun/EconoMind's female CMP sensor connector into the sensor. See **Figure 9**.

14. NOTE: Very important to select proper fuse:

2003-2005 Fuse #50
2006-2007 Fuse #28

Remove the fuse box cover, located in left front side of the engine compartment.

2003-2005 Model Year Only

Locate the mini-fuse #50 and remove it. Install the mini-auto blade tap onto the removed mini fuse as shown in **Figure 10**. Re-install the mini fuse with the attached blade tap into location

#50 as shown in **Figure 11**. Plug in the terminal to the mini-auto blade.

2006-2007 Model Year Only

Locate the mini-fuse #28 and remove it. Install the mini-auto blade tap onto the removed mini fuse as shown in **Figure 10**. Re-install the mini fuse with the attached blade tap into location #28 as shown in **Figure 12**. Plug in the terminal to the mini-auto blade.

NOTE: Install the mini-auto blade tap on the terminal leg closest to the firewall. This is the "hot" side of the circuit.

CAUTION: It is very important that you select the proper fuse. The Banks Six-Gun Diesel/EconoMind Tuner will not function properly if installed incorrectly.

15. It is recommended to cut a small notch in the fuse box cover as shown in **Figure 13**, to avoid a crimped or

Figure 8

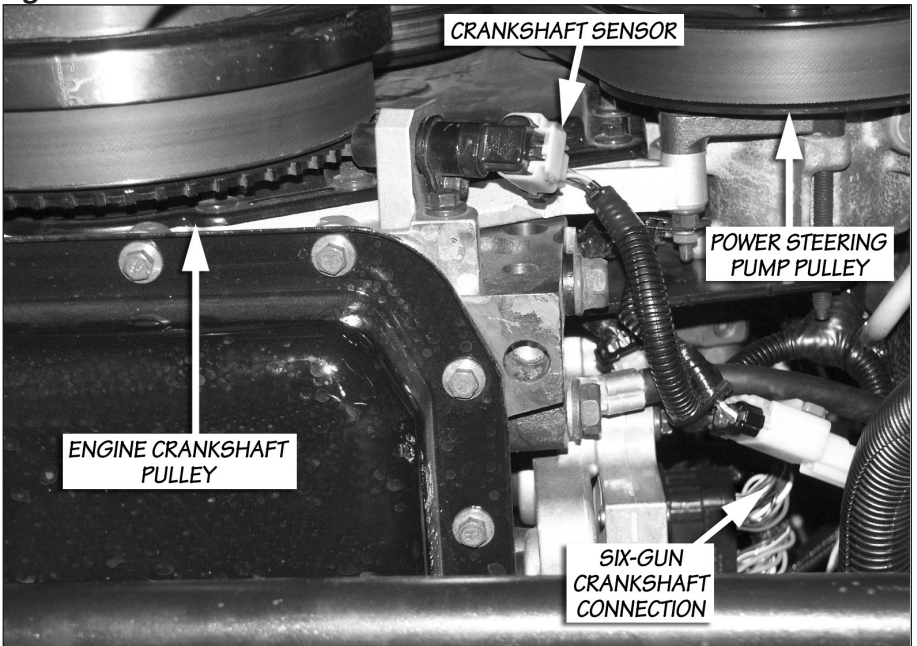

Figure 9

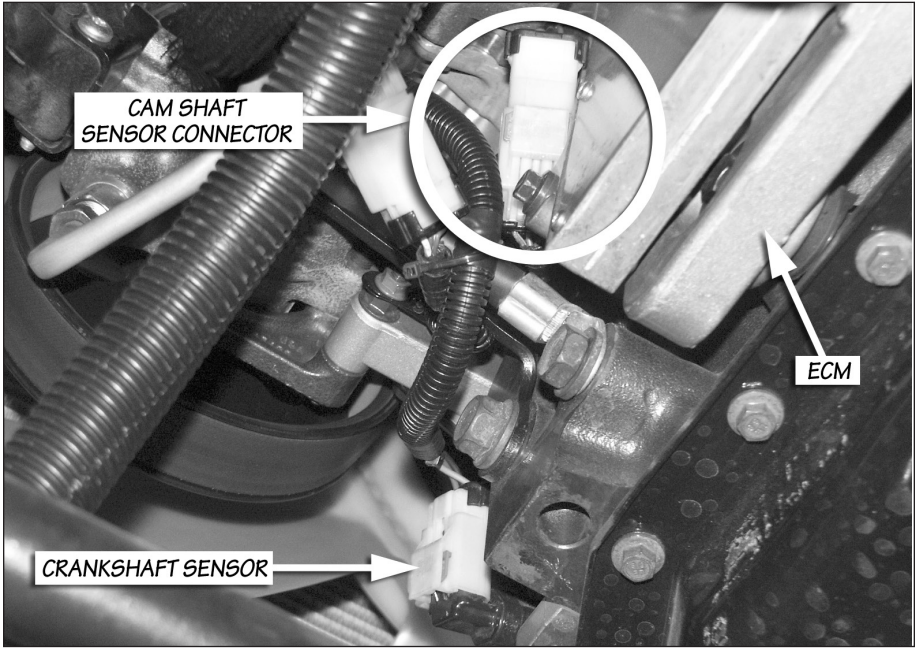

Figure 10

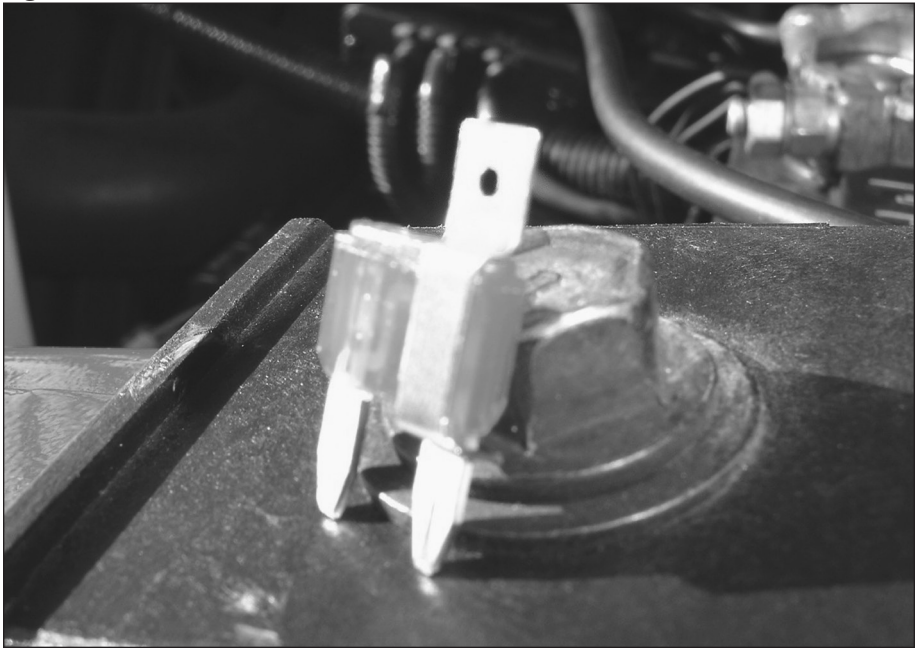

Figure 11

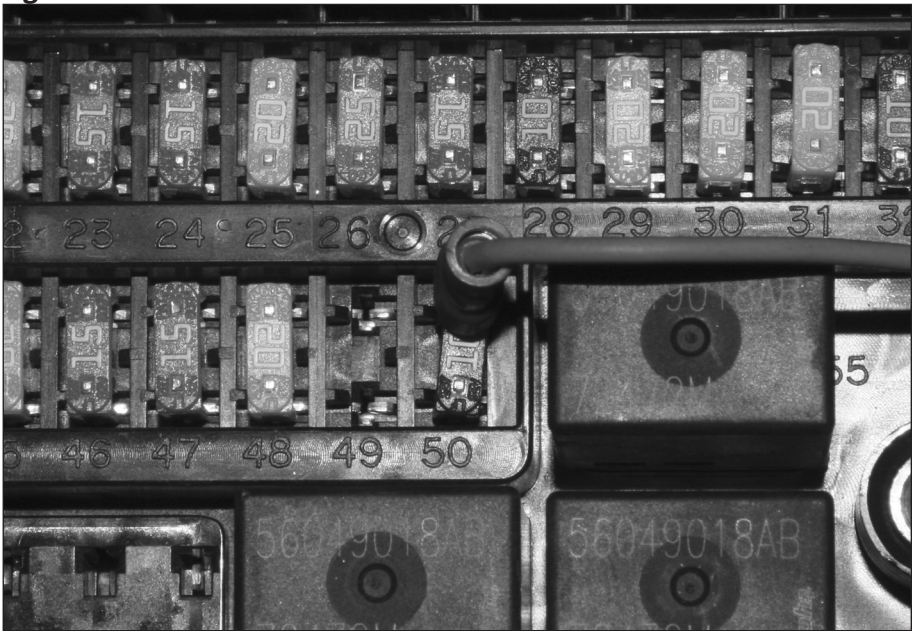

Figure 12



stressed wire. Locate the RED/WHT wire with the Power Terminal on the Six-Gun/EconoMind tuner wire harness and connect it to the mini-fuse blade tap. Replace the fuse cover and make sure not to pinch the RED/WHT power wire.

NOTE: Go over the entire installation as a precautionary check to ensure that all clamps are tight, wiring and hoses are properly routed, and connections are correct and tight. Make sure that the Six-Gun/EconoMind wire harness is not lying in the way of the brake and gas pedals, or any moving parts.

16. (Engine Compartment) After confirming all of the system connections are correct, make sure the entire mounting surface is clean and free of dirt and oil before mounting the Six-Gun/EconoMind Diesel Tuner. Clean and dry as required using a cloth

dampened with rubbing alcohol or a similar cleaning solution.

17. Hold the Six-Gun/EconoMind Tuner against the fuse box cover for approximately 1 minute while applying pressure to allow the adhesive to properly adhere to the surface.

-END, SECTION 1-

CAUTION: Do not spray fluid directly onto any electrical equipment, or equipment damage may result. Mount the Six-Gun/EconoMind Diesel Tuner on the top of the fuse box cover as shown in Figure 2, by peeling the protective backing off the adhesive tape on the back of the Six-Gun/EconoMind Diesel Tuner.

Figure 13

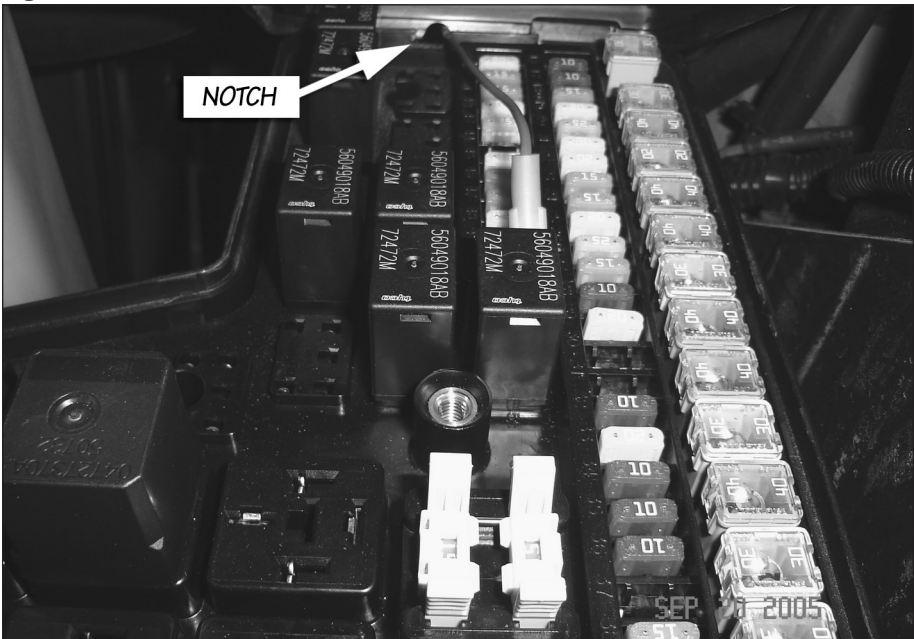

Section 2

MOUNTING AND CONNECTING THE BANKS iDash



FOR IDASH 1.8 INSTRUCTIONS, SEE IDASH MANUAL 97654 & 97674

If not installing the optional
Banks iDash, skip to Section 3.

Section 3

INSTALLATION OF THE SIX-GUN/ECONOMIND SELECTOR SWITCH

Not needed if optional Banks iDash is installed.

CAUTION: Do not use force when working on plastic parts. Permanent damage to the part might result.

- 1.** The Six-Gun/EconoMind switch will be installed on the drivers side of the instrument panel (IP) next to the steering column. See **Figure 18**.
- 2.** Remove the headlamp switch bezel on the drivers side by gently pulling on it. Disconnect the electrical connector once the bezel is removed.
- 3.** To remove the center bezel, open the ashtray and cup holder and remove the retaining screw. Gently pull on the center bezel to disengage all the clips that attach the bezel to the dash. Disconnect the four (4) electrical connections after the bezel is removed. Keep the screw for reinstallation.

- 4.** Remove the cluster bezel by first removing the two (2) screws at the top. Gently pull on it and disengage all the clips that attach the bezel to the dash. Retain the screws for reinstallation.

- 5.** Cut out the supplied template (see **Figure 26** on **Page 34**) and align the template onto the front of the cluster bezel by placing its left edge against the cluster rib, and its bottom edge against the cluster bottom edge. Use masking tape to securely hold down the template.

NOTE: Do not tape over the markings on the template.

- 6.** Using a $\frac{3}{8}$ " Uni-drill, center the bit onto the $\frac{3}{8}$ " drill location on the template and slowly drill through the IP. Using a $\frac{1}{8}$ " drill bit, center and drill through the $\frac{1}{8}$ " location on the template. Remove and discard the template and any plastic shavings.

NOTE: It is important that the hole is drilled at the recommended location. The switch may not clear the instrument panel structure if the hole is shifted to another location.

7. Align the Banks Six-Gun/EconoMind label onto the previously drilled hole. Make sure the entire mounting surface is clean and free of dirt and oil before mounting the label. Clean and dry as required using a cloth dampened with rubbing alcohol or similar cleaning solution.

CAUTION: Do not spray fluid directly onto any electrical equipment, or equipment damage may result.

Mount the Six-Gun/EconoMind Diesel Tuner switch label onto the cluster by peeling the protective backing off the adhesive tape on the back of the switch label. Hold the label against the panel for approximately 20 seconds while applying pressure to allow the adhesive to properly adhere to the surface.

8. Remove the nut and internal tooth washer from the Six-Gun/EconoMind switch. Rotate the shaft counter clockwise until the shaft stops. Verify that the locating washer tab is inserted into the #6 position on the switch (see **Figure 19**).

NOTE: If the washer is in any position other than the #6, your Six-Gun/EconoMind Diesel Tuner will not select power levels correctly.

9. After confirming the locating washer is in the #6 location, install the switch through the $\frac{3}{8}$ " hole on the backside of the bezel. The alignment pin should rest in the $\frac{1}{8}$ " hole and with the switch fully rotated counter clockwise; the shaft's flat side should be facing the steering column. Secure switch with internal tooth washer and nut. Snug the nut. Be careful not to over torque the nut and damage the plastic threads.

10. Install the knob onto the shaft facing the #1 Level on the Six-Gun/EconoMind label. On the knob, snug the two (2) set screws with the supplied 0.050" hex key wrench.

11. Reinstall the cluster bezel by pressing on it to ensure all the clips are engaged. Secure it with the original a two (2) screws.

12. Reconnect the electrical connector to the headlamp switch bezel. Reinstall this bezel by gently pushing on it until all clips are engaged.

13. Reconnect the four (4) electrical connections to the center bezel. Reinstall this bezel by pushing on it to engage all the clips. Open the ashtray and cup holder and reinstall the original screw.

14. Route the Six-Gun/EconoMind switch wires down to the steering column.

15. Route the Six-Gun/EconoMind switch's cable to the wire harness that was routed into the passenger compartment from the Six-Gun/EconoMind module, and plug the 2-pin connector into the corresponding connector on the Six-Gun/EconoMind harness.

16. Re-install the electric connector bracket that was removed in Step 5 of Section 1, page 11, below the steering column in the front of the firewall with the original two (2) bolts.

17. Route all wiring away from any pedals or other moving components. Using the cable ties supplied, secure the wiring under the dash. Secure all wiring under the hood away from heat sources or sharp edges. Re-install the lower dash panel with the original 2 bolts.

-END, SECTION 3-

Figure 18

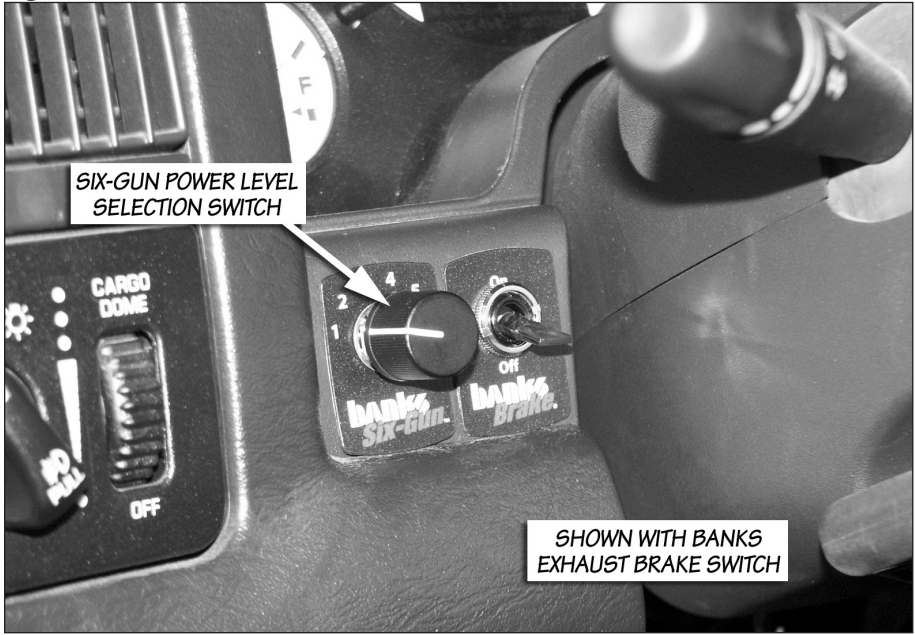
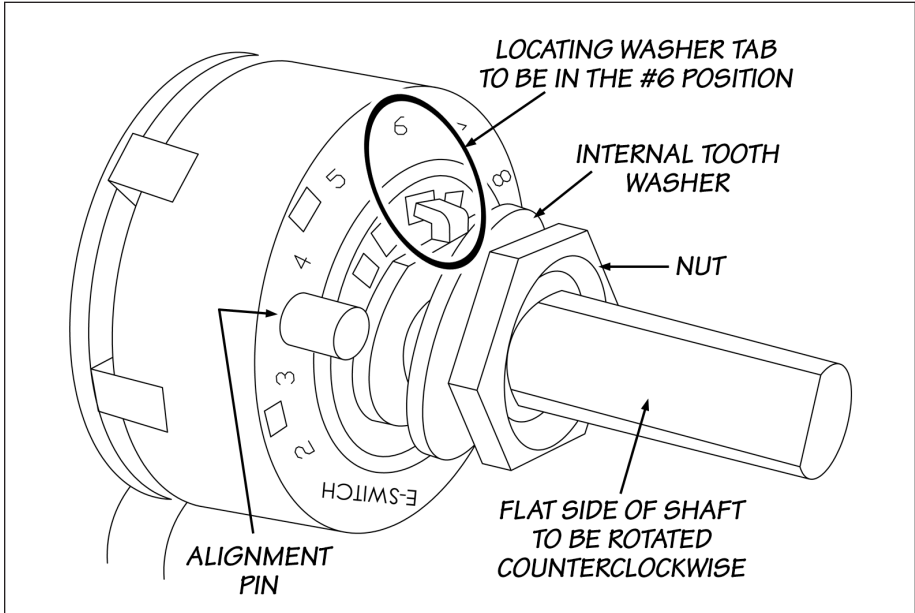

Figure 19 Six-Gun/EconoMind switch, orientation of the tab on the washer



Section 4

OPTIONAL THERMOCOUPLE INSTALLATION

1. The thermocouple monitors the temperature of the exhaust gases entering the turbocharger at the turbine housing. Installation requires that the exhaust manifold be drilled near the outlet of the manifold adjacent to the turbine housing. For this reason it is essential that the turbocharger be removed from the engine in order to clean out any metal chips from drilling that could cause turbine blade damage.

NOTE: The Cummins ISB engine uses a divided exhaust manifold. The thermocouple may be installed to sample exhaust temperature in either exhaust passage. We recommend the rear passage (toward the firewall).

2. Loosen the clamps that attach the air inlet tube to the air filter housing and to the turbocharger, and remove the air inlet tube from the vehicle. Remove the air filter housing from the vehicle. This will allow easier access to the turbocharger.

3. Loosen the upper hose clamp on the turbocharger oil drain-tube hose that is located between the two sections of the oil drain tube.

4. Disconnect the oil supply hose at the turbocharger. Disconnect the compressor outlet hose that goes to the intercooler.

5. Disconnect the turbine outlet pipe by loosening the V-band. Save V-band for re-installation.

6. Remove the turbocharger mounting nuts/bolts and the turbocharger from the exhaust manifold. Clean and inspect the exhaust flange mounting surfaces on the exhaust manifold. Make sure the surface is clean and dry.

CAUTION: Anytime the turbocharger is removed from the engine, take care that no foreign objects enter any of the

turbocharger connections on the engine or the turbocharger. Foreign objects entering air, exhaust, or oil connections may cause major damage to the engine and/or turbocharger and is not covered under any warranty. Cover the open end of the intercooler pipe with a clean rag, as this pipe is very susceptible to foreign object entry.

7. Stuff clean shop towels into the compressor outlet and inlet hoses to prevent contamination from entering the pipes. Cover the turbo oil drainpipe to avoid contamination.

8. Stuff a small clean shop towel or rag 4 to 5 inches into the rear exhaust manifold passage through the turbocharger mounting flange. This is to prevent chips from entering the manifold while drilling and tapping.

9. Use a 7/16" drill, keeping the drill perpendicular to the manifold surface and drill through the exhaust manifold into the rear passage as shown in **Figure 20**.

10. Tap the drilled hole with a 1/4" NPT pipe tap. Check the thread depth as you tap by periodically removing the tap and screwing the pipe coupling into the tapped hole. The coupling should thread in 3 to 3 1/2 turns hand tight. Do not install the probe in place at this time.

11. Remove all loose chips from the exhaust manifold. A shop vacuum or small brush will help. Now remove the rag using a welding rod or coat hanger bent into a hook.

Caution! Make sure rags are removed from exhaust manifold prior to reinstalling turbocharger!

12. Install the thermocouple in the manifold using anti-seize on the threads.

13. Attach the thermocouple to the supplied thermocouple lead wire extension with the supplied nuts and bolts. The YELLOW thermocouple wire attaches to the YELLOW extension wire's, the RED thermocouple wire attaches to the RED extension wire. Cover this joint with the supplied heat shrink tubing and heat until the tubing conforms to the joint. Make sure the entire joint is insulated.

14. Route the thermocouple lead wire extension along the factory harness to the driver's side and connect it to the Six-Gun/EconoMind harness with the supplied nuts and bolts. The YELLOW wire attaches to the free YELLOW wire on the Six-Gun/EconoMind Diesel Tuner. The RED extension wire attaches to the free RED wire on the Six-Gun/EconoMind Diesel Tuner. Cover this joint with the supplied heat shrink tubing and heat until the tubing conforms to the joint. Make sure the entire joint is insulated.

CAUTION: Remove all the rags that are inside the compressor hoses and the exhaust manifold before re-installing the turbocharger.

15. Install the new turbine inlet gasket provided and apply a dab of anti-seize compound to the four turbo mounting studs. Install the turbocharger on the exhaust manifold. As the turbocharger is reinstalled, slip the oil drain tube into the drain hose. Tighten the turbocharger mounting nuts to 24 ft-lbs. Tighten the oil drain

hose clamp.

16. Reconnect and tighten the turbo oil supply hose.

17. Reconnect the turbine outlet pipe to the turbocharger and secure it with the V-band.

18. Re-connect the compressor outlet hose that goes to the intercooler.

19. Re-install the air filter housing that was previously removed.

20. Reconnect the ground cables to the vehicles batteries.

NOTE: Once the Six-Gun/EconoMind Diesel Tuner is powered up at key-on, it will 'learn' that a thermocouple is installed and automatically enable the EGT limiting function.

If the thermocouple is removed after being installed and run on the vehicle, the Six-Gun/EconoMind Diesel Tuner will assume that the sensor or connection has gone bad, and cease adding power while triggering the [2,3] diagnostic code (see Trouble Shooting Section 7). EconoMind Will not function without required thermocouple. -END, SECTION 4-

Section 5

AUTOMATIC TRANSMISSION LEARNING

NOTE: The Six-Gun/EconoMind Diesel Tuner will not add power until it learns what transmission your vehicle is equipped with. Follow steps 1-3, Section 5 for learning process.

Your Six-Gun/EconoMind Diesel Tuner displays the "4,3" diagnostic code (refer to TROUBLESHOOTING in

Section 8 on how to read codes) when it needs to learn your transmission configuration. This always occurs when the Six-Gun/EconoMind Diesel Tuner is first installed on the truck. The Six-Gun/EconoMind Diesel Tuner is equipped with advanced safety features to preserve your automatic transmission. One of them is the capability to detect the occurrence of transmission slip, and it will automatically de-rate the engine output power accordingly.

Figure 20

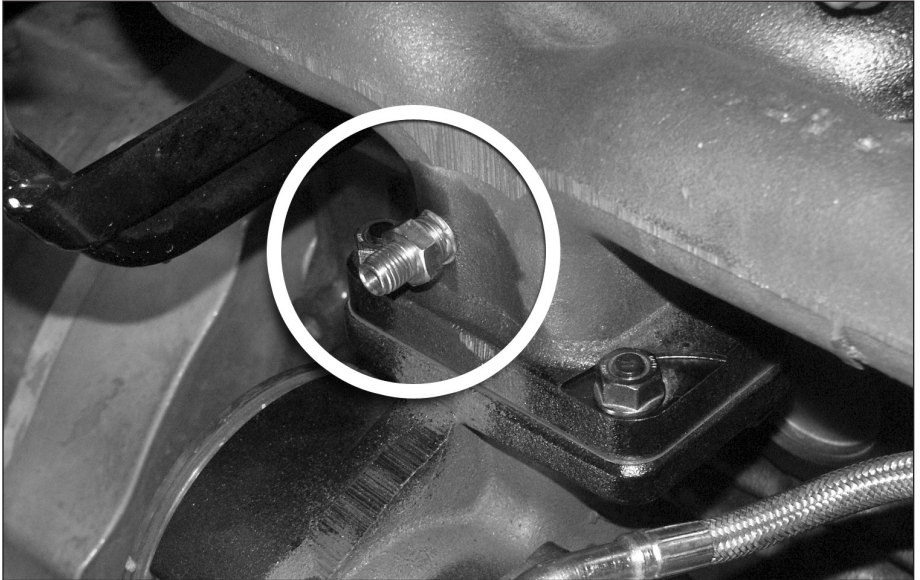

Before this safety feature can take effect, the Six-Gun/EconoMind Diesel Tuner needs to learn that your truck is equipped with an automatic transmission. (Please read the "Disclaimer of Liability" on page 4.)

1. The following driving test shall be performed in an area where speeds over 55mph are safe and traffic is light. For a vehicle with a manual transmission, follow **Step 2**. For a vehicle with an automatic transmission, follow **Step 3**. While driving, listen for any exhaust leaks or rattles, or intake boost leaks. After the engine cools, re-tighten clamps and hoses if leaks are detected.

2. (Manual trans) To teach the Six-Gun/EconoMind Diesel Tuner that your truck is equipped with a manual transmission drive the truck at a speed over 55 mph for at least 2 minutes. The "4,3" diagnostic code will be eliminated. Repeat if necessary to

eliminate code. Proceed to **Section 6**.

3. (Auto Trans) To teach the Six-Gun/EconoMind Diesel Tuner that your truck is equipped with an automatic transmission drive the truck at a speed over 55mph until the torque converter is locked (the torque converter is usually locked at speeds over 55mph). With the torque converter locked and with turbo boost below 10psig (ie, light load), maintain the attained speed steadily for at least 30 seconds. Once the transmission is learned, the "4,3" diagnostic code will be eliminated. Repeat if necessary to eliminate code.

-END, SECTION 5-

Section 6

CHECKING ENGINE PERFORMANCE

The Six-Gun/EconoMind Diesel Tuner requires the engine coolant temperature (ECT) to be above 120° before it will add fuel. If the optional Banks iDash or DynaFact® gauges are installed, observe the operation of the boost and pyrometer (EGT) gauge values while driving under varying conditions. Turbocharger boost pressure will increase as a function of load and engine RPM, thus the engine will produce little boost while cruising at light throttle, with maximum boost while climbing hills heavily loaded during acceleration. Note the boost level seen during hard acceleration with a given load. If performance seems to have deteriorated sometime in the future, the maximum boost figures may be compared to see if boost has dropped off. Lower boost may be caused by turbo ducting leaks, a malfunctioning wastegate or fuel injection pump, or dirty air filter. Typical maximum boost pressure settings will vary considerably with stick or automatic transmission options, year model of vehicle and altitude. *NOTE: Before key-off, check tuner for error codes.*

Use your Banks iDash or EGT gauge to

monitor exhaust gas temperature (EGT) in the engine. At idle, exhaust gas temperature will be very low, perhaps only 300°F. As the engine is accelerated for higher speeds with greater loads, the EGT will rise. The highest EGT will be seen under maximum load at full throttle, such as climbing a steep grade with a heavily laden vehicle.

To avoid heat damage to various engine components it is recommended that the exhaust gases cool below 400° before the engine is shut down. When EGT Temperature Limit Kit/Thermocouple installed, your Six-Gun/EconoMind Diesel Tuner is calibrated to maintain a maximum EGT of 1350°F on levels 2-5 (2-6 with EconoMind). You may experience brief excursions slightly above 1350°F under acceleration. This is normal and EGT should return to 1350°F or below within a few seconds. **⚠ CAUTION: Level 6 EGT limit set at 1500° F.** If you find that EGT remains high for any length of time, check for boost leaks or a dirty air filter.

-END, SECTION 6-

Section 7

TROUBLESHOOTING

 **FOR IDASH 1.8 INSTRUCTIONS, SEE IDASH 1.8 MANUAL 97654 & 97674**

SIX-GUN/ECONOMIND TROUBLESHOOTING WITHOUT THE BANKS iDash

Your Six-Gun/EconoMind Diesel Tuner is equipped with diagnostic features that will detect and display certain errors. Remove the Six-Gun Diesel Tuner from its mounting location while keeping all connectors plugged in. Turn the vehicle key to the ON position. Observe the two LEDs mounted on the end of the Six-Gun/EconoMind Diesel Tuner, next to the harnesses.

If all wire connections are correct, a steady GREEN LED is illuminated. If the GREEN LED is not illuminated when the ignition is ON, check power supply hookup and the fuse on the Six-Gun/EconoMind main wire harness. If the connections and fuse are okay, contact Banks Technical Service. If a connection is incorrect or if there is a problem with the system, when the ignition is ON the RED LED will flash in sequence to identify a diagnostic code. A Six-Gun/EconoMind Diesel Tuner's diagnostic code is comprised of 2 digits. Each code is expressed in a sequence of 2 sets of the flashing RED LED separated by a brief flashing of the GREEN LED in between. Each set of a number of RED LED flashes represents a digit. A longer flashing of the GREEN LED separates the sequences. The LEDs will continue to flash to display all the errors, and then repeat. Table 1 lists the available diagnostic codes and their commended course of action for each.

For example, if a faulty thermocouple is detected (code "2,3") by the Six-Gun/EconoMind Diesel Tuner, the following RED and GREEN LED flashing sequence is observed when the ignition is ON:

- (1) Two times flashing RED LED
 - (2) One time quick flashing GREEN LED
 - (3) Three times flashing RED LED
 - (4) One time longer flashing GREEN LED
- The above flashing sequence will repeat continuously. When the problem is corrected, the diagnostic code will be eliminated and replaced by a steady GREEN LED.

NOTE: If multiple codes are set, they will be displayed in a series separated by the longer flashing GREEN LED. When reading codes, make sure to watch the entire series until you see the first code repeat.

NOTE: The "4,3" code comes on when the Six-Gun/EconoMind Diesel Tuner module is first installed on a vehicle. To eliminate this code, follow the instructions described in "Transmission Learning" (Section 6). If problem persists, contact Banks Technical Service.

If the Six-Gun/EconoMind Diesel Tuner should ever need to be removed from the vehicle, all vehicle connectors must be reconnected to their stock configuration. Failure to reconnect the vehicle may result in a "Check Engine" light on the dash and a Diagnostic Trouble Code being stored in the factory computer, and the engine may not start. -END, SECTION 7-

of 2 digits. Each code is expressed in a sequence of 2 sets of the flashing RED LED separated by a brief flashing of the GREEN LED in between. Each set of a number of RED LED flashes represents a digit. A longer flashing of the GREEN LED separates the sequences. The LEDs will continue to flash to display all the errors, and then repeat. Table 1 lists the available diagnostic codes and their recommended course of action for each. For example, if a faulty thermocouple is detected (code "2,3") by the Six-Gun/EconoMind Diesel Tuner, the following RED and GREEN LED flashing sequence is observed when the ignition is ON:

- (1) Two times flashing RED LED
- (2) One time quick flashing GREEN LED
- (3) Three times flashing RED LED
- (4) One time longer flashing GREEN LED. The above flashing sequence will repeat continuously. When the problem is corrected, the diagnostic code will be eliminated and replaced

by a steady GREEN LED.

NOTE: If multiple codes are set, they will be displayed in a series separated by the longer flashing GREEN LED.

When reading codes, make sure to watch the entire series until you see the first code repeat.

NOTE: The "4,3" code comes on when the Six-Gun/EconoMind Diesel Tuner module is first installed on a vehicle. To eliminate this code, follow the instructions described in "Transmission Learning" (Section 6). If problem persists, contact Banks Technical Service.

If the Six-Gun/EconoMind Diesel Tuner should ever need to be removed from the vehicle, all vehicle connectors must be reconnected to their stock configuration. Failure to reconnect the vehicle may result in a "Check Engine" light on the dash and a Diagnostic Trouble Code being stored in the factory computer, and the engine may not start. -END, SECTION 7-

Table 1 Banks Six-Gun/EconoMind Fault Codes

Code	Event	Course of Action
1,1	Fuel Rail Pressure (FRP) Input Voltage Out of Range.	Turn ignition OFF and check 3-pin FRP sensor connections. Turn ignition back ON and re-check for presence of code. If problem persists, call Gale Banks Engineering Tech Support.
1,2	Manifold Absolute Pressure (MAP) Input Voltage Out of Range.	Turn ignition OFF and check 4-pin MAP sensor connections. Turn ignition back ON and re-check for presence of code. If problem persists, call Gale Banks Engineering Tech Support.
1,3	Six-Gun/EconoMind Switch Input Value Out of Range.	Turn ignition OFF and make sure either Banks IQ or Six-Gun/EconoMind switch is connected to Six-Gun/EconoMind tuner. If Six-Gun/EconoMind switch is connected (no Banks IQ), check 2-pin connection on tuner's in-cab cable. Turn ignition back ON and re-check for presence of code. If problem persists, call Gale Banks Engineering Tech Support.
1,4	SCI Communications Error With Vehicle.	Turn ignition OFF and check in-cab OBD II and 8-pin cable connections. Turn ignition back ON and re-check for presence of code. If problem persists, call Gale Banks Engineering Tech Support.
2,1	Fuel Rail Pressure (FRP) Output Voltage Out of Range.	Turn ignition OFF and check 3-pin FRP sensor connections. Turn ignition back ON and re-check for presence of code. If problem persists, call Gale Banks Engineering Tech Support.
2,2	Manifold Absolute Pressure (MAP) Output Voltage Out of Range.	Turn ignition OFF and check 4-pin MAP sensor connections. Turn ignition back ON and re-check for presence of code. If problem persists, call Gale Banks Engineering Tech Support.
2,3	Exhaust Gas Temperature (EGT) Sensor Open Circuit or Out of Range.	Turn ignition OFF and check thermocouple ring-terminal connections (2). If not utilizing Thermocouple connect eyelets on red & yellow wires together. NOTE: Temp limit feature will be disabled. Turn ignition back ON and re-check for presence of code. If problem persists, call Gale Banks Engineering Tech Support.
2,4	J1850 Communications Error With Vehicle.	Turn ignition OFF and check in-cab OBD II and 8-pin cable connections. Turn ignition back ON and re-check for presence of code. If problem persists, call Gale Banks Engineering Tech Support.
3,1	Crankshaft Position (CKP) Signal Fault or Intermittent Power.	Turn ignition OFF and check 3-pin CKP and CMP sensor connections and fuse-tap power connection to Six-Gun/EconoMind tuner (in engine compartment fuse box). Start engine and re-check for presence of code. If problem persists, call Gale Banks Engineering Tech Support.
3,2	Internal Module Malfunction.	Turn ignition OFF and check all Six-Gun/EconoMind tuner connections. Turn ignition back ON and re-check for presence of code. If problem persists, call Gale Banks Engineering Tech Support.
3,3	Low Battery Voltage or Internal Module Malfunction.	Turn ignition OFF and check fuse-tap power connection to Six-Gun/EconoMind tuner (in engine compartment fuse box). Turn ignition back ON and re-check for presence of code. If problem persists, call Gale Banks Engineering Tech Support.
4,2	Transmission Slippage Detected.	Transmission is slipping excessively. Code will automatically clear once transmission stops slipping (repaired).
4,3	Unlearned Transmission Type and Gear Ratios.	Perform Transmission Learning procedure in Section 6. Code will automatically clear once transmission type and gear ratios (auto trans. only) have been learned successfully. If problem persists, call Gale Banks Engineering Tech Support.
4,4	Engine Rating Changed or Not Learned.	Turn ignition ON and allow Six-Gun/EconoMind to learn engine rating (approx. 10 seconds). If Six-Gun/EconoMind has been moved to a different truck and engine platform, perform steps 1-4 on page 32 of Section 8. If problem persists, call Gale Banks Engineering Tech Support.

Section 8

CLEARING LEARNED INFORMATION

This procedure should only be performed if:

- A "4,2" code for transmission slip detection is repeatedly set or will not clear and the transmission is not actually slipping; or
- The Six-Gun/EconoMind Diesel Tuner is moved to a new vehicle; or
- The vehicle's speedometer has been factory recalibrated for different gearing or tire size; or
- Instructed to do so by Banks Technical Staff. Your Six-Gun/EconoMind Diesel Tuner also has the capability to clear the information related to the learned transmission type and gear ratios. The diagnostic code "4, 3" will reappear after the procedures are carried out correctly. Follow the steps below to unlearn the transmission on your Six-Gun/EconoMind Diesel Tuner.

CAUTION: The following procedures can only be carried out with the engine not running.

- 1.** Turn the vehicle key to the ON position but DO NOT start the engine.
- 2.** Fully depress the accelerator pedal and then release it completely. Repeat for 5 times. The GREEN LED will flash when this is completed successfully.
- 3.** Turn the key OFF. Wait 10 seconds, or until the GREEN LED goes off and stays off. Turn the key to the ON position but DO NOT start the engine.
- 4.** Fully depress the accelerator pedal and then release it completely. Repeat for 5 times. The "4,3" diagnostic code will flash when this is completed successfully.

NOTE: When the transmission type and gear ratios are cleared (with code "4,3" displayed), the engine power returns and remains in stock level until the Six-Gun/EconoMind Diesel Tuner re-learns the transmission and the "4,3" code is eliminated. Follow the procedures in "Transmission Learning" (Section 6) to eliminate the "4,3".

-END, SECTION 8-

Section 9

PLACEMENT OF THE BANKS POWER DECALS

Figure 25

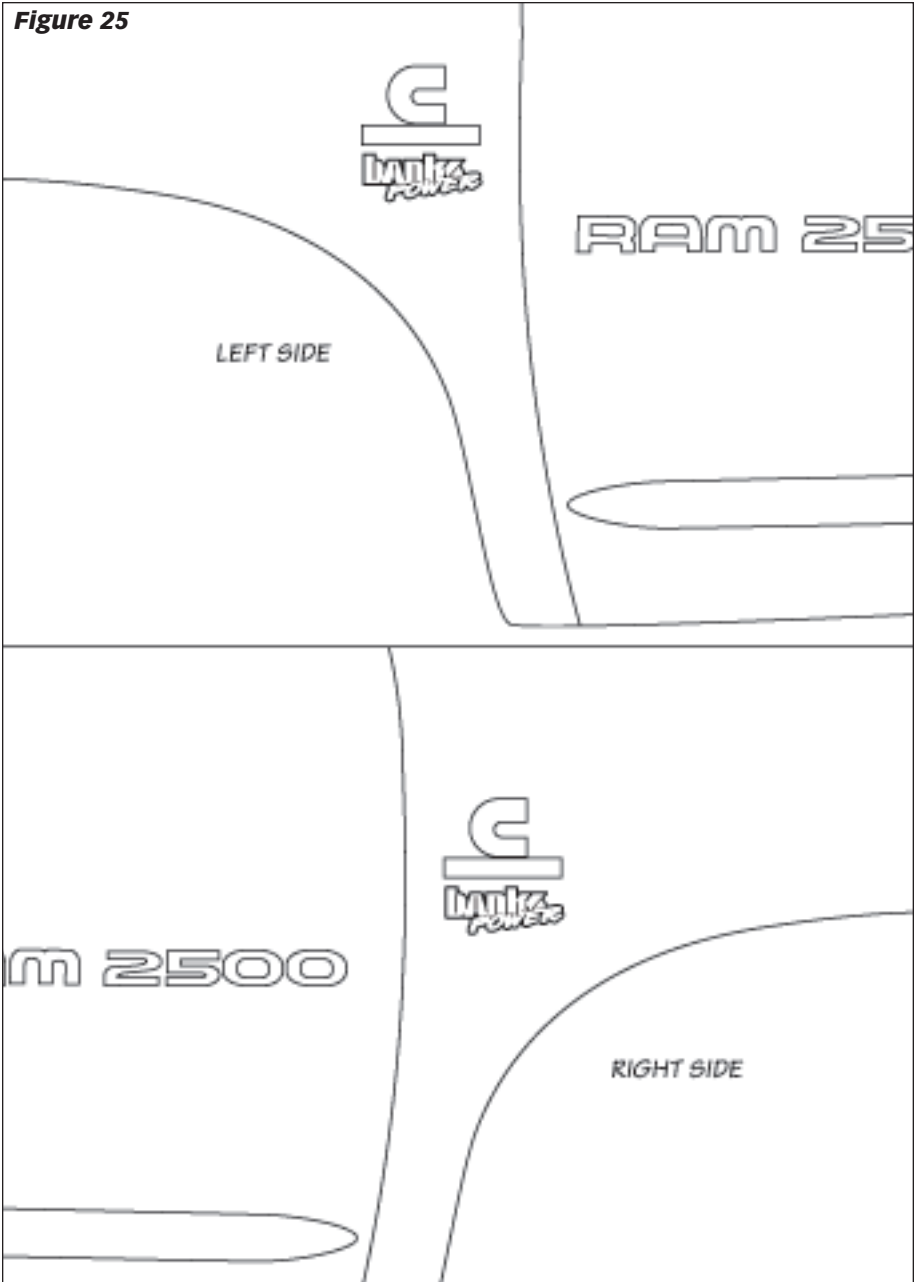

-END, SECTION 9-

Section 10

REMOVAL OF THE SIX-GUN/ECONOMIND DIESEL TUNER

If the Six-Gun/EconoMind Diesel Tuner should ever need to be removed from the vehicle, perform the following:

1. Disconnect the Six-Gun/EconoMind's Fuel Rail Pressure (FRP) connections from the vehicle's FRP sensor and harness.
2. Re-connect the vehicle's FRP connector back into the FRP sensor.
3. Disconnect the Six-Gun/EconoMind's Manifold Absolute Pressure (MAP) connections from the vehicle's MAP sensor and harness.
4. Re-connect the vehicle's MAP connector back into the MAP sensor.
5. Disconnect the Six-Gun/EconoMind's Crankshaft Position (CKP) connections from the vehicle's CKP sensor and harness.
6. Re-connect the vehicle's CKP connector back into the CKP sensor.
7. Disconnect the Six-Gun/EconoMind's Camshaft Position (CMP) connections from the vehicle's CMP

sensor and harness.

8. Re-connect the vehicle's CMP connector back into the CMP sensor.

9. Unplug the Six-Gun/EconoMind's RED/WHT power wire from the mini-fuse tap and remove the tap.

10. Disconnect the 2 ring terminals nearest the Six-Gun/EconoMind from the EGT thermocouple lead wire.

11. Disconnect the 3 small connectors on the Six-Gun/EconoMind's in-cab cable and gently pull the cable back through the firewall.

12. Remove the Six-Gun/EconoMind Diesel Tuner.

NOTE: Failure to follow the above instructions when removing the Six-Gun/EconoMind Tuner will result in a "Check Engine" light on the dash and a Diagnostic Trouble Code being stored in the factory computer, in addition to the engine not running.

-END, SECTION 10-

Figure 26

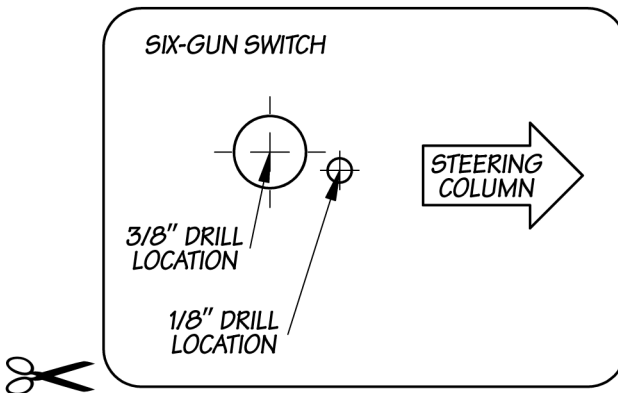

Owner's Manual with Installation Instructions

iDash[®] 1.8 for Banks Bus 1 Quick Start Guide

**Banks Six-Gun, Economind Tuner
and SpeedBrake vehicles.**

THIS MANUAL IS FOR USE WITH SYSTEM 61401, 61402, 61403, & 61404



**For more information:
Bankspower.com/iDash**



For iDash 4.3/5.0 replacement only:

1. Uninstall the Banks IQ, Banks Bridge Module, and the OBD-II cable (for the Banks IQ Bridge Interface).

See Figure 1 & 2.

For all installations:

2. Connect the OBD-II Cable for the iDash 1.8" (see Figure 2) to your vehicle's OBD-II port.

NOTE: For Motorhomes, skip step 2

3. Connect the 6-Pin/8-Pin (Application Dependant) of the OBD-II Cable to the Power Tuner/ SpeedBrake.

4. Connect the 4-Pin connector of the OBD-II Cable to the iDash 1.8" (See Figure 2).

Ford 6.0 Power Stroke Applications

For any OBD-II Cable for the Ford 6.0L (See Figure 4), a connection has to be made to the fuse panel (Fuse #22) using a fuse tap.

- Remove the Panel to reveal the fuse panel below the steering wheel and remove **Fuse #22**. See Figure 3.
- Apply the provided fuse tap before reinstalling. See Figure 4
- Route the female terminator connector to the fuse tap. See Figure 4

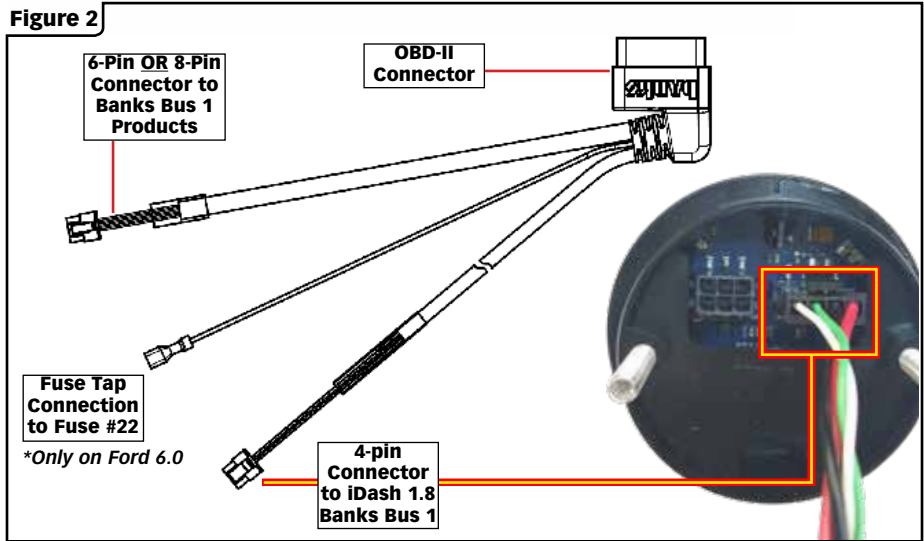
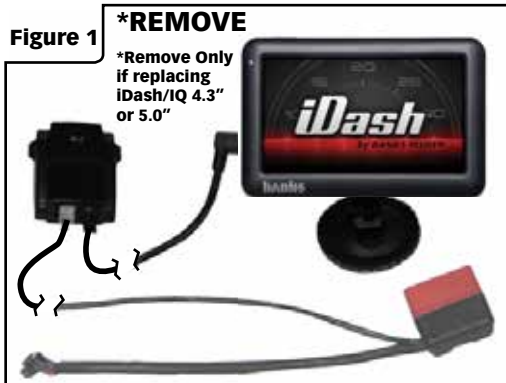

If installing multiple iDash 1.8".

A. Remove any extra terminators. Only one is needed for all iDash 1.8" connected. **See Figure 5, Step A.**

B. Use Y- Cable(s) to connect all the iDash 1.8". **See Figure 5, Step B.**

Refer to the iDash 1.8" Installation manual for more detailed instructions on iDash 1.8" install.

Figure 5

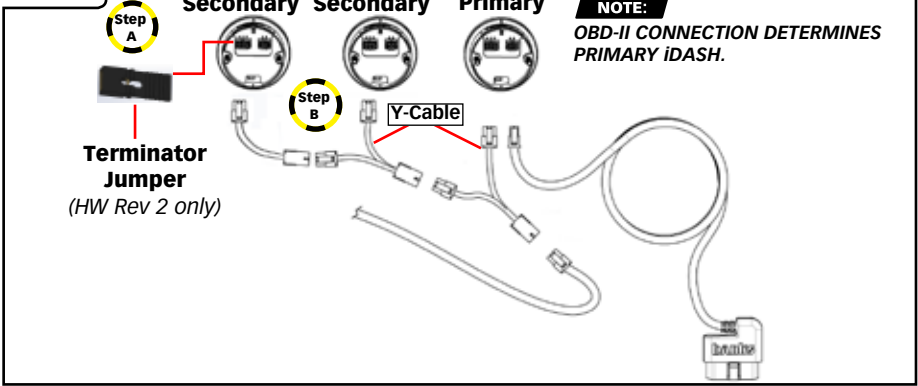

iDash Button Function

UP button

Hold to... :
- Rapid scroll
(Value Selection)

SELECT button

Hold to... :
- Save and return
to Gauge Screen



DOWN button

Hold to... :
- Rapid scroll
(Value Selection)
- Start/Stop
(Datalog Mode)

BACK button

Press to... :
- Create Laps/
Markers
(Data Log Mode)
Hold to... :
- Return to Gauge
Screen

SixGun and EconoMind Setup

To load the Tuner layout navigate to:

- **Menu -> Gauge Layout -> Tuner -> *Select***

To change power level:

- Press the **up** or **down** arrow.

PRESS to increase power level.

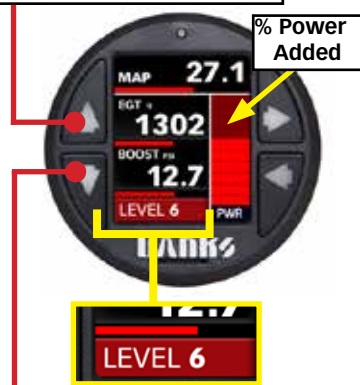

PRESS to decrease power level.

SpeedBrake Setup

- To load the SpeedBrake layout navigate to:

Menu -> Gauge Layout -> SpeedBrake -> *Select*

- To switch between SpeedBrake modes press and hold the **up** button for 2 seconds.

SpeedBrake Manual Mode:

- Press the **up** and **down** button to switch between low, medium and high settings.
- To enable/disable the "Foot Brake" navigate to:

**Menu -> Banks Modules-> SpeedBrake -> FootBrake:
-> *Select***

HOLD to change SpeedBrake Mode
PRESS to change SpeedBrake Strength



PRESS to change SpeedBrake Strength

SpeedBrake Auto Mode:

- Press the **up** and **down** button to adjust the speed set point in increments of 5 mph (from 25-75)

HOLD to change SpeedBrake Mode
PRESS to change Speed Setting



PRESS to change Speed Settings

Tuner / SpeedBrake Auto Switch:

- The "Tuner Auto Switch" feature allows you to have the "Tuner" layout and "SpeedBrake" layout switch automatically while driving.

See section 12 of iDash 1.8 Owner's Manual **97654** for more details.

Trouble Shooting Note:

- If you do not have any communication with the Tuner or SpeedBrake (RPM is always "--") go to:

Menu-> Settings-> Vehicle Selection-> Banks Bus 1 Application -> *Select*