

banks

with Installation Instructions

Owner's Manual

Banks Six-Gun® Diesel Tuner

Compatible with Optional Banks iQ™

**2001-2005 Chevy/GMC 6.6L Duramax
Turbo-Diesel Pickups**

THIS MANUAL IS FOR USE WITH SYSTEMS

63717, 63767, 63729, 63739

Products available from Banks Power for the 2001-2005 CHEVY/GMC - 6.6L

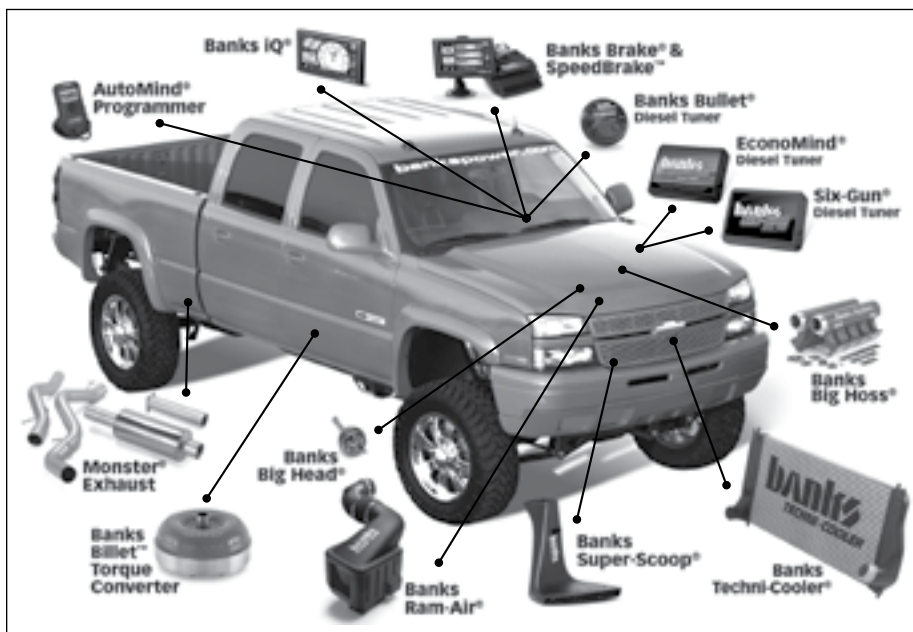

Six-Gun® Diesel Tuner & Banks iQ® 2.0 (P/N 63729, 63739)

- Controls Banks diesel tuner and/or SpeedBrake™
- Big 5" full-color touch-screen display
- Interchangeable gauge display – change screens/colors
- Read & Clear Codes
- 1/4, 1/8 mile & 0-60 performance testing
- Multi-media playback (music, video games, pictures)
- View your Microsoft® Office documents on the go...and much more!

Six-Gun® Diesel Tuner & switch (P/N 63767, 63717, 64507)

- Destroys the competition, not your vehicle!
- CleanTune® Technology
- Change-on-the-fly power (includes fuel economy level)
- 0-60 mph in 1/3 less distance!

- ActiveSafety® protects engine & powertrain
- Touch-screen Vehicle Command Center
- 1/4, 1/8 mile & 0-60 performance testing
- Multi-media playback (music, video games, pictures)
- View your Microsoft® Office documents on the go...and much more!

EconoMind® Diesel Tuner & Banks iQ® 2.0 (P/N 63727, 63728, 63737, 63738)

- Controls Banks diesel tuner and/or SpeedBrake™
- Big 5" full-color touch-screen display
- Interchangeable gauge display – change screens/colors
- Read & Clear Codes
- 1/4, 1/8 mile & 0-60 performance testing
- Multi-media playback (music, video

games, pictures)

- View your Microsoft® Office documents on the go...and much more!

EconoMind® Diesel Tuner & switch (P/N 63763, 63765, 63713, 63715)

- Tunes pulse width, timing & fuel pressure
- CleanTune® Technology
- Better fuel economy under any load
- 20% faster hillclimbs, in a higher gear
- Up to 19% more MPG
- ActiveSafety® protects engine/powertrain

Banks Bullet® (P/N 636516, 66517) ('01-'04 only)

- Value priced, yet loaded with features
- STOCK, TOW, SPORT power levels
- EGT* & Boost gauge
- Displays critical engine functions
- Set temp limit & save your engine with optional thermocouple

Banks iQ® 2.0 (P/N 61141, 61142)

- Controls Banks diesel tuner and/or SpeedBrake™
- Big 5" full-color touch-screen display
- Interchangeable gauge display – change screens/colors
- Read & Clear Codes
- 1/4, 1/8 mile & 0-60 performance testing
- Multi-media playback (music, video games, pictures)
- View your Microsoft® Office documents on the go...and much more!

AutoMind® Programmer (P/N 66104)

- Adjust or remove the engine rev limiter and/or top speed limiter
- Speedometer calibration based on tire size and/or gear ratio
- Adjust the cooling fan activation

temperature

- Adjust shift points and/or shift firmness
- Includes a fuel economy calibration
- Reads and clear trouble codes
- Internet updateable

Big Hoss® Bundle (P/N 47712-47729, 47737-47742) Includes:

- Monster® Diesel Duals Exhaust
- Banks Ram-Air® Intake System
- Six-Gun® Diesel Tuner & Banks iQ® 2.0
- Monster Muffler
- BigHead® Wastegate Actuator
- Techni-Cooler® Intercooler System

Six-Gun® Bundle (P/N 47700-47711, 47731-47736) Includes:

- Monster® Diesel Duals Exhaust
- Banks Ram-Air® Intake System
- Six-Gun® Diesel Tuner & Banks iQ® 2.0
- Monster Muffler
- BigHead® Wastegate Actuator

PowerPack® System (P/N 48963-48980, 48989-48994) Includes:

- Monster® Diesel (Single or Duals) Exhaust
- Banks Ram-Air® Intake System
- EconoMind® Diesel Tuner & Banks iQ® 2.0
- Monster Muffler
- BigHead® Wastegate Actuator
- Techni-Cooler® Intercooler System

Stinger® System (P/N 48950-48961, 48982-48987) Includes:

- Monster® Diesel (Single or Duals) Exhaust
 - Banks Ram-Air® Intake System
 - EconoMind® Diesel Tuner & Banks iQ® 2.0
 - Monster Muffler
 - BigHead® Wastegate Actuator
-

**Banks Ram-Air® Intake System
(P/N 41518, 42132, 42135, 42138,
42142, 90092, 90093)**

- Extensively tested & validated
- Increases power & fuel economy
- Reduces exhaust gas temps (EGTs) & smoke
- Outflows stock & competitors up to 57%
- Optional Super-Scoop® rams cold air for more power

**Banks Super-Scoop® (P/N 42168,
42169)**

- More Power & MPG
- Forces charge of cool, pressurized ram air into filter housing
- Optimizes Ram-Air Intake efficiency for more power

**Techni-Cooler® Intercooler System
(P/N 25976, 25977, 25978)**

- Packs cool, dense air into the cylinders
- Lower restriction for superior flow
- 25% thicker core with 34% more volume
- Big boost tubes & durable cast end tanks
- Cooler EGTs + more MPG & continuous power

**SpeedBrake™ (P/N 55419, 55437,
55440) ('04-'05 only)**

- All-electronic design with exclusive Speed Control
- User-selectable downhill speed (25-75 mph) is automatically maintained
- Basic braking function is far superior to conventional exhaust brakes
- Cuts downhill speed up to 78%
- Plug-&-play install; no cutting or welding

**Banks Brake® (P/N 55232, 55233,
55246, 55447)**

- Superior Exhaust Braking
- Computer-controlled exhaust brake maximizes braking power
- Cuts downhill speed up to 52% without use of wheel brakes

- Keeps brakes cool & ready for emergencies
- Saves thousands in brake maintenance!

**Monster® Diesel Duals Exhaust
(P/N 48670-48675, 48942-48946)**

- 100% stainless, not aluminized!
- Doubles the flow; virtually no backpressure
- Huge polished ob-round rolled-edge tips
- Muffler's expansion chamber cuts the drone
- Perfect fit; no spare tire relocation required

**Monster® Exhaust (P/N 48628,
48629, 48630, 48632, 48633, 48634)**

- 100% stainless, not aluminized!
- Improves flow up to 176%; virtually no backpressure
- Giant polished rolled-edge tip
- Muffler's expansion chamber cuts the drone
- A perfect fit

**Monster® Sport Exhaust (P/N
48769, 48770, 48771, 48778)**

- 4" constant-diameter cat-back exhaust system
- Virtually eliminates backpressure & nearly triples flow!
- Lowers exhaust gas temps
- Straight-through Monster Muffler delivers a commanding exhaust note
- 100% Stainless Steel
- Easy install
- 5" rolled-edge polished tip is optional
- Fully compatible with the Chevy/GMC factory warranty
- 5-Year Limited Warranty

**Banks Billet™ Torque Converter
(P/N 72510)**

- Triples Torque Capacity
 - Tough enough for racing
 - Non-slip three-friction-element clutch system
 - Triples stock's torque capacity
 - Lowers trans fluid temps
-

- Improves acceleration

BigHead® Wastegate Actuator (P/N 24396)

- Quick, Controlled Boost
- Doubles stock's diaphragm area & spring pressure
- Produces massive torque right from idle
- Achieves higher peak boost sooner
- More mid-range muscle

Big Hoss® Intake Manifold (P/N 42733)

- Pure Race Capability. Part of the Banks Racing product line; the only purpose-built cast manifolds created for a Duramax. Provides tremendous flow and uniform air distribution.



THIS IS A HIGH PERFORMANCE PRODUCT. USE AT YOUR OWN RISK.

Do not use this product until you have carefully read the following agreement.

This sets forth the terms and conditions for the use of this product. The installation of this product indicates that the BUYER has read and understands this agreement and accepts its terms and conditions.

Disclaimer of Liability

Gale Banks Engineering Inc., and its distributors, employees, and dealers (hereafter "**SELLER**") shall in no way be responsible for the product's proper use and service. The **BUYER** hereby waives all liability claims.

The **BUYER** acknowledges that he/she is not relying on the **SELLER's** skill or judgment to select or furnish goods suitable for any particular purpose and that there are no liabilities which extended beyond the description on the face hereof and the **BUYER** hereby waives all remedies or liabilities, expressed or implied, arising by law or otherwise, (including without any obligations of the **SELLER** with respect to fitness, merchantability, and consequential damages) whether or not occasioned by the **SELLER's** negligence.

The **BUYER** is responsible to fully understand the capability and limitations of his/her vehicle according to manufacturer specifications and agrees to hold the **SELLER** harmless from any damage resulting from the failure to adhere to such specifications.

The **SELLER** disclaims any warranty and expressly disclaims any liability for personal injury or damages. The

BUYER acknowledges and agrees that the disclaimer of any liability for personal injury is a material term for this agreement and the **BUYER** agrees to indemnify the **SELLER** and to hold the **SELLER** harmless from any claim related to the item of the equipment purchased. Under no circumstances will the **SELLER** be liable for any damages or expenses by reason of the use or sale of any such equipment.

The **BUYER** is responsible to obey all applicable federal, state, and local laws, statutes, and ordinances when operating his/her vehicle, and the **BUYER** agrees to hold **SELLER** harmless from any violation thereof.

The **SELLER** assumes no liability regarding the improper installation or misapplication of its products. It is the installer's responsibility to check for proper installation and if in doubt, contact the manufacturer.

The **BUYER** is solely responsible for all warranty issues from the automotive manufacturer.

WARNING: Below 32°F (0°C) or above 140°F (60°C), the Banks iQ may be susceptible to damage as a result of extended direct exposure to sunlight, heat or extreme cold. It is highly recommended that Banks iQ be removed from its mounting location if the vehicle will be subjected to high concentrations of sunlight, heat or cold for an extended period of time. Gale Banks Engineering is not responsible for damage to Banks iQ resulting from exposure conditions.

Under no circumstance shall the **SELLER** be liable for any labor charged or travel time incurred in diagnosis for defects, removal, or reinstallation of this product, or any other contingent expense.

Under no circumstances will the **SELLER** be liable for any damage or expenses incurred by reason of the use or sale of any such equipment.

In the event that the buyer does not agree with this agreement:

The buyer may promptly return this product, in a new and unused condition, with a dated proof-of-purchase, to the place-of-purchase within thirty (30) days from date-of-purchase for a full refund, less shipping and/or restocking fee.

The installation of this product indicates that the buyer has read and understands this agreement and accepts its terms and conditions.

Table of Contents

General Installation Practices

Section 1

Installation of Wiring Harness, Connections and Six-Gun Diesel Tuner

Section 2

Mounting and Connecting the Banks iQ

Section 3

Installation of the Six-Gun Selector Switch

Section 4

Optional Thermocouple Installation (Required for Optional Banks iQ)

Section 5

Automatic Transmission Learning

Section 6

Checking Engine Performance

Section 7

Troubleshooting

Section 8

Clearing Learned Information

Section 9

Placement of the Banks Power Decals

Section 10

Removal of the Six-Gun Diesel Tuner

Dear Customer,

If you have any questions concerning the installation of your Banks Six-Gun Diesel Tuner, please call our Technical Service Hotline. If you have any questions relating to shipping or billing, please contact our Customer Service Department.

Thank you.

The Banks Six-Gun Diesel Tuner has six power levels that you can adjust with either the Six-Gun switch (supplied) or the optional Banks iQ (sold separately).

Banks iQ is a versatile device that gives you total control of your Banks Six-Gun Tuner. With a touch of your finger on the bright, full-color LCD display, you can adjust power parameters, set system warnings and alerts, see vital engine functions at a glance, and more. Evaluate your changes by running 0-60, 1/4, and 1/8 mile performance tests. You can even scan, read and clear OBD II diagnostic trouble codes.

Banks iQ doesn't stop there. It's a true in-car PC packed full of extra functions. Listen to your favorite tunes, watch videos, play games, review Windows® Office documents, and more. Expandable and upgradeable, it comes fitted with a rechargeable battery and includes accessory cords. You'll quickly discover Banks iQ is the device you'll use every day, both inside and outside your car.

The Six-Gun Diesel Tuner comes with a

Six-Gun switch that has six selectable power levels. The Six-Gun switch is included in the Six-Gun Diesel Tuner. Level 1 is stock. Each additional higher level adds approximately 20% of the available power increase.

To prevent damage to the factory transmission, Banks recommends that both automatic and manual transmission vehicles do not exceed Level 4 while the vehicle is experiencing load (towing, climbing a steep grade, carrying a load, etc.).

To use the higher levels of the Six-Gun Diesel Tuner while towing or climbing, airflow improvements must be made to lower the exhaust gas temperature (EGT) entering the turbo. The EGT should not exceed 1400° F for more than a few seconds. Elevated EGT can damage the turbocharger and the engine.

ATTENTION! Before proceeding with these instructions, please carefully read the DISCLAIMER OF LIABILITY and LIMITATION OF WARRANTY statement located on page 4 of this manual.

General Installation Practices

TOOLS REQUIRED:

- Inch and metric sockets
- Inch and metric combination and open-end wrenches
- Pliers
- Wire cutters
- Scissors
- Drill motor
- 1/8" drill bit
- 13/32" drill bit
- 7/16" drill bit
- Tap handle
- 1/4" NPT tap
- Foot-pound torque wrenches
- Penetrating oil or light lubricant spray
- Anti-seize compound
- Heat gun

1. Before starting work, familiarize yourself with the installation procedure by reading all of the instructions.

2. The exploded views provide only general guidance. Refer to each step and section diagram in this manual for proper instruction.

3. Throughout this manual, the left side of the vehicle refers to the driver side, and the right side to the passenger side.

4. Disconnect the negative (ground) cable from the battery (or batteries, if there are two) before beginning work.

5. Route and tie wires and hoses a minimum of 6" away from exhaust heat, moving parts and sharp edges. Clearance of 8" or more is recommended where possible.

6. When raising the vehicle, support it on properly weight-rated safety stands, ramps or a commercial hoist.

Follow the manufacturer's safety precautions. Take care to balance the vehicle to prevent it from slipping or falling. When using ramps, be sure the front wheels are centered squarely on the topsides. When raising the front of the vehicle, put the transmission in park (automatic) or reverse (manual), set the parking brake, and block the rear wheels. When raising the back of the vehicle, be sure the vehicle is on level ground and the front wheels are blocked securely.

CAUTION: Do not use floor jacks to support the vehicle while working under it. Do not raise the vehicle onto concrete blocks, masonry or any other item not intended specifically for this use.

7. During installation, keep the work area clean. Do not allow anything to be dropped into intake, exhaust, or lubrication system components while performing the installation, as foreign objects will cause immediate engine damage upon start-up.

8. Save this Owner's Manual as a reference for system maintenance and service.

9. Banks recommends either a Banks iQ or a Pyrometer (EGT) gauge and Boost gauge be installed with the Six-Gun Diesel Tuner to help monitor performance and exhaust gas temperature of the vehicle (see part numbers next page). To further increase engine life by lower EGT's, Banks also recommends installing a Monster Exhaust® system (see next page).

Banks iQ System 61142

Banks Monster® Exhaust System

Std. Cab Long Bed 48632
Ext./Crew Cab Short Bed. 48633
Ext./Crew Cab Long Bed 48634
Std. Cab Long Bed, w/o Cat 48628
Ext./Crew Short Bed w/o Cat 48629
Ext./Crew Long Bed w/o Cat 48630
Head pipe kit w/o cat 48631

Additional Equipment

Ram-Air Intake Sys. LLY 42135
Ram-Air Intake Sys. LB7 42132
Ram-Air® Filter 41518

Ram-Air® Service Kit 90094
Techni-Cooler Sys. ('01) LB7 25976
Techni-Cooler Sys. ('02-04) LB7 .. 25977
Techni-Cooler Sys. ('04-05) LLY .. 25978

Gauges Assembly

Boost and Pyro 64507
Thermocouple 63042
Leadwire LLY 63062
Leadwire LB7 63061
Banks BigHead® Actuator LB7 24396



Section 1

INSTALLATION OF WIRING HARNESS, CONNECTIONS AND SIX-GUN DIESEL TUNER

1. Disconnect the battery ground cables from each of the batteries. Secure the cables so that they do not come in contact with the battery posts during the installation.

2. From the engine compartment, locate the rubber grommet high on the driver's side of the vehicle firewall. The grommet is about 3" in diameter. Make a 1" x 1" cross-shaped incision in the grommet (see **Figure 2**).

3. From the engine compartment, feed the grey three-connector cable

through the incision made in the firewall grommet and into the cab. From inside the cab, remove the lower dash panel under the steering column to allow access to these three connectors.

4. Locate the two black wire harness locking connectors between the brake fluid reservoir and the air conditioning compressor. Lift the gray connector locks and disconnect the 38-pin connector pair and the 24-pin connector pair (see **Figure 3**).

Figure 1 Six-Gun and supplied wiring harness



Figure 2

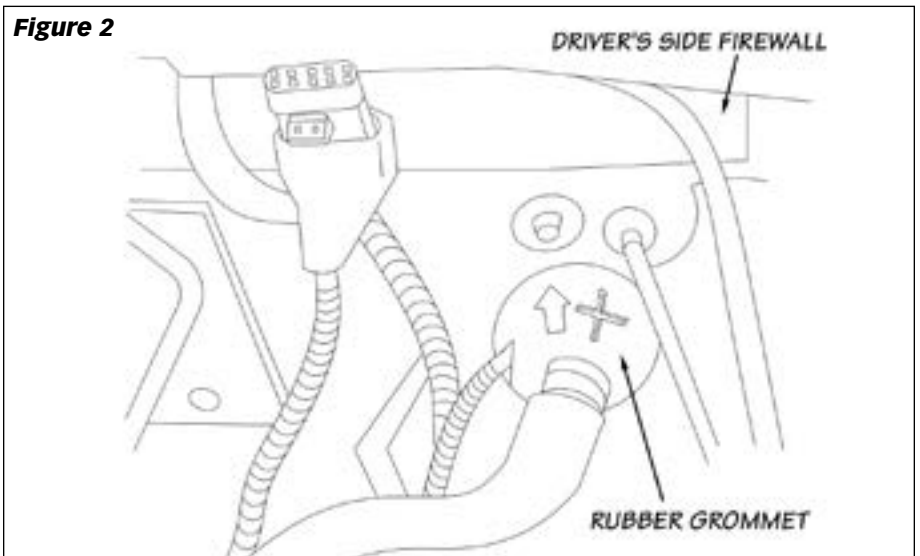

5. Insert the male 38-pin connector on the Six-Gun harness into the female 38-pin connector on the factory harness. Insert the female 38-pin connector on the Six-Gun harness onto the male 38-pin connector of the factory harness. Repeat this process with the 24-pin connectors (see **Figure 3**).

6. The Six-Gun is to be installed under the hood on the outside of the fuse box, with the wire harness facing towards the rear of the vehicle (see **Figure 4**). Make sure the outside of the fuse box is free of oil, grease and dirt.

7. With the Six-Gun Diesel Tuner positioned next to the fuse box, peel the protective backing from the hook and loop interlocking fasteners attached to the Six-Gun Diesel Tuner. Position the bottom edge of the Six-Gun Diesel Tuner approximately a half inch above the main wiring harness exiting the fuse box, then press the adhesive onto the outside of the fuse box. Apply light pressure to the Six-Gun Diesel Tuner by hand for

60- seconds to create a strong bond between the fuse box and hook & loop interlocking fasteners. Using the supplied cable ties, secure the wire harness away from any heat sources or moving components.

8. ALL 2001 thru (early) 2004 LB7 & (late) 2004 thru 2005 LLY(with Banks iQ ONLY) Vehicles:

Locate the Banks OBDII Interface Cable and the 11" cable tie in your kit. Connect the OBDII Interface Cable to the vehicle OBDII connector. Use the 11" cable tie as shown in **Figure 6** to secure the Banks interface cable to the vehicle OBDII connector. Now, connect the 6-pin connector from the Banks OBDII Interface Cable to the 6-pin connector on the Six-Gun Tuner incab cable.

NOTE: For LB7 only, if you are not installing the optional Banks iQ then coil up and secure the cable with the RJ12 (telephone style) connector end.

-END, SECTION 1-

Figure 3

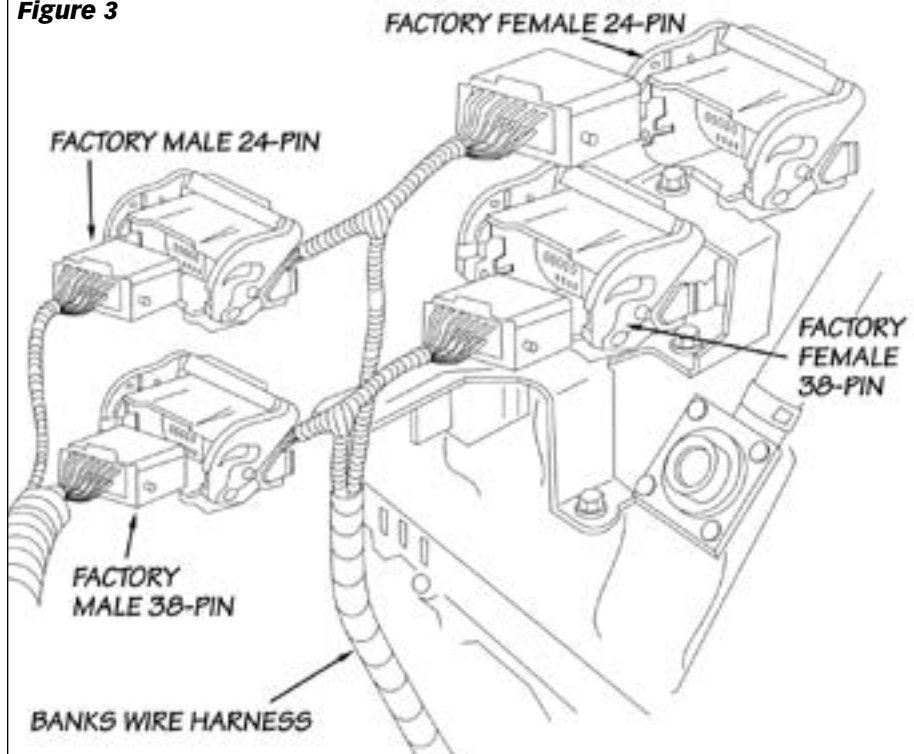

Figure 4 Six-Gun module mounted on fusebox



Section 2

MOUNTING THE DOCKING AND CONNECTING THE BANKS iQ

All 2001 thru (early) 2004 LB7 vehicles will have an OBD II Interface Cable in the kit. The OBD II Interface Cable must be connected in order for the Six-Gun tuner to function.

All (late) 2004 thru 2005 LLY vehicles will require an OBD II Interface Cable if connecting to an optional Banks iQ .

All Vehicles: If not installing the optional Banks iQ, skip to Section 3.

WARNING: Below 32°F (0°C) or above 140°F (60°C) the Banks iQ may be susceptible to damage as a result of extended direct exposure to sunlight, heat or extreme cold. It is highly recommended that the Banks iQ be removed from its mounting location if the vehicle will be subjected to high

concentrations of sunlight, heat or cold for an extended period of time. Gale Banks Engineering is not responsible for damage to Banks iQ resulting from exposure conditions.

CAUTION: Do not use force when working on plastic parts. Permanent damage to the part might result.

1. Locate the Window Mount Assembly in your kit.
2. Assemble the Banks iQ docking station to the Universal mount by inserting and sliding the Universal mount tab into the docking station groove. Hand tighten the nut behind the docking station to hold the docking station in place.

Figure 5 Attaching Banks iQ to window mount

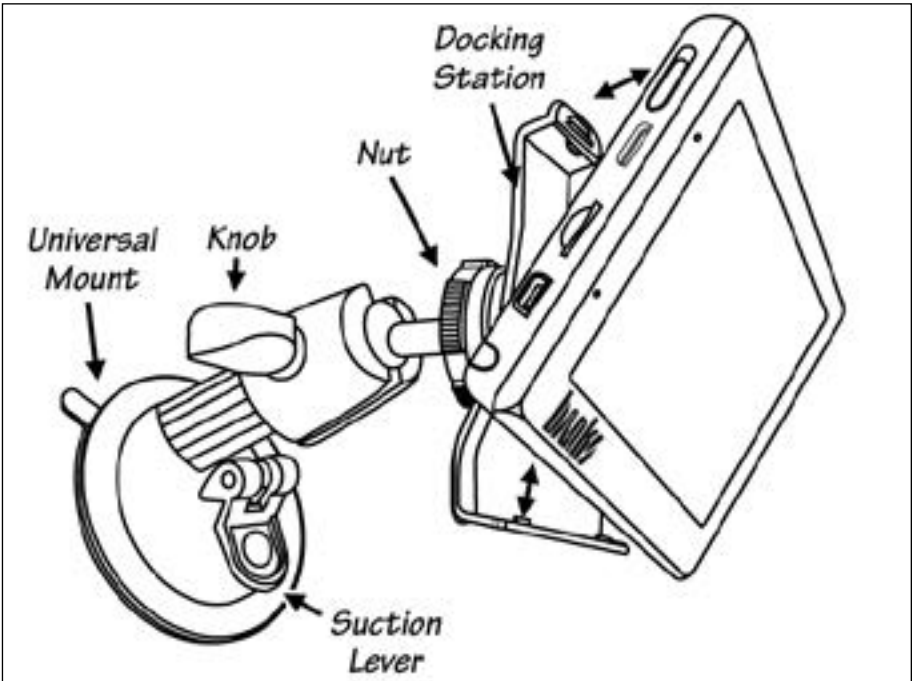

3. Attach the window mount to your Banks iQ. See **Figure 5**. Align and place the two (2) lower tabs on the window mount to the corresponding slots on the bottom of Banks iQ first then snap the top of Banks iQ into place.

NOTE: There may be a snug fit when installing the Banks iQ into the window mount. Take care not to force this process.

4. Find a suitable place on the windshield for ease of access and viewing of Banks iQ. Use location shown in **Figure 6** as a reference for mounting Banks iQ in your vehicle. Loosen the knob and move the swivel suction plate to achieve desired viewing angle of the Banks iQ screen. Do a test fit and note the angle necessary to achieve the correct viewing angle.

5. Make sure the suction cup and the mounting area on the windshield are clean and dry. With the suction lever in the up position, ensure the suction

cup is flat against the windshield, and then push the suction lever down to secure in place.

6. Next, remove and set the fuse access panel aside. See **Figure 6**.

7. *NOTE: This step completed in Section 1 step 8 by 2001 thru 2004 (early) LB7 truck owners.*

Locate the Banks OBD II Interface Cable in your kit. This cable has three connection points. Connect the RED OBD II connector on the Banks interface cable to the vehicle OBD II connector. Use a cable tie as shown in **Figure 7** to secure the Banks interface cable to the vehicle OBD II connector. Next, connect the 6-pin connector on the Banks OBD II interface cable to the 6-pin connector on the Six-Gun Tuner harness.

8. Locate the RJ12 Cable (similar to telephone connector) on your Banks OBDII interface cable. See **Figure 8**.

Figure 6 Mounting location for Banks iQ, Chevy LMM Shown



Figure 7



Figure 8 Banks iQ System

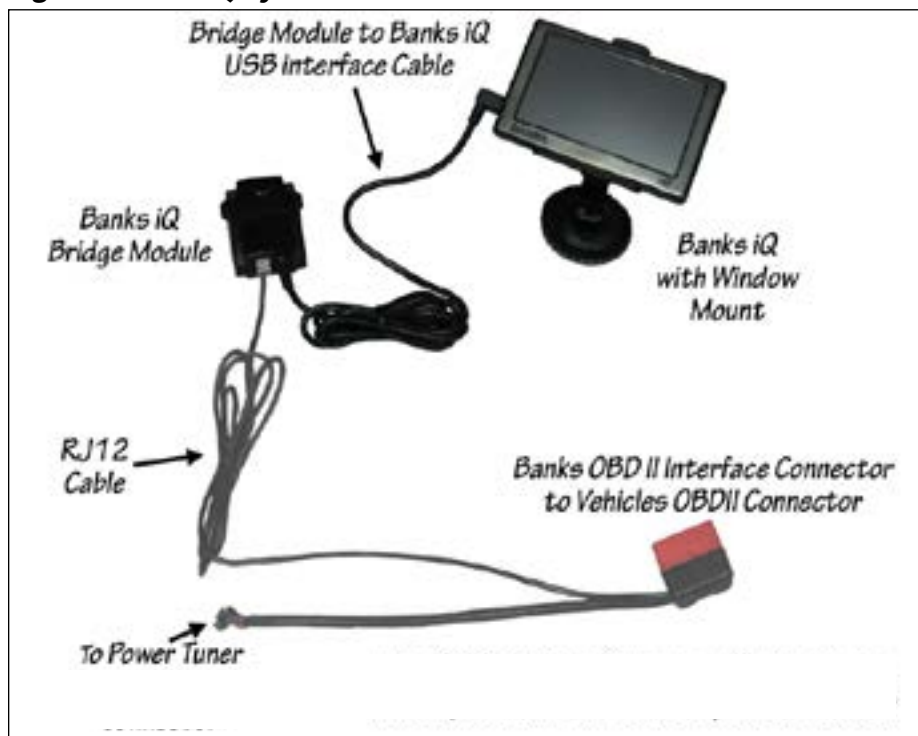

Figure 9 Banks Bridge Module



9. Locate Banks iQ Bridge Module and connect the RJ12 connector into the Bridge Module. See **Figure 9**.

10. Route the Banks iQ USB interface cable from the Banks iQ Bridge Module under the dash and out through the fuse access panel opening. The cable can be slid under the door frame's seal and run up to the top of the dash. Pull enough cable to reach the Banks iQ and connect it to the left receptacle on the iQ. See **Figure 6**. Snap the fuse access panel back in place making sure not to pinch the wire.

WARNING: THE CHARGING CABLE CONNECTED TO THE BANKS iQ IS DESIGNED TO SUPPLY A CONSTANT LOW-VOLTAGE POWER SOURCE (+5VDC) TO THE BANKS iQ AND IS "LIVE" AS LONG AS THE SYSTEM'S OBD II INTERFACE CABLE OR BANKS WIRING HARNESS IS COMPLETELY

INSTALLED AND THE USB CABLE CONNECTOR IS PLUGGED INTO BANKS iQ. ALTHOUGH THIS CHARGING CABLE IS SHORT AND ITS CIRCUITRY IS FUSE-PROTECTED, THE USER IS EXPECTED TO TAKE APPROPRIATE MEASURES TO PREVENT SMALL CHILDREN AND/OR PETS FROM CONTACT WITH ANY PART OF THIS SYSTEM.

11. Secure Banks iQ Bridge Module under the dash to any dash frame support using the supplied cable ties. Use the cable tie support loops on the side of the Bridge Module to securely fasten it under the dash.

12. Route all wiring away from any pedals or other moving components. Using the cable ties supplied, secure the wiring under the dash.

-END, SECTION 2-

Section 3

INSTALLATION OF THE SIX-GUN SELECTOR SWITCH

Not needed if optional Banks iQ is installed.

CAUTION: Do not use force when working on plastic parts. Permanent damage to the part might result.

1. The Six-Gun switch will be installed on the driver's side of the instrument panel (IP) next to the steering column (see **Figure 10**). Carefully remove the IP from the dashboard by slowly pulling outwards from the dashboard around the edges of the IP, allowing the mounting pins to pull free from their dashboard sockets. Automatic transmission equipped vehicles will need to set the parking brake and move the shift lever down to the lowest gear to allow clearance for instrument panel removal.

2. Cut out the supplied template (see **Figure 20** on page 27) and align the template onto the rear of the IP, squarely seating it on the top of the IP mounting pin (see **Figure 11**).

3. Using a $\frac{3}{8}$ " Uni-drill bit, center the bit onto the $\frac{3}{8}$ " drill location on the

template and slowly drill through the IP. Using a $\frac{1}{8}$ " drill bit, center and drill through the $\frac{1}{8}$ " location on the template. Remove and discard the template and any plastic shavings.

4. On the front side of the IP, align the Banks Six-Gun label onto the previously drilled hole (see **Figure 12**).

5. Remove the nut and internal tooth washer from the Six-Gun Switch. Rotate the shaft counter clockwise until the shaft stops. Verify the locating washer tab is inserted into the #6 position on the switch (see **Figure 13**).

NOTE: If the washer is in any position other than the #6, your Six-Gun Diesel Tuner will not select power levels properly.

6. After confirming the locating washer is in the #6 location, install the switch through the $\frac{3}{8}$ " hole on the backside of the instrument panel. The alignment pin should rest in the $\frac{1}{8}$ " hole and with the switch fully rotated counter clockwise; the shaft's flat side should be facing the steering column. Secure switch with internal tooth

Figure 10

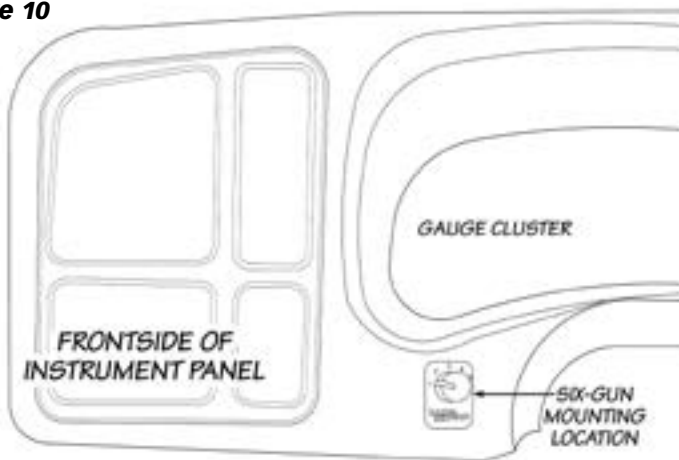

Figure 11

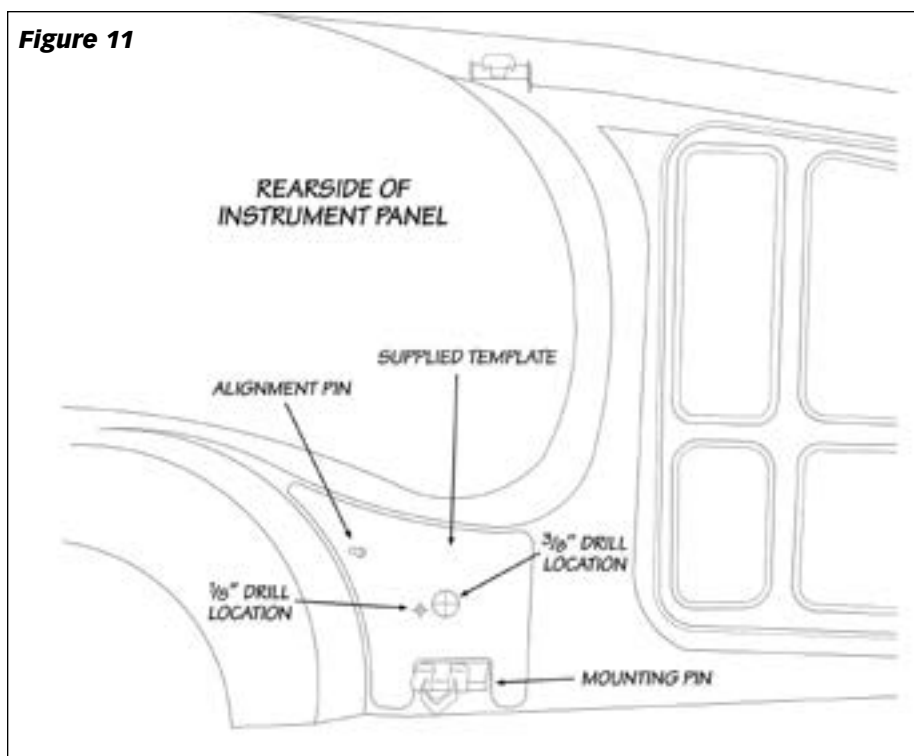

Figure 12

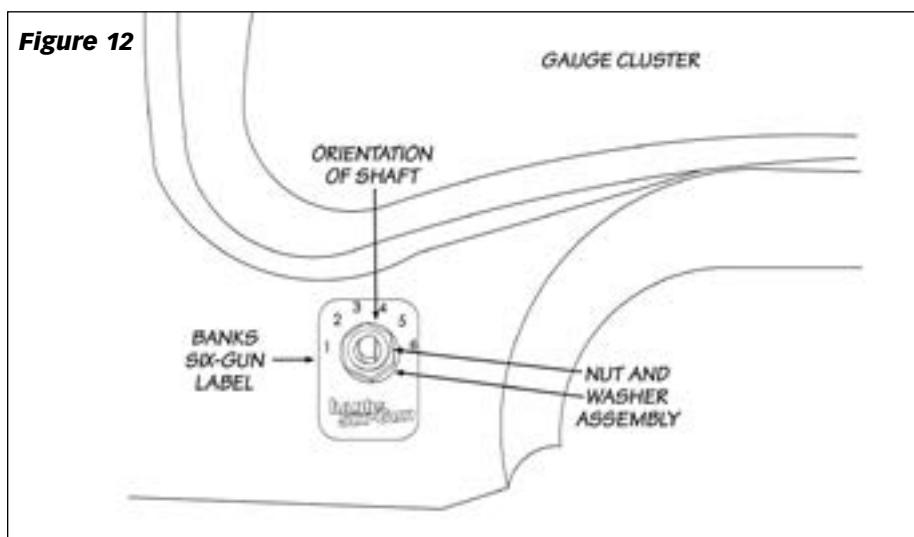
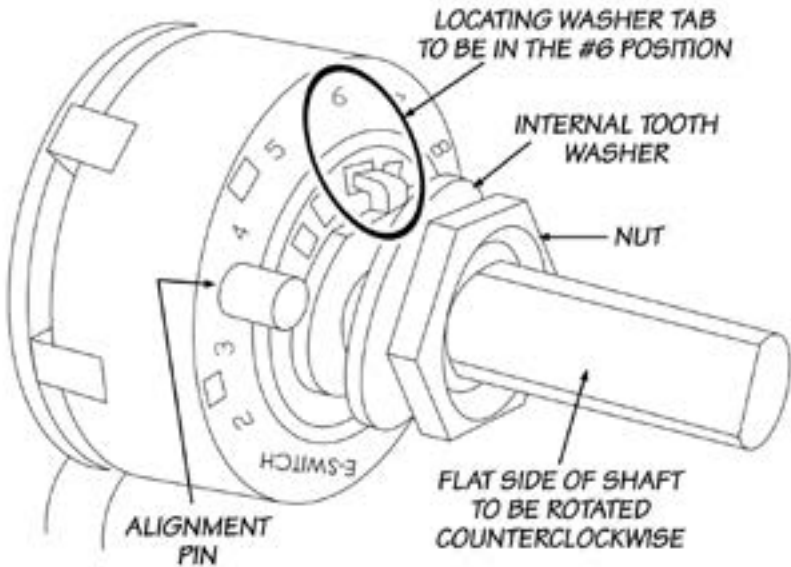

Figure 13



washer and nut. Snug the washer; be careful not to over torque the nut and damage the plastic threads.

7. Install the knob onto the shaft facing the #1 Level on the Six-Gun label. On the knob, snug the two (2) set screws with the supplied 0.050" hex key wrench.

8. Route the Six-Gun Switch cable down to the Six-Gun Diesel Tuner's three-connector cable underneath the dashboard, and reinstall the IP to the dashboard.

9. Connect the Six-Gun Switch Cable's 2-pin receptacle to the 2-pin plug on the Six-Gun Diesel Tuner's grey three-connector cable.

WARNING: if excessive torque converter slip is detected then a Limp Home Mode override will be set by the ECU. This LHM will be active until torque slippage is no longer detected or is reset by Diagnostic Tool.

-END, SECTION 3-

Section 4

OPTIONAL THERMOCOUPLE INSTALLATION (REQUIRED FOR OPTIONAL BANKS IQ)

- 1.** The thermocouple monitors the temperature of the exhaust gases entering the turbocharger at the turbine housing. Installation requires that the exhaust manifold be drilled near the manifold outlet. It is recommended that the manifold be removed from the engine to thoroughly clean out all metal chips from drilling. If manifold is not removed from the vehicle, all chips must be removed from the manifold. This may be accomplished by using a magnet to extract the chips after drilling. The tap should be greased before use and the chips again removed with a magnet. All metal shavings must be cleaned from the manifold to avoid turbine damage.
- 2.** To access the exhaust manifold, remove front passenger wheel well by removal of plastic retainers.
- 3.** On the passenger side, remove the hardware retaining the turbine inlet exhaust pipe to the exhaust manifold using a 12mm, 12pt socket along with a 12mm, 12pt wrench, then remove the exhaust manifold from vehicle. Pay special attention to the orientation of the manifold outlet gasket. Retain the hardware and gaskets for re-assembly.

- 4.** Center punch and drill through the passenger side exhaust manifold into the rear passage at the location shown (see **Figure 14**). Use a $\frac{7}{16}$ " drill, keeping the drill perpendicular to the manifold surface.
- 5.** Tap the drilled hole with a $\frac{1}{4}$ " NPT pipe tap. Check the thread depth as you tap by periodically removing the tap and screwing the thermo-couple insert into the tapped hole.
- 6.** Install the thermocouple insert into the manifold using anti-seize compound on the threads. Install the probe in the thermocouple insert.
- 7.** Make sure to remove all shavings from inside the exhaust manifold. Reinstall the exhaust manifold. Torque to 28 ft-lb in the sequence shown **Figure 14**.
- 8.** Attach the thermocouple to the supplied thermocouple leadwire extension with the supplied nuts and bolts. Cover this joint with the supplied heat shrink tubing and heat until the tubing conforms to the joint. Make sure the entire joint is insulated.
- 9.** Route the thermocouple leadwire extension along the factory harness to the driver's side and connect it to

Figure 14

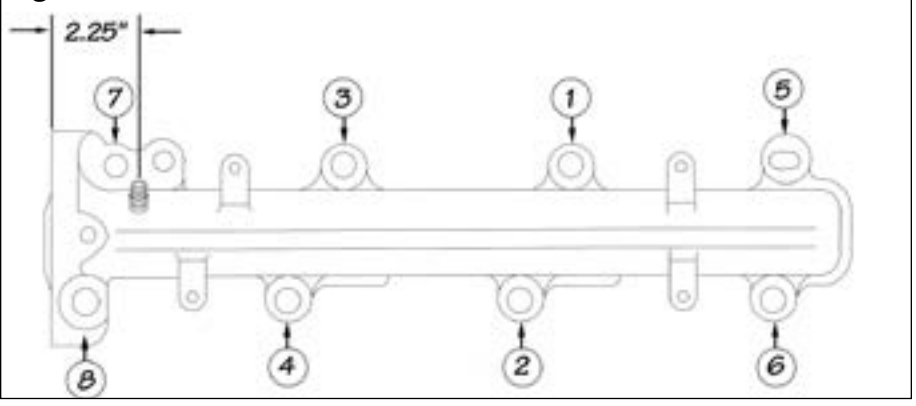

the Six-Gun harness with the supplied nuts and bolts. Cover this joint with the supplied heat shrink tubing and heat until the tubing conforms to the joint. **Make sure the entire joint is insulated.**

10. Reconnect the ground cables to the vehicles batteries.

NOTE: Once the Six-Gun Diesel Tuner is powered up at key-on, it will 'learn' that a thermocouple is installed and automatically enable the EGT limiting function. If the thermocouple is removed

*after being installed and run on the vehicle, the Six-Gun Diesel Tuner will assume that the sensor or connection has gone bad, and cease adding power while triggering the [2,3] diagnostic code (see Trouble Shooting **Section 8**). To ensure that the Six-Gun Diesel Tuner operates properly after removing a previously installed thermocouple, see the 'Clearing Learned Information' **Section 9. EGT limiting will not be operational and excessive EGTs may develop at higher power levels.***

-END, SECTION 4-

Section 5

AUTOMATIC TRANSMISSION LEARNING

NOTE: Please refer to the Banks iQ Software & Installation Kit, Owners Manual for software installation and operation instruction before beginning Section 6, Automatic Transmission Learning

The 6.6L Chevy Duramax Trucks equipped with the Allison 1000 5-speed automatic overdrive transmission use an adaptive shift control logic. This will require the transmission to adapt to the additional power created by the Banks Power products before it will shift properly. Failure to follow the sequence can result in damage to the transmission.

Perform the following sequence at a location where it is safe to accelerate without exceeding the posted speed limit.

- 1.** Set Six-Gun to level one power setting, start the truck and allow the engine to reach normal operating temperature.
- 2.** Adjust Six-Gun to level two, power setting.
- 3.** Drive vehicle for 5 to 10 miles ensuring a complete shift cycle through each gear. (The transmission shift adaptation learning process requires 15 to 30 complete shift cycles to learn new shift program.)

- 4.** Increase power level by one and repeat **Step 3** until the desired power level is achieved.

WARNING: Take particular care not to do wide open runs in 5th gear when in Automatic transmission Learning Mode, especially if speed loader is installed.

*The Allison 1000 5-speed automatic transmission will continually adapt to the power output of the engine to optimize shift quality. **The transmission will quickly adapt to the power setting if the driving cycle includes regular gear changes at high loads. The transmission learning procedure will need to be repeated when switching back to the higher power settings once the transmission adapts to the lower power settings.** It will be apparent when the transmission adapts to the lower settings by monitoring the feel of the gearshift. Gear changes will be noticeably harder when initially switching from a higher to lower power setting. This will soften as the transmission adapts to the new setting.*

-END, SECTION 5-

Section 6

CHECKING ENGINE PERFORMANCE

*The Six-Gun Diesel Tuner requires the engine coolant temperature (ECT) to be above 110° before it will add fuel. If the optional Banks iQ or DynaFact® gauges are installed, observe the operation of the boost and pyrometer (EGT) gauge values while driving under varying conditions. Turbocharger boost pressure will increase as a function of load and engine RPM, thus the engine will produce little boost while cruising at light throttle, with maximum boost while climbing hills heavily loaded during acceleration. Note the boost level seen during hard acceleration with a given load. If performance seems to have deteriorated sometime in the future, the maximum boost figures may be compared to see if boost has dropped off. Lower boost may be caused by turbo ducting leaks, a malfunctioning wastegate or fuel injection pump, or dirty air filter. Typical maximum boost pressure settings will vary considerably with stick or automatic transmission options, year model of vehicle and altitude. *Note: Before key-off, check tuner for error codes.**

Use your Banks iQ or EGT gauge to monitor exhaust gas temperature (EGT) in the engine. At idle, exhaust gas temperature will be very low, perhaps only 300°F. As the engine is accelerated for higher speeds with greater loads, the EGT will rise. The highest EGT will be seen under maximum load at full throttle, such as climbing a steep grade with a heavily laden vehicle.

To avoid heat damage to various engine components it is recommended that the exhaust gases cool below 400° before the engine is shut down. Your Six-Gun Diesel Tuner is calibrated to maintain a maximum EGT of 1350°F. You may experience brief excursions slightly above 1350°F under acceleration. This is normal and EGT should return to 1350°F or below within a few seconds. If you find that EGT remains high for any length of time, check for boost leaks or a dirty air filter.

-END, SECTION 6-

Section 7

TROUBLESHOOTING

Six-Gun Troubleshooting Using The Banks iQ

Check the Banks iQ's Status indicator for the "OK" icon on the upper left corner of the iQ screen. Any Tuner fault will be indicated by the "Banks Engine" icon (see **Figure 15**) and its cause can be investigated by running a 'Power Diagnostic' from the Diagnostic menu.



1. In the Environment select menu press on the 'Diagnostics' button. See **Figure 16**.
2. In the Diagnostics menu press on the 'Tuner Diagnostics' button to run a tuner diagnostics. See **Figure 17**.
3. The 'Self Diagnostic' screen displays a log of diagnostic events related to

the Power Tuner. The 'Logged Events' list takes a moment to update each time this screen is opened. Once the list is updated, the most current event will appear at the bottom of the list. Each event has an associated timestamp and description, which will be displayed below the list when that event is highlighted. Each key cycle of the vehicle produces a minimum of two logged events. See **Figure 18**. **Table 1** lists the common diagnostic codes and the suggested Course of Action for each.

4. Use the arrow buttons to scroll through the recorded events.
5. Touch the Banks iQ icon on the lower left of the screen to return to the environment screen or the return icon to return to the Diagnostics menu.
6. A pop-up "Log-File" screen will appear asking you if you want to erase the contents of the log. Press 'No' to keep the contents on Log-file or 'Yes', to erase the Log-files.

Figure 16



Figure 17



Figure 18



Six-Gun Troubleshooting (No Banks iQ Installed)

If you feel that your Six-Gun Diesel Tuner is not functioning properly, some diagnostics can be performed. Your Six-Gun Diesel Tuner is equipped with diagnostic features that will detect and display certain errors.

Remove the Six-Gun Diesel Tuner from its mounting location while keeping all connectors plugged in, and position

it in such a way that you can view the end of the Six-Gun housing that contains the LEDs from the driver's seat. Turn the vehicle key to the ON position. Observe the two LEDs mounted on the end of the Six-Gun Diesel Tuner:

- A steady GREEN LED will illuminate if all wire connections are correct, the engine is running, and the engine coolant temperature is within its normal operating range.

Table 1 Banks Six-Gun Diagnostic Codes

Code	Event	Course of Action
1,1	Fuel Rail Pressure (FPR) Input Voltage Out of Range	Turn ignition OFF and check the 24-Pin and 38-Pin connectors. Turn ignition back ON and re-check for presence of code.
1,2	Manifold Absolute Pressure (MAP) Input Voltage Out of Range.	Turn ignition OFF and check the 24-Pin and 38-Pin connectors. Turn ignition back ON and re-check for presence of code.
1,3	Six-Gun Switch Input Value Out of Range	Turn ignition OFF and make sure either Banks iQ or Six-Gun switch is connected to Six-Gun tuner. If Six-Gun switch is connected (no Banks iQ), check 2-pin connection on tuner's in-cab cable. Turn ignition back ON and re-check for presence of code.
1,4	(LB7) Barometric Pressure Input Voltage Out of Range (LLY) Barometric Pressure CAN Signal Not Available	Turn ignition OFF and check the 24-Pin and 38-Pin connectors. Turn ignition back ON and re-check for presence of code.
2,1	Fuel Rail Pressure (FPR) Output voltage Out of Range.	Turn ignition OFF and check the 24-Pin and 38-Pin connectors. Turn ignition back ON and re-check for presence of code.
2,2	Manifold Absolute Pressure (MAP) Output Voltage Out of Range.	Turn ignition OFF and check the 24-Pin and 38-Pin connectors. Turn ignition back ON and re-check for presence of code.
2,3	Exhaust Gas Temperature (EGT) Sensor Open Circuit.	Turn ignition OFF and check both thermocouple ring-terminal connections. Turn ignition back ON and re-check for presence of code.
2,4	(LB7) OBD Signal Malfunction	Turn ignition OFF and check OBD connector and cable. Turn ignition back ON and re-check for presence of code.
3,1	Crankshaft Position (CKP) Strand Fault or Internal Module Malfunction.	Turn ignition OFF and check the 24-Pin and 38-Pin connectors. Turn ignition back ON and re-check for presence of code.
3,2	Power Up Error or Internal Module Malfunction	Turn ignition OFF and check the 24-Pin and 38 Pin connectors. Turn ignition back ON and re-check for presence of code.
3,3	Low Battery Voltage or Internal Module Malfunction.	Turn ignition OFF and check the 24-Pin and 38-Pin connectors. Turn ignition back ON and re-check for presence of code.
3,4	CAN Communications Error with Vehicle.	Turn ignition OFF and check the 24-Pin and 38-Pin connectors. Turn ignition back ON and re-check for presence of code.
4,1	Injection Control Signal Fault or Internal Module Malfunction	Turn ignition OFF and check the 24-Pin and 38-Pin connectors. Turn ignition back ON and re-check for presence of code.
4,2	Transmission slippage Detected	Transmission is slipping excessively. Code will automatically clear once transmission stops slipping (repaired).
5,1	Internal Module Malfunction	Turn ignition off. Turn ignition back ON and re-check for presence of code.

If problem persists, call Gale Banks Engineering Tech Support.

- *The GREEN LED will flash* if all wire connections are correct, the engine is running, but the engine coolant temperature is not within its normal operating range. The GREEN LED will stop flashing once the engine coolant temperature is within its normal operating range (not to be confused with Speed-Loader flash on power-up).

- *No LEDs will illuminate* if the fuse on the Six-Gun wiring harness is blown or the wiring harness is not properly connected. If the fuse and all connections are okay, contact Banks Technical Service.

- *The RED LED will flash* in a certain sequence if a connection is incorrect or if there is a problem with the system – this sequence will identify one or more diagnostic codes. A Six-Gun Diesel Tuner's diagnostic code is comprised of 2 digits. Each code is expressed in a sequence of 2 sets of the flashing red LED separated by a brief flashing of the green LED in between. Each set of a number of red LED flashes represents a digit. A longer flashing of the green LED separates the sequences. The LEDs will continue

to flash to display all the errors, and then repeat. **Table 1** lists the common diagnostic codes. For example, if a faulty thermocouple is detected (code "2,3") by the Six-Gun Diesel Tuner, the following red and green LED flashing sequence is observed when the key is on:

- (1) Two times flashing RED LED
- (2) One time quick flashing GREEN LED
- (3) Three times flashing RED LED
- (4) One time longer flashing GREEN LED

The above flashing sequence will repeat continuously. When the problem is corrected, the diagnostic code will be eliminated and replaced by a steady green light. If problem persists, contact Banks Technical Service.

NOTE: If multiple codes are set, they will be displayed in a series separated by the longer flashing green LED. When reading codes, make sure to watch the entire series until you see the first code repeat.

-END, SECTION 7-

Section 8

CLEARING LEARNED INFORMATION

If the Six-Gun Diesel Tuner has been moved to a different vehicle, or you are instructed to do so by Banks Technical Staff, it is possible to reset all of the parameters that the Six-Gun has 'learned' - presence of an EGT thermocouple or Speed-Loader, etc.

CAUTION: The following procedures can only be carried out with the engine OFF!

- 1.** Turn the vehicle key to ON but **DO NOT** start the engine.

- 2.** Fully depress the throttle pedal and then release it completely. Repeat 5 times. The GREEN LED will flash when this is completed successfully.

- 3.** Turn the key OFF. Wait 30 seconds, or until the GREEN LED goes off and stays off. Turn the key back to the ON position but **DO NOT** start the engine.

- 4.** Fully depress the throttle pedal and then release it completely. Repeat 5 times.

-END, SECTION 8-

Section 9

PLACEMENT OF THE BANKS POWER DECALS

Figure 19

TYPICAL LEFT FENDER PLACEMENT



DURAMAX DIESEL

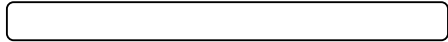

TYPICAL RIGHT FENDER PLACEMENT



DURAMAX DIESEL



Section 10

REMOVAL OF THE SIX-GUN DIESEL TUNER

If the Six-Gun Diesel Tuner should ever need to be removed from the vehicle, perform the following:

- 1.** Disconnect the Six-Gun's 38-pin connector from the factory harness.
- 2.** Re-connect the vehicle's 38-pin connector back into the factory harness.
- 3.** Disconnect the Six-Gun's 24-pin connector from the factory harness.
- 4.** Re-connect the vehicle's 24-pin connector back into the factory harness.

5. Disconnect the 2-ring terminals from the EGT thermocouple.

6. Disconnect the 3 small connectors on the 'In-Cab Cable' and gently pull the cable back through the firewall.

7. Remove the Six-Gun Diesel Tuner. Failure to follow the above instructions when removing the module will result in a "Check Engine" light on the dash and a Diagnostic Trouble Code being stored in the factory computer, in addition to the engine not running.

-END, SECTION 10-

Figure 20

