

banks

with Installation Instructions
Owner's Manual

**Banks Ram-Air®
Intake System**

**2017-2019 Chevrolet 6.6L Duramax
Turbo-Diesel Pickups**

THIS MANUAL IS FOR USE WITH KIT 42249,42249-D

banks

General Installation Practices

1. For ease of installation of your Banks Ram-air intake system, familiarize yourself with the procedure by reading the entire manual before starting work.
2. The exploded view of the Ram-Air assembly (pages 4-5) provides only general guidance. Refer to each step and section diagram in this manual for proper instruction.
3. Throughout this manual, the left side of the vehicle refers to the driver's side, and the right-side to the passenger's side.
4. Disconnect the ground cable from the battery before beginning work. If there are two batteries, disconnect both.
5. Route and tie wires and hoses a minimum of 6 inches away from exhaust heat, moving parts and sharp edges. Clearance of 8 inches or more is recommended where possible.
6. During installation, keep the work area clean. If foreign debris is transferred to any Banks system component, clean it thoroughly before installing.
7. When raising the vehicle, support it on properly weight-rated safety stands, ramps or a commercial hoist. Follow the manufacturer's safety precautions. Take care to balance the vehicle to prevent it from slipping or falling. When using ramps, be sure the front wheels are centered squarely on the topsides; put the transmission in park; set the parking brake; and place blocks behind the rear wheels.

⚠ CAUTION: Do not use floor jacks to support the vehicle while working under it. Do not raise the vehicle onto concrete blocks, masonry or any other item not intended specifically for this use.

NOTICE: The Banks Oiled Ram-Air Filter comes pre-oiled and no oiling is necessary for initial installation. Service the filter as specified in the Ram-Air Filter Cleaning Instructions Section of this manual.

⚠ WARNING! Vehicles that come with a Vehicle Emissions Control Information (VECI) label affixed to the Original Equipment Manufacturer's (OEM) air intake system airbox must replace the VECI label when installing a Banks Ram-Air® Intake System. A missing VECI label will prevent the vehicle from passing a smog inspection. A replacement VECI label can be obtained from the dealership. Replacement VECI labels must be in a location that is readily visible, on a painted surface in the engine bay, and shall not be affixed to any equipment that is easily detached from the vehicle.

Tools Required:

- 1/4" or 3/8" drive ratchets with metric sockets
- Standard and Phillips head screwdrivers
- Clean shop towels or rags
- 8mm or 5/16" Nut Driver
- T20 Torx Screwdriver

Table of Contents

Section 1 **4**
General Assembly

Section 2 **6**
Stock intake removal

Section 3 **8**
Ram-Air Installation

Section 4
Air Filter Cleaning Instructions **10**

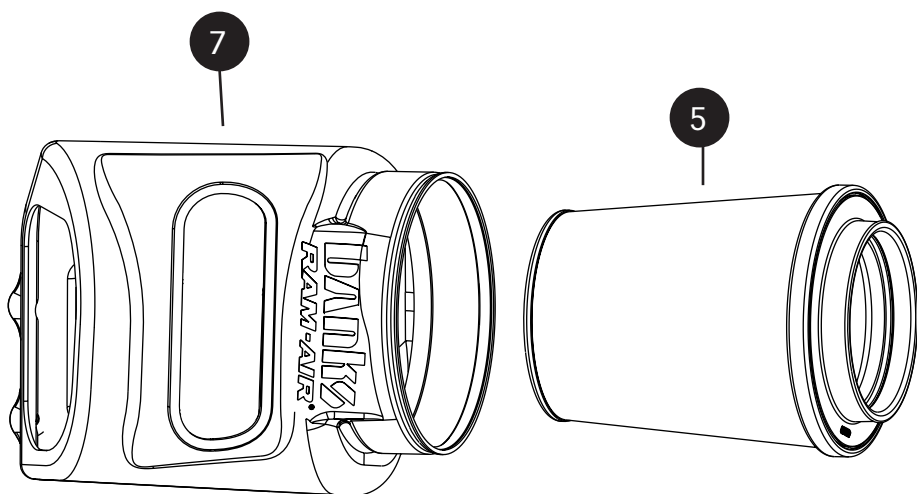

1	Intake Tube	42254	1
2	MAF Screws M4 x .7 8MM Long	91918	2
3	Intake Tube Elbow Hose	94007	1
4	Hose Clamp, #72 w/ Liner	92872	2
5	Air Filter	42259	1
6	Hose Clamp, #104	92904	1
7	Intake Housing	42257	1
8	Seal, Inner Fender (Long)	93143	1
9	Seal, Under Hood (Short)	93143	1

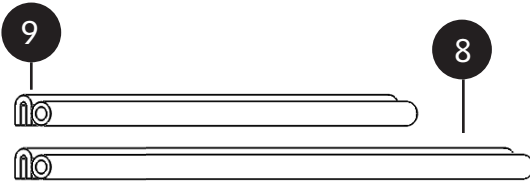
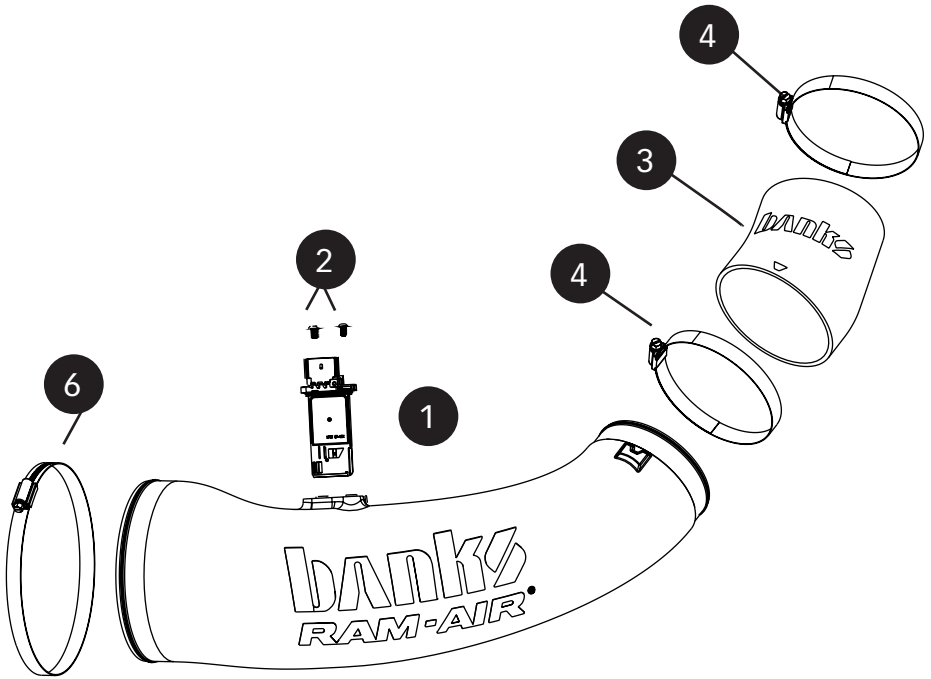

Section 2

STOCK INTAKE REMOVAL

You are about to install the Banks Ram-Air Intake System. Read and follow all steps before working on the vehicle. Some components from the stock air intake system will remain in service. Take care when removing stock air intake components to not damage them.

Use the Bill of Materials Chart and the General Assembly Drawing to reference component nomenclature and location. Use caution when working in the engine compartment. Make sure the engine has been OFF for several hours and cool.

1. Using an 8mm or 5/16" nut driver loosen the clamp holding the center intake tube to the air box. Next, loosen the clamp at the opposite end of the tube connecting it to the rubber boot. Remove the center intake tube and set aside. See **Figure 1**.

Figure 2

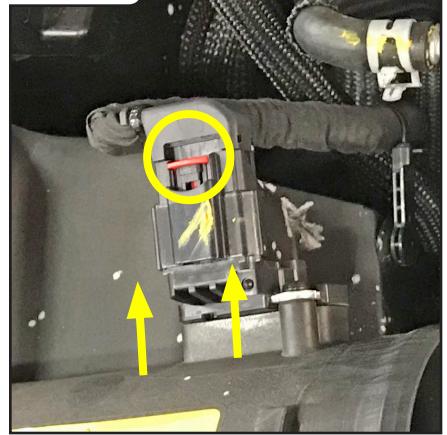
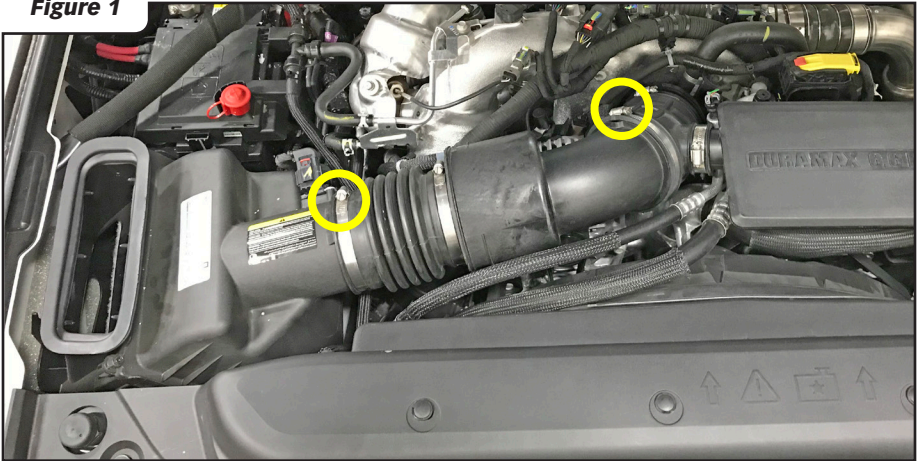

Figure 1



2. Slide the red locking mechanism up on the MAF (Mass Air Flow) sensor on the stock intake air box and disconnect it. See **Figure 2**.

NOTE: Be careful not to damage the connector or the MAF sensor during this process.

3. Disconnect the two factory ties on the air box just below where the MAF sensor was connected. The top tie secures the MAF wiring, while the other secures a coolant line. These ties will not be needed for the Banks air box. See **Figure 3**

Figure 3

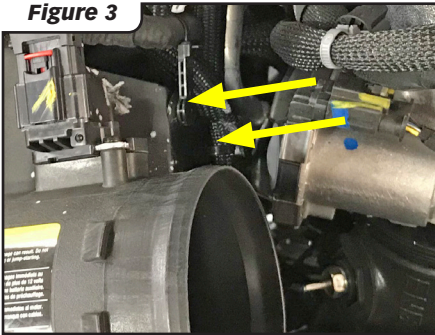

4. Remove the stock air box by lifting the air box up and out. The bottom of the stock air box is held in place by rubber grommets. There may be some resistance when removing the stock air box.

5. The stock air box tray needs to be removed. To do so, use a 10mm socket to remove the four bolts securing the tray then remove the tray. See **Figure 4**

Figure 4

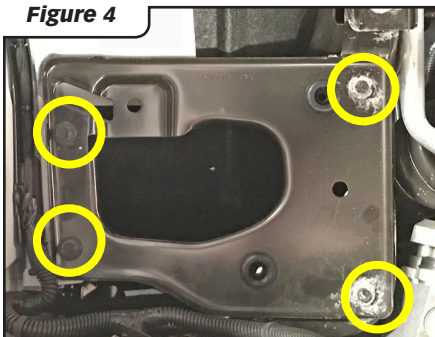

6. The Banks Ram-Air can be used with or without the stock intake resonator. The resonator will have "Duramax 6.6 HD" written on top of it and is connected to a rubber boot from which the intake tube was previously removed. If you wish to keep the silencer, disregard the next step. See **Figure 5**

NOTE: If you wish to retain the factory resonator, you will not be needing items 3 and both 4's shown on the assembly drawing on page 5 of this manual.

7. To remove the resonator, loosen the small clamp connecting the resonator to the rubber boot. Remove the nut located behind the resonator, which connects it to a bracket above the engine bay. Carefully pull up and out to remove the resonator. Loosen the last clamp on the rubber boot that connects the boot to the compressor inlet tube, and remove the rubber boot. See **Figure 6**

Figure 5



Figure 6

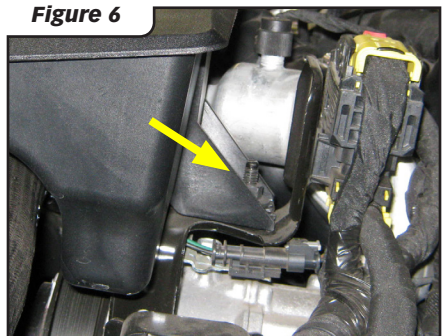

Section 3

RAM-AIR INSTALLATION

1. Disconnect the two screws securing the MAF sensor to the stock air box using a T20 Torx screwdriver, and remove the sensor. See **Figure 7**.

Figure 7

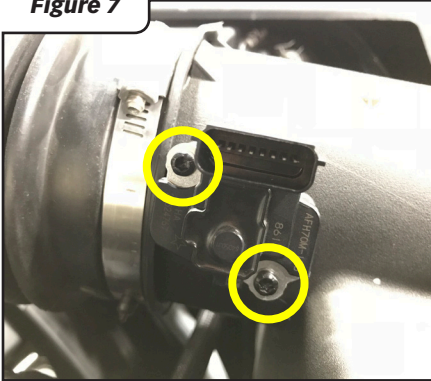

2. Install MAF sensor onto the Banks intake tube with new phillips screws supplied in kit.

CAUTION DO NOT OVER TIGHTEN SCREWS.

3. Prepare the Banks Intake Housing by installing the supplied seal pieces to the upper and side inlet openings. Trimming the trim pieces may be required for best finish. See **Figure 8**.

Figure 8



4. To install the Banks Intake Housing, secure the box with the outlet facing the center of the vehicle and bolt using the stock tray's previously removed bolts. See **Figure 9**.

Figure 9

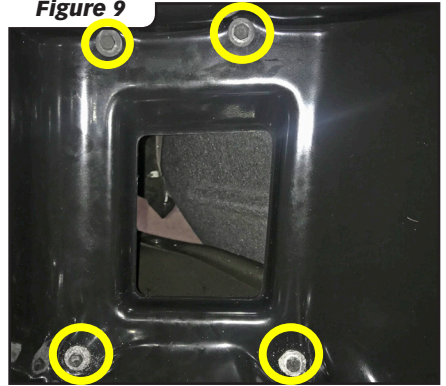

5. Locate the Banks Ram-Air filter and the Banks Intake tube, and connect the two parts using a supplied hose clamp.

6. If you are no longer using the factory resonator, connect the intake tube elbow hose to the intake tube with the arrow pointing to the mark on the intake tube. Using two supplied hose clamps. (92872) Leave the hose clamps loose. If you are no longer using the factory resonator, connect the intake tube elbow hose to the intake tube using two supplied hose clamps (92872). Orient the hose as shown in Figure 10 and leave the hose clamps loose.

Figure 10



CAUTION Skip this step if you are retaining the factory resonator.

7. The Banks intake housing has a slip-lock feature that allows the intake tube to move within the air-box once connected. To connect the fully assembled intake tube to the air box, simply push the filter end of the tube into the respective hole in the air box.

8. Attach the opposite end of the tube with the elbow coupler to the turbo compressor inlet, or directly to the resonator boot (without the elbow coupler) if you are retaining the factory resonator.

9. Tighten all the hose clamps to secure the intake tube. Position the intake tube for best fit and ensure intake tube is not touching any surrounding components.

10. Re-attach the sensor connector to the sensor in the Banks Ram-Air Intake tube. Slide the red mechanism to lock the sensor connector.

11. Your system contains a CARB EO label for emissions purposes. This label should be placed on the grill/radiator cross member inside the engine compartment, so that it is easily seen by an emissions technician.

12. Re-connect battery grounds. Make sure to check all hose clamps for tightness and connectors for a sure fit. Make sure that the intake tube is not touching any engine components. You have successfully completed the installation of the Banks Ram-Air Intake system.

Figure 11



Section 4

AIR FILTER CLEANING

NOTICE: The Banks Ram-Air Oiled Air Filter comes pre-oiled and no oiling is necessary for initial installation. Use Banks Ram-Air Filter Cleaning System (part#90094), available from Gale Banks Engineering to service the Air Filter. Follow the instructions included with the cleaning system to clean and re-oil your Bank Ram-Air Oiled Air Filter.

1. PRE-CLEANING

Tap the element to dislodge any large embedded dirt, then gently brush with a soft bristle brush.

NOTE: *If complete cleaning is not practical at this time, reoil the element and reinstall in your vehicle.*

2. SPRAY-ON CLEANING

Spray air-filter cleaner liberally onto the entire element and let soak for 10 minutes.

3. PAN CLEANING

Large air-filter elements can be rolled or soaked in a shallow pan of air-filter cleaner. Remove immediately and let soak for approximately 10 minutes.

NOTICE: NEVER use gasoline, steam, caustic solutions, strong detergents, high-pressure nozzles, or cleaning solvents to clean the filter element. All of these can cause harm to the filter media as well as SHRINK and HARDEN the rubber end caps.

4. RINSING

Rinse off the element with low-pressure water. Tap water is okay. Always flush from the clean side to dirty side. This removes the dirt and does not drive it into the filter.

5. DRYING

Always dry naturally. After rinsing, shake off all excess water and let the element dry naturally.

6. AEROSOL OILING

After cleaning air filter always reoil before using. Spray air filter oil down into each pleat with one pass per pleat. Wait 10 minutes and re-oil any white spots still showing.

7. OILING HINTS

Never use a Banks Ram-Air oiled filter without oil (the filter will not stop the dirt without the oil). Use only air filter oil. Air-filter oil is a compound of mineral and animal oil blended with special polymers to form a very efficient tack barrier. Red dye is added to show just where you have applied the oil. Eventually the red color will fade but the oil will remain and filter the air. NEVER USE Automatic Transmission Fluid. NEVER USE Motor Oil. NEVER USE Diesel Fuel. NEVER USE WD40, LPS, or other light-weight oils.

8. REINSTALL

Reinstall your Banks Ram-Air filter element with proper care. Make sure the element seats properly in the filter case. Install the cover making sure it's in the right position. Tighten all the nuts, bolts, screws or clips to factory specifications.

9. DO NOT DISCARD

Affix the "Do Not Discard" sticker to the filter case (included with every Banks replacement element). Make sure you put the sticker in a highly visible place to alert your mechanic not to discard.

10. PERFORMANCE HINTS

Service every 50-100,000 miles on street-driven applications. Service more often in offroad or heavy-dust conditions. If an air-filter restriction

restriction gauge is installed, then change the element when the air-filter restriction reaches 18"–H.O.

⚠️ CAUTION: **Extremely fine dust from agriculture or offroad use will pull the oil from the element. Frequent reoiling of the element's clean side might be required. Completely service when practicable. For extra protection use an air-filter sealing grease on rubber ends of the element. Service only with air-filter cleaner and air-filter oil.**

DRY FILTER CLEANING

Clean every 50-100,000 miles on street-driven applications. Clean more often in offroad or heavy-dust conditions. If an air-filter restriction gauge is installed, then change the element when the air-filter restriction reaches 18"–H.O.

1. PRE-CLEANING

Carefully tap the air filter element to dislodge any large embedded dirt or debris.

2. CLEANING

Spray an appropriate DRY AIR-FILTER CLEANER SOLUTION liberally onto both sides of the entire filter element with the majority applied to the dirty side. Soak for 10 minutes. Do not allow the DRY AIR-FILTER CLEANER SOLUTION to dry on the air filter.

⚠️ NOTICE: **NEVER use gasoline, steam, caustic solutions, strong detergents, high-pressure nozzles, or cleaning solvents to clean the filter element.** All of these can cause harm to the filter media as well as

SHRINK and HARDEN the rubber end caps.

3. RINSING

Rinse the filter element with cool or warm (not hot) water from the clean side out in order to flush the dirt out of the filter. It may be necessary to use your fingers on the hose to apply light water pressure. Repeat steps 2 and 3, until the water flowing through the media is completely clear of any dirt and debris.

5. DRYING

After rinsing, gently shake off excessive water and allow to dry naturally. Re-install the filter onto the intake system, airbox or custom assembly once it is dry or just slightly damp. Follow all original installation instructions.

6. REINSTALL

Reinstall your Banks Ram-Air filter element with proper care. Make sure the element seats properly in the filter case. Install the cover making sure it's in the right position. Tighten all the nuts, bolts, screws or clips to factory specifications.

7. DO NOT DISCARD

Affix the "Do Not Discard" sticker to the filter case (included with every Banks replacement element). Make sure you put the sticker in a highly visible place to alert your mechanic not to discard.

8. PERFORMANCE HINTS

Service every 50-100,000 miles on street-driven applications. Service more often in offroad or heavy-dust conditions. If an air-filter restriction gauge is installed, then change the element when the air-filter restriction reaches 18"–H.O.