

banks

with Installation Instructions
Owner's Manual

Banks Ram-Air® Intake System

**2001-2005 Chevrolet 6.6L Duramax
Turbo-Diesel Pickups**

THIS MANUAL IS FOR USE WITH KITS 42132, 42135, 42132-D, 42135-D

BANKS

General Installation Practices

Dear Customer,

If you have any questions concerning the installation of your Banks Ram-Air System, please call our Technical Service Hotline. If you have any questions relating to shipping or billing, please contact our Customer Service Department.

Thank you.

1. For ease of installation of your Banks Ram-air intake system, familiarize yourself with the procedure by reading the entire manual before starting work. This manual contains 24 pages of copy, illustrations and parts listing. If any pages are missing from this manual please call Gale Banks Engineering immediately for a replacement.

2. The exploded view of the Ram-Air assembly (pages 4-5) provides only general guidance. Refer to each step and section diagram in this manual for proper instruction.

3. Throughout this manual, the left side of the vehicle refers to the driver's side, and the right-side to the passenger's side.

4. Disconnect the ground cable from the battery before beginning work. If there are two batteries, disconnect both.

5. Route and tie wires and hoses a minimum of 6 inches away from exhaust heat, moving parts and sharp edges. Clearance of 8 inches or more is recommended where possible.

6. During installation, keep the work area clean. If foreign debris is transferred to any Banks system component, clean it thoroughly before installing.

7. When raising the vehicle, support it on properly weight-rated safety stands, ramps or a commercial hoist. Follow the manufacturer's safety precautions. Take care to balance the vehicle to prevent it from slipping or falling. When using ramps, be sure the front wheels are centered squarely on the topsides; put the transmission in park; set the parking brake; and place blocks behind the rear wheels.

⚠ CAUTION: Do not use floor jacks to support the vehicle while working under it. Do not raise the vehicle onto concrete blocks, masonry or any other item not intended specifically for this use.

NOTICE: The Banks Oiled Ram-Air Filter comes pre-oiled and no oiling is necessary for initial installation. Service the filter as specified in the Ram-Air Filter Cleaning Instructions Section of this manual.

Tools Required:

- 3/8" drive ratchets with metric sockets
- Standard and Phillips head screwdrivers
- Standard and needle-nose pliers
- Clean shop towels or rags
- 5/16 nut driver

Table of Contents

Section 1	4
General Assembly	
Section 2	6
Ram-Air Installation	
Section 3	
Oiled Air Filter Cleaning Instructions . . .	21
Dry Air Filter Cleaning Instructions . . .	23

Section 1

General Assembly

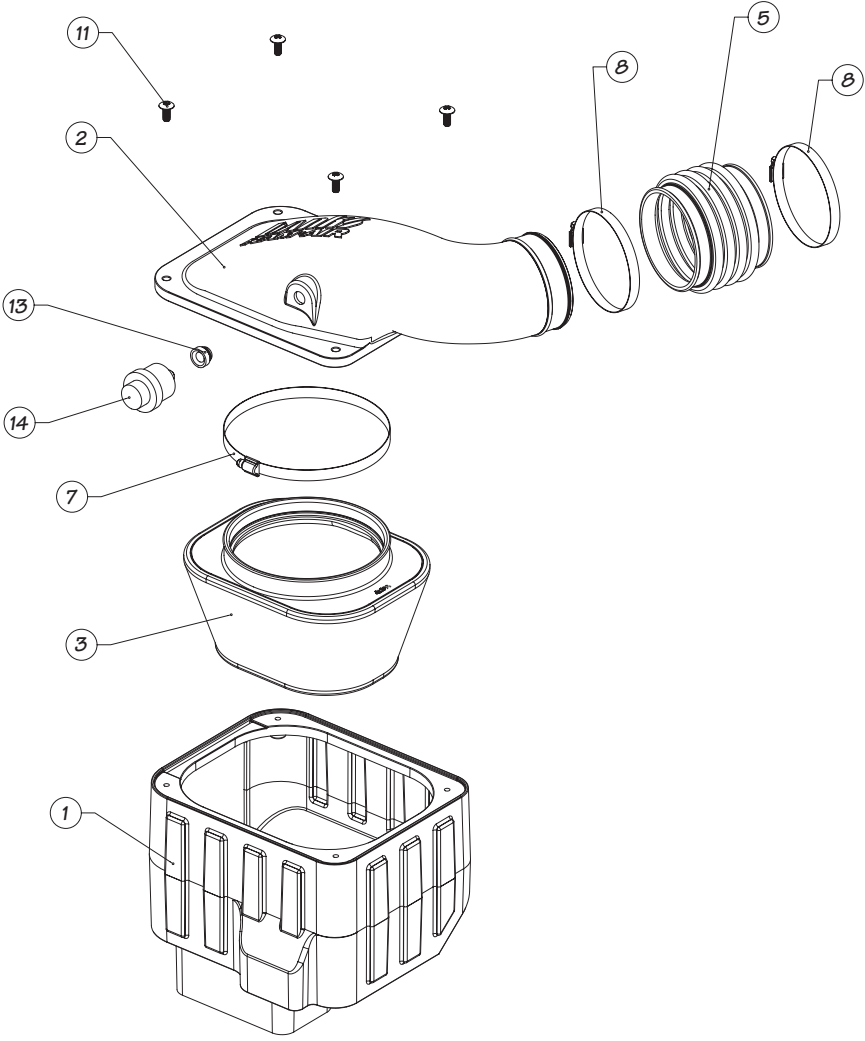

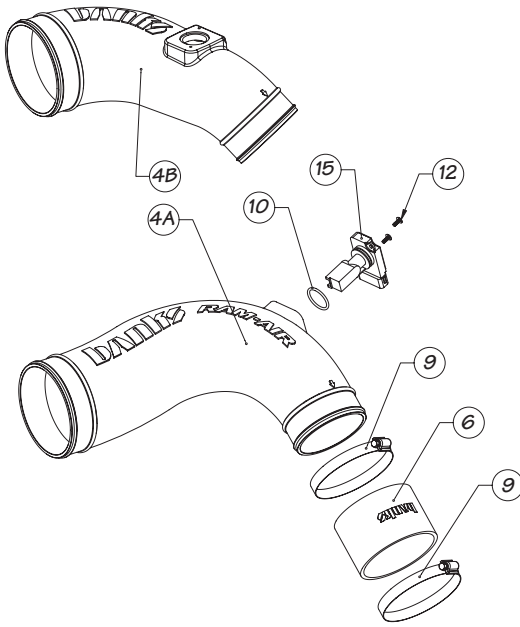

Item	Description	P/N	Qty
1	HOUSING, Ram-Air FILTER	42136	1
2	COVER, Ram-Air HOUSING	42137	1
3	AIR FILTER ELEMENT, Ram-Air SYSTEM	42138/42138-D	1
4A	INTAKE TUBE, Ram-Air SYSTEM FOR LLY (2004-2005)	42139	1
4B	INTAKE TUBE, Ram-Air SYSTEM FOR LB7 (2001-2004)	42140	1
5	HOSE, BELLOWS, 4.50 I.D.	94300	1
6	HOSE, COMPRESSOR INLET	94298	1
7	HOSE CLAMP, #128	92928	1
8	HOSE CLAMP, #72 w/LINER	92872	2
9	HOSE CLAMP, #56 w/LINER	92857	2
10	O-RING, 50A DUROMETER BUNA, -121 size	93740	1
11	SCREW, TRUSS HEAD, PHILLIPS, 5/16-18 X 3/4	91226	4
12	SCREW, TRUSS HEAD, PHILLIPS, 6-32 X 3/8	91718	2
13	STOCK GROMMET, FILTER MINDER	*	
14	STOCK FILTER MINDER	*	
15	STOCK MAF SENSOR	*	

* These are stock components that will be re-used with the Banks Ram-Air System.

Section 2

RAM-AIR INSTALLATION

Use the Bill of Materials Chart and the General Assembly Drawing to reference component nomenclature and location. Use caution when working in the engine compartment. Make sure the engine has been OFF for several hours and cool.

You are about to install the Banks Ram-Air Intake System. Read and follow all steps before working on the vehicle. Some components from the stock air intake system will remain in service. Take care when removing stock air intake components to not damage them.

1. Loosen the hose clamp from the stock intake tube on the compressor inlet. See **Figure 1**.

Note: If you have a 2001 thru 2004 LB7 Duramax engine then you will have either a decorative cover or a resonator covering the intake manifold. The decorative cover may

*need to be removed in order to facilitate installation and alignment of the Banks Ram-air intake system. Remove the decorative cover by removing the screw securing the rubber grommet. Once the rubber grommet is removed, lift up and unhinge the decorative cover from its mount. Reinstall decorative cover after the installation of the Banks Ram-air system is complete. See **Figure 2***

If you have the resonator with attached decorative cover then the resonator and attached decorative cover will be removed from the engine and will not be used in conjunction with the Banks Ram-Air intake system. See **Figure 3**.

2. Loosen and separate the stock hose clamp on the inlet tube connected to the stock air box cover. See **Figure 4**.

Figure 1

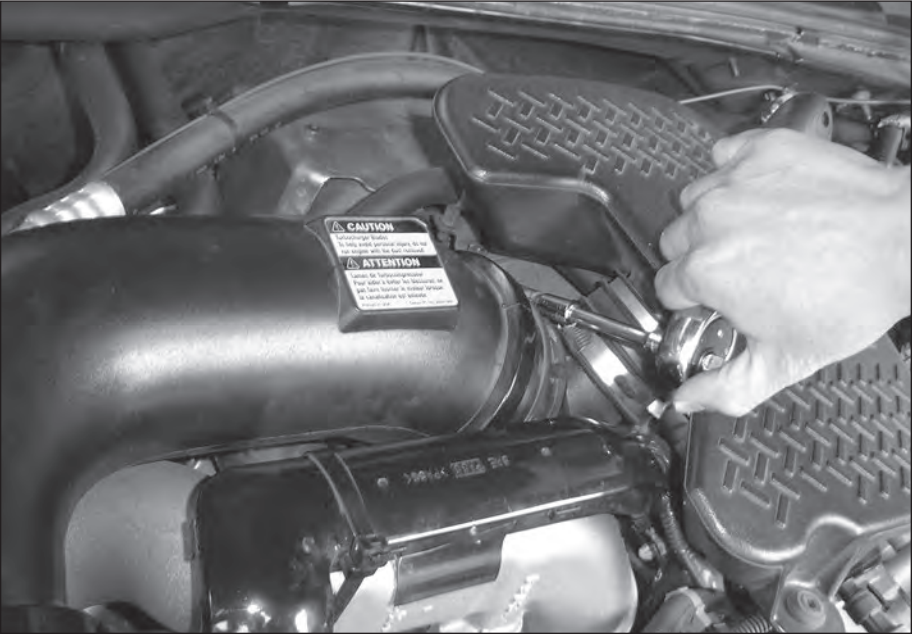

Figure 2

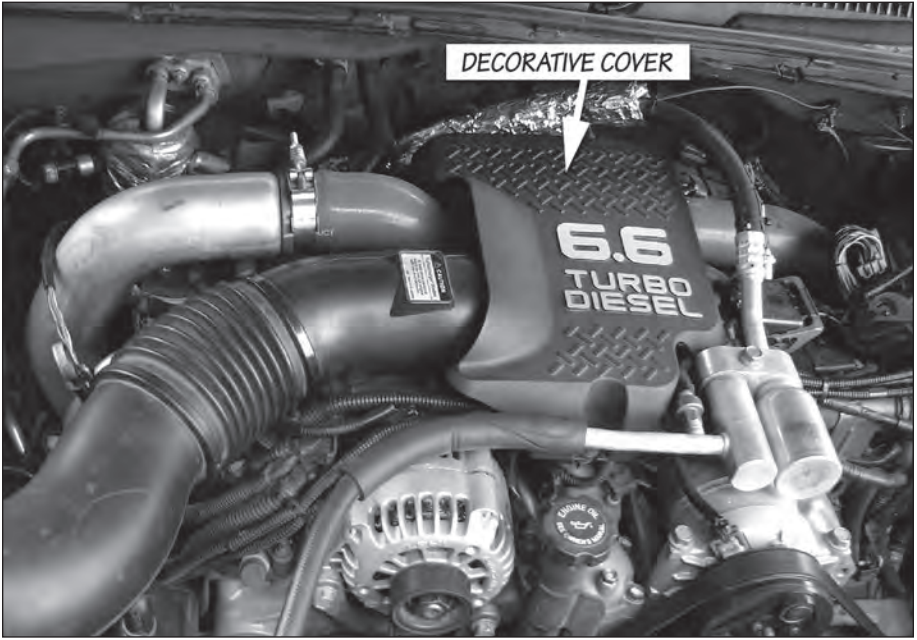

Figure 3

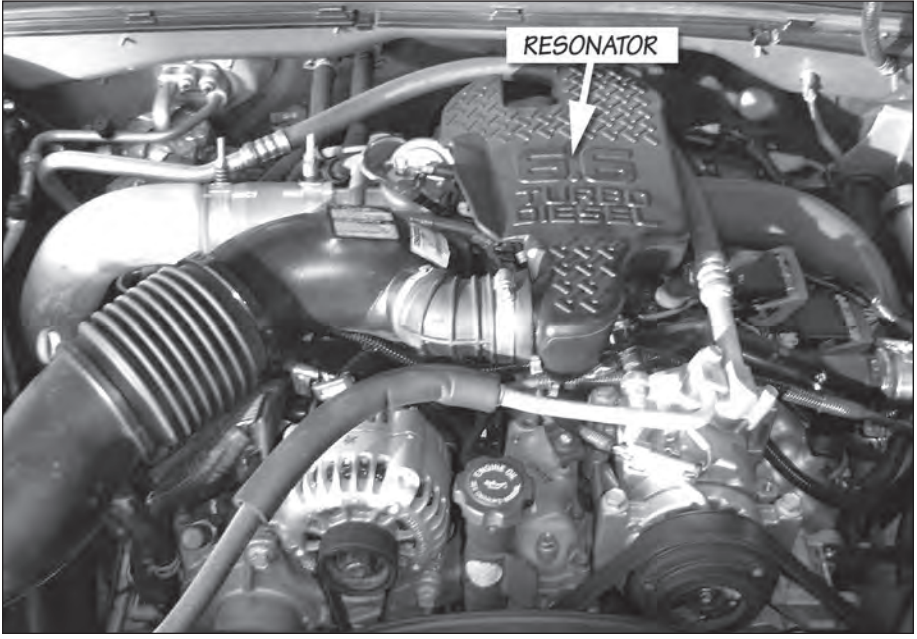
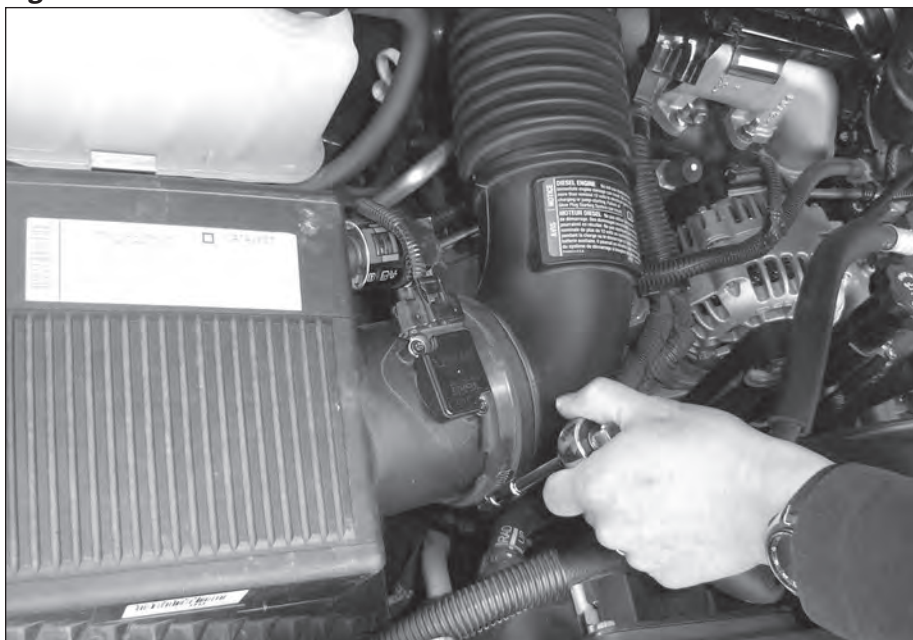

Figure 4



3. Separate stock intake tube from compressor inlet and remove the stock intake tube from the engine.

4. Remove Mass Air Flow (MAF) sensor connector from stock air box filter cover. *Note: Be careful not to damage the connector or the MAF sensor during this process.* See **Figure 5**.

5. Remove stock air box by lifting the air box up and out. The bottom of the stock air box is held in place by rubber grommets. There may be some slight resistance when removing the stock air box.

6. Next, remove the stock air box tray. Remove the bolts accessible from the top of the engine compartment as shown then remove the stock air box tray. See **Figure 6**. Keep the previously removed bolts for reassembly later in the installation process.

7. Locate your Banks Ram-Air filter housing from your kit and install as shown. Install housing and align Banks Ram-Air filter housing holes with bolt holes in engine compartment. Install the previously removed stock air box bolts to secure the Banks Ram-Air filter housing. Do not tighten the bolts at this time. *Note: The cutout on Banks Ram-Air filter housing must face passenger side fender.* See **Figure 7**.

8. Locate your Banks Torx tool, T20H in your Banks Ram-Air kit. Use the Torx tool bit to remove the two (2) screws securing the MAF sensor to the stock air box cover. See **Figure 8**. *Note: careful when removing the MAF Sensor. When removing the MAF sensor, grasp its body and pull up and out. Do not twist or bend when removing.*

Figure 5

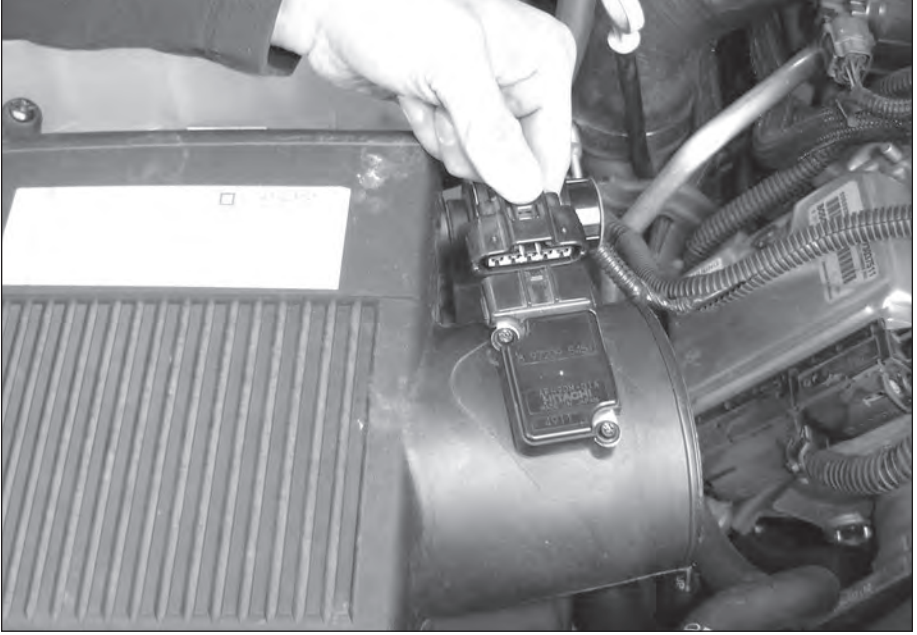

Figure 6

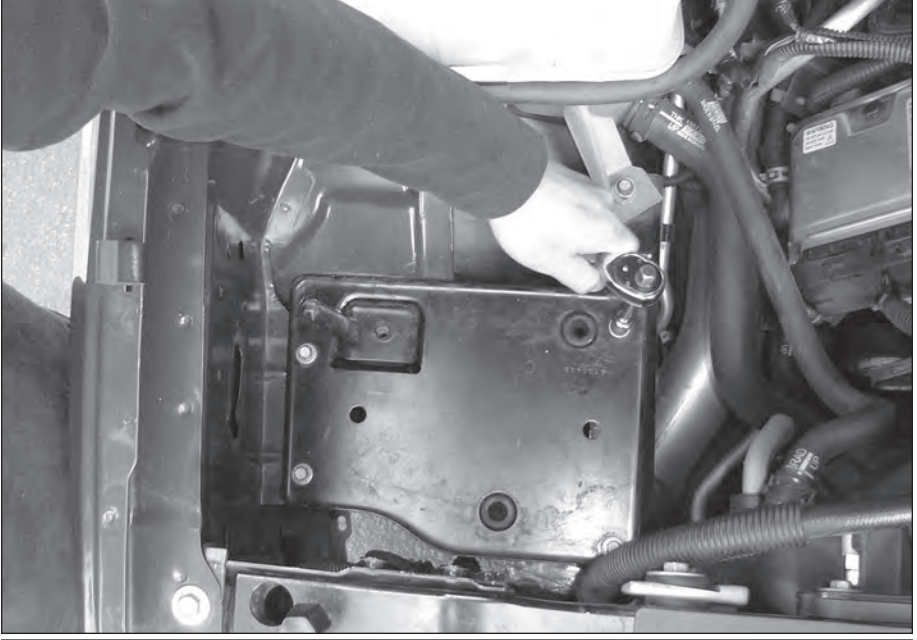

Figure 7

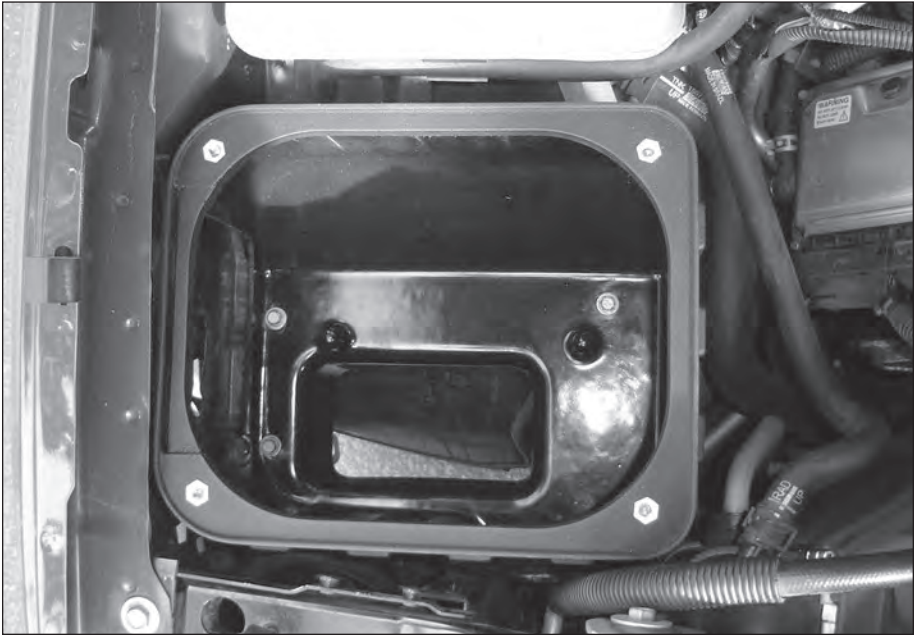
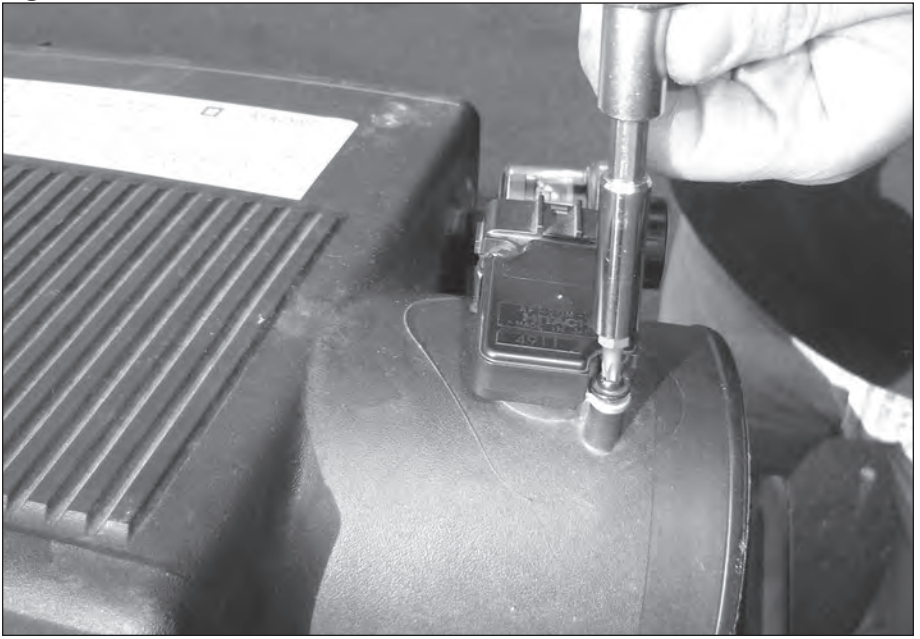

Figure 8



9. Locate the Banks MAF sensor o-ring supplied in your kit. Install Banks o-ring as shown. Ensure o-ring is flush to MAF sensor edge as shown *Note: Retain stock o-ring. Keep stock o-ring in place, you will be installing the Banks o-ring while retaining the original o-ring on the MAF sensor.* See **Figure 9**.

10. Locate your Banks Ram-Air intake tube in your kit. Install the stock MAF sensor (with the additional Banks o-ring) to MAF sensor mounting boss as shown. Tighten screws to 3 in/lbs.

Note: Ensure correct alignment as shown otherwise screw holes will not align with screw holes in the Banks Ram-Air intake tube. See **Figure 10**.

Caution: DO NOT OVER TIGHTEN SCREWS

11. Locate the Banks compressor inlet hose and hose clamps from your

Banks Ram kit. Loosely fit the hose clamp onto your Banks inlet hose. Install the Banks inlet hose and hose clamp and tighten it to the compressor inlet. See **Figure 11**.

12. Install Banks Ram-Air intake tube to Banks inlet hose and hose clamp. *Lightly tighten the hose clamp. Note: leave the clamps snug to allow movement of the inlet hose to allow correct alignment.* See **Figure 12**.

13. Locate the previously removed stock air box and remove the stock air filter Minder. Make sure to remove the stock air filter Minder rubber grommet as well. See **Figure 13**.

14. Locate the Banks Ram-Air filter housing cover. Install the previously removed air filter minder rubber grommet into the Banks Ram-Air filter housing cover. Once rubber grommet is installed flush into the Banks Ram-Air cover, then locate the previously

Figure 9

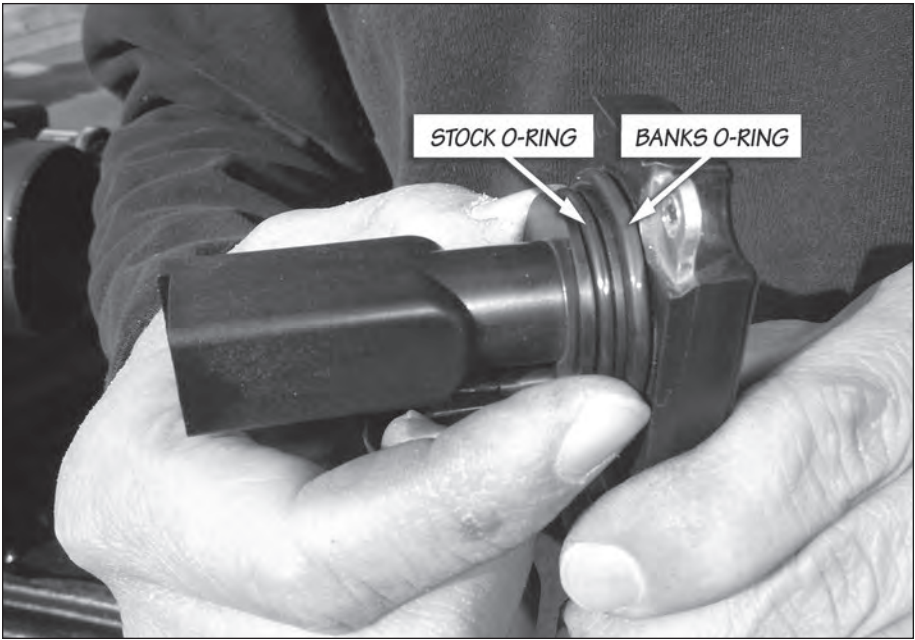

Figure 10



Figure 11



Figure 12

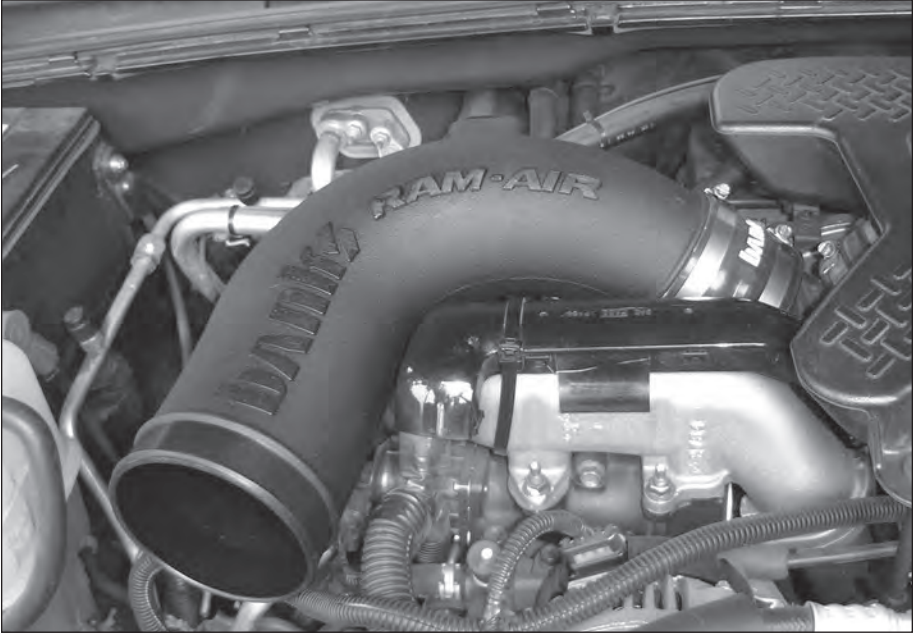

Figure 13



removed air filter minder and install into the rubber grommet. Make sure air filter minder is installed flush to rubber grommet. See **Figure 14**.

15. Locate the Banks Ram-Air filter and the Banks filter hose clamp. Loosely fit the Banks Ram-Air filter clamp to the Banks Ram-Air filter. See **Figure 15**.

*Note: See **Figure 16** to reference the correct alignment locator groove to the Banks Ram-Air filter.*

16. After verifying the correct alignment between the Banks Ram-Air filter and the Banks Ram-Air cover, snap fit the two pieces together until an audible snap is heard. This process will ensure that a correct seal has been established.

17. Tighten the Banks Ram-Air filter hose clamp to the Banks Ram-Air filter cover.

18. Place the Banks Ram-Air filter cover onto the Banks Ram-Air housing. See **Figure 17**. Locate the screws for the Banks Ram-Air housing cover in your kit. Align and loosely fit the Banks Ram-Air cover onto the Banks Ram-Air housing. *Note: Use the Banks Ram-Air cover and Banks Ram-Air housing to fine tune alignment between Banks Ram-Air intake tube and Banks Ram-Air filter cover. The Banks Intake Tube can be rotated to facilitate in alignment.* See **Figure 18** and **Figure 19**.

CAUTION: Ensure Intake tube is not touching any engine components, specifically the boost tube and intake manifold hose clamps.

19. Tighten the upper (top) hose clamp intake tube.

20. Remove the Banks Ram-Air housing cover screws and remove the Banks Ram-Air housing cover. *Note: Be*

Figure 14

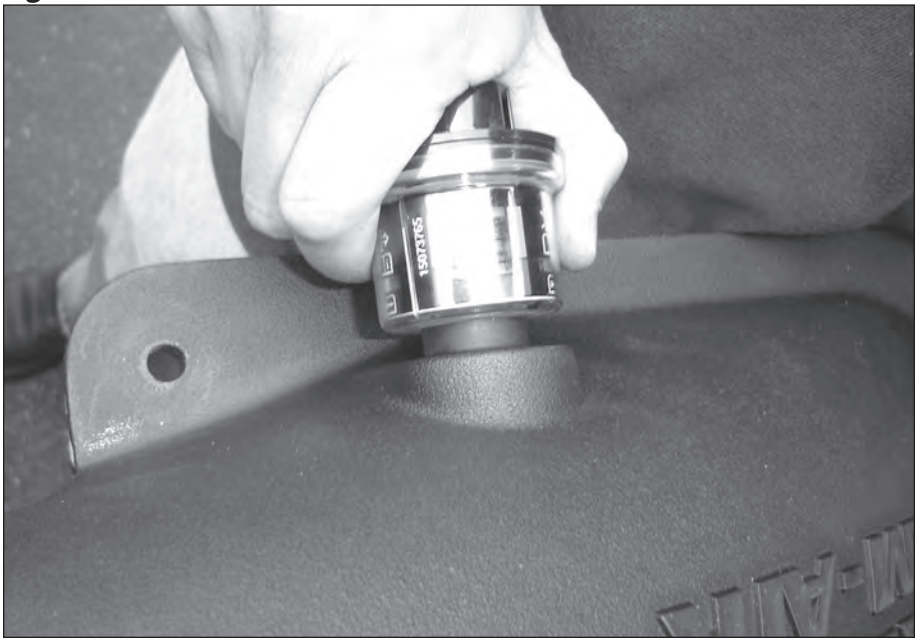

Figure 15



Figure 16

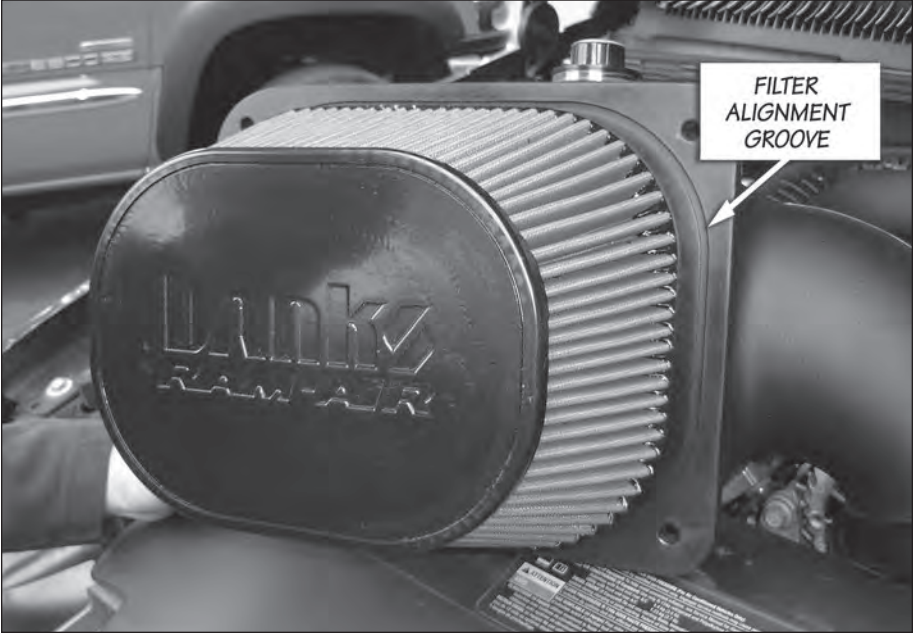

Figure 17

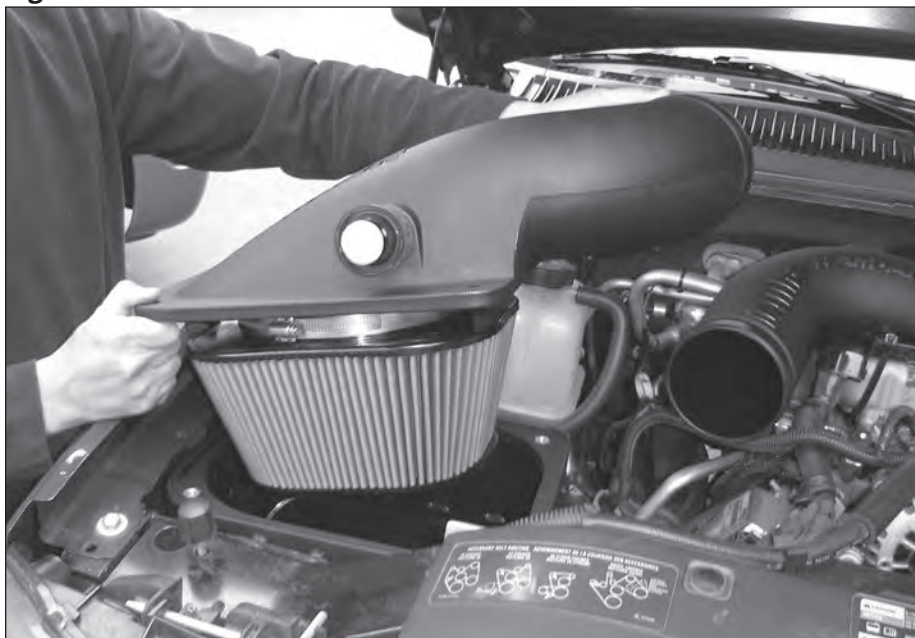

Figure 18

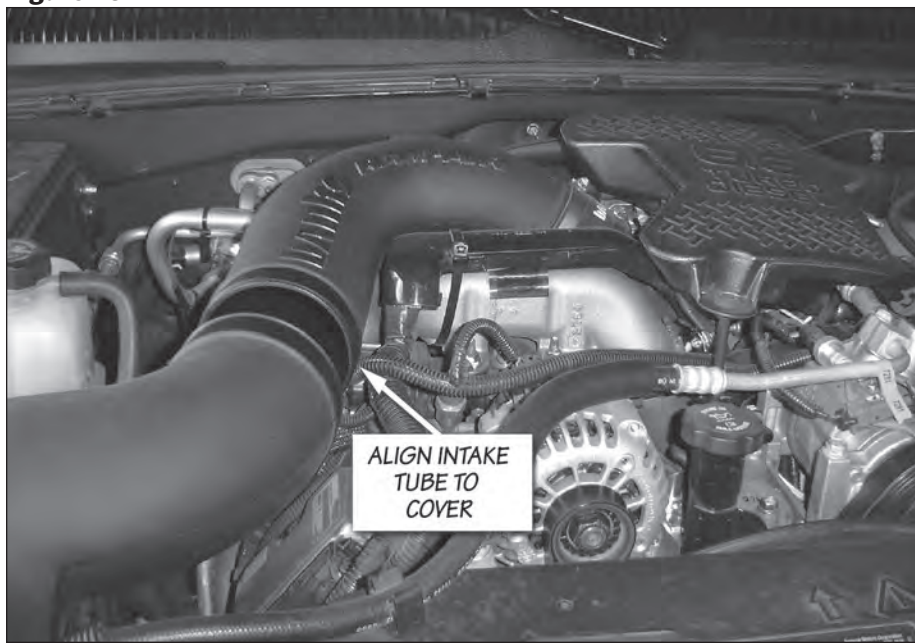
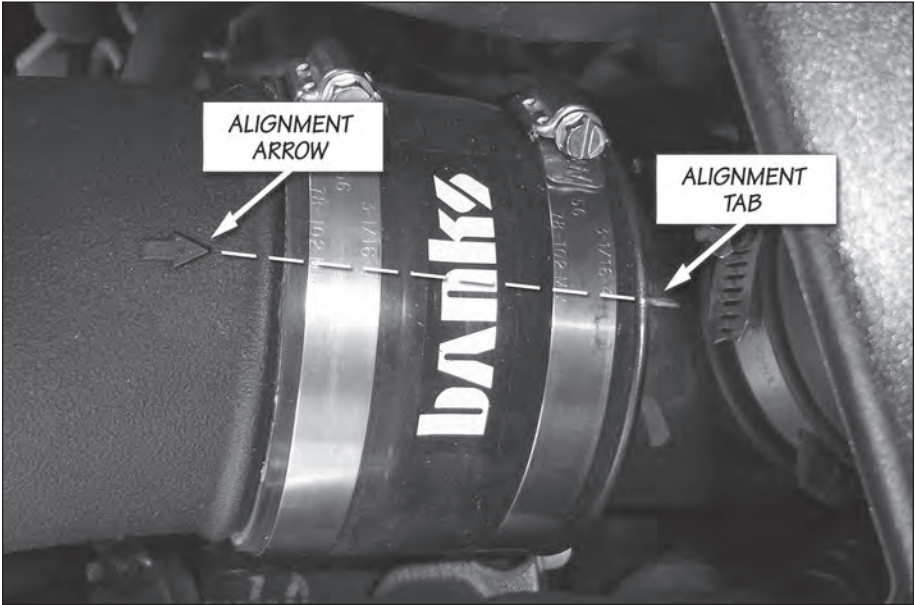

Figure 19



careful not to disturb the alignment.

21. Tighten the Banks Ram-Air filter housing bolts to vehicle frame. See **Figure 20**.

22. Install the Banks bellows hose and hose clamp onto the Banks Ram-Air intake tube. See **Figure 21**.

23. Loosely fit the hose clamp to the other end of the bellows.

24. Install the Banks Ram-Air cover into bellows.

25. Install Banks Ram-Air cover w/ filter after installing into bellows into the Banks Ram-Air filter housing. *Note: a slight resistance in pressing in the Banks bellows is normal.* See **Figure 22**.

26. Now with the Banks Ram-Air filter housing cover and Banks bellows fully seated flush, fasten the Banks cover to the Banks housing using the Banks cover screws and tighten.

27. Make sure that the Banks bellows is flush with the Banks cover connection bead and tighten the Banks bellows hose clamp. *Note: bellows will need to be compressed slightly.*

28. Connect MAF sensor connector to intake tube. *Note: you may have to loosen wire harness clips, to increase slack in length of wire harness available to connect to intake air tube* See **Figure 23**.

29. Re-connect battery grounds.

You have successfully completed the installation of the Banks Ram-Air Intake system. See **Figure 24**. Make sure to go over all hose clamps for tightness and connectors for a sure fit. Make sure that the intake tube is not touching any engine components, specifically the boost tube and intake manifold hose clamps.

-END, SECTION 2-

Figure 20



Figure 21

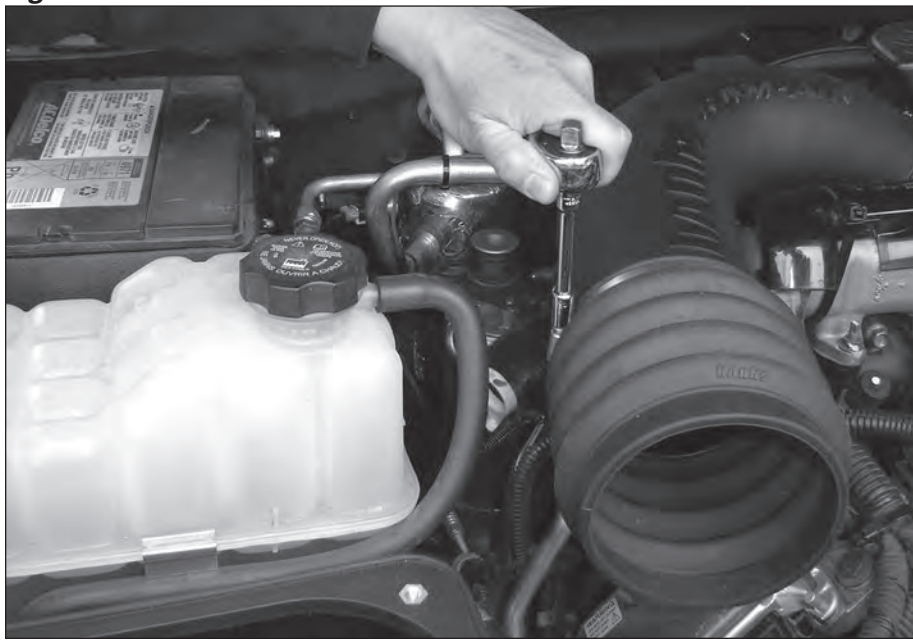

Figure 22

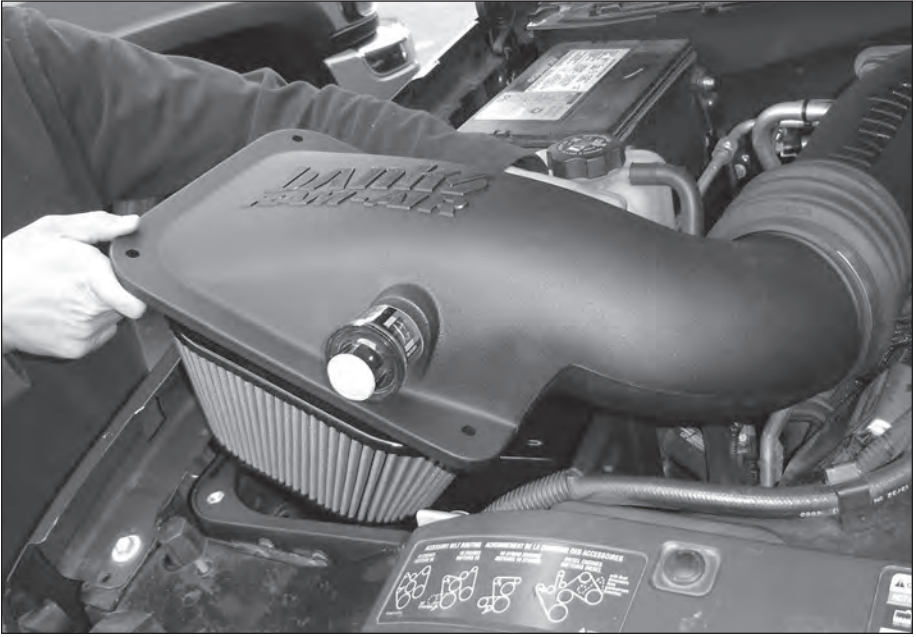
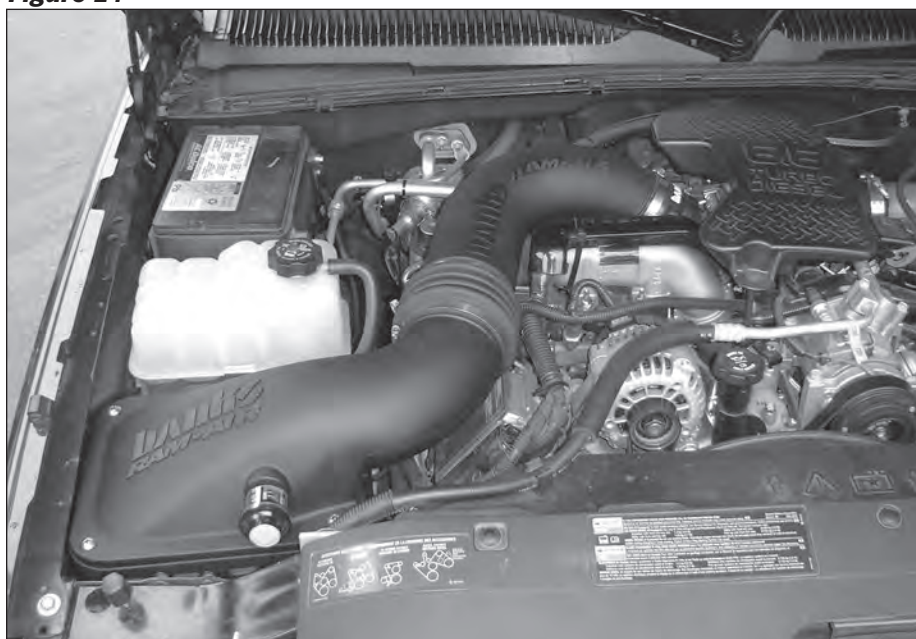

Figure 23



Figure 24



Section 3

AIR FILTER CLEANING INSTRUCTIONS

OILED AIR FILTER ONLY

NOTICE: The Banks Ram-Air Oiled Air Filter comes pre-oiled and no oiling is necessary for initial installation. Use Banks Ram-Air Filter Cleaning System (part#90094), available from Gale Banks Engineering to service the Air Filter. Follow the instructions included with the cleaning system to clean and re-oil your Bank Ram-Air Oiled Air Filter.

1. PRE-CLEANING

Tap the element to dislodge any large embedded dirt, then gently brush with a soft bristle brush. *NOTE: If complete cleaning is not practical at this time, reoil the element and reinstall in your vehicle.*

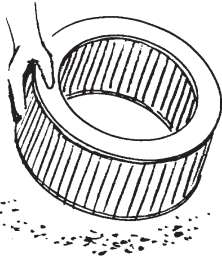

2. SPRAY-ON CLEANING

Spray air-filter cleaner liberally onto the entire element and let soak for 10 minutes.

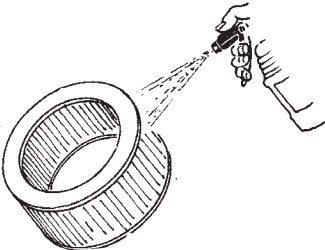

3. PAN CLEANING

Large air-filter elements can be rolled or soaked in a shallow pan of air-filter cleaner. Remove immediately and let soak for approximately 10 minutes.

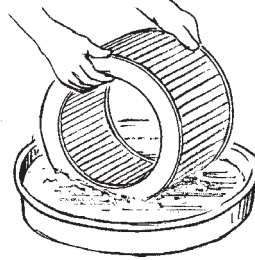

NOTICE: NEVER use gasoline, steam, caustic solutions, strong detergents, high-pressure nozzles, or cleaning solvents to clean the filter element. All of these can cause harm to the filter media as well as SHRINK and HARDEN the rubber end caps.

4. RINSING

Rinse off the element with low-pressure water. Tap water is okay. Always flush from the clean side to dirty side. This removes the dirt and does not drive it into the filter.

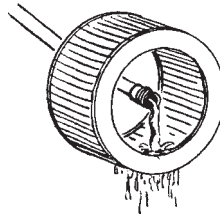

5. DRYING

Always dry naturally. After rinsing, shake off all excess water and let the element dry naturally.

6. AEROSOL OILING

After cleaning air filter always reoil before using. Spray air filter oil down into each pleat with one pass per pleat. Wait 10 minutes and re-oil any white spots still showing.

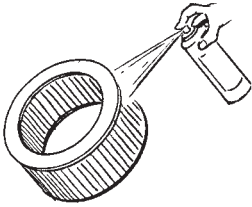

7. OILING HINTS

Never use a Banks Ram-Air filter without oil (the filter will not stop the dirt without the oil). Use air filter oil. Air-filter oil is a compound of mineral and animal oil blended with special polymers to form a very efficient tack barrier. Red dye is added to show just where you have applied the oil. Eventually the red color will fade but the oil will remain and filter the air. NEVER USE Automatic Transmission Fluid. NEVER USE Motor Oil. NEVER USE Diesel Fuel. NEVER USE WD40, LPS, or other light-weight oils.

8. REINSTALL

Reinstall your Banks Ram-Air filter element with proper care. Make sure the element seats properly in the filter case. Install the cover making sure it's in the right position. Tighten all the nuts, bolts, screws or clips to factory specifications.

9. DO NOT DISCARD

Affix the "Do Not Discard" sticker to the filter case (included with every Banks replacement element). Make sure you put the sticker in a highly visible place to alert your mechanic not to discard.

10. PERFORMANCE HINTS

Service every 50-100,000 miles on street-driven applications. Service more often in offroad or heavy-dust conditions. If an air-filter restriction gauge is installed, then change the element when the air-filter restriction reaches 18"-H.O.

⚠ CAUTION: Extremely fine dust from agriculture or offroad use will pull the oil from the element. Frequent reoiling of the element's clean side might be required. Completely service when practicable. For extra protection use an air-filter sealing grease on rubber ends of the element. Service only with air-filter cleaner and air-filter oil.

DRY FILTER CLEANING

Clean every 50-100,000 miles on street-driven applications. Clean more often in offroad or heavy-dust conditions. If an air-filter restriction gauge is installed, then change the element when the air-filter restriction reaches 18"-H.O.

1. PRE-CLEANING

Carefully tap the air filter element to dislodge any large embedded dirt or debris.

2. CLEANING

Spray an appropriate DRY AIR-FILTER CLEANER SOLUTION liberally onto both sides of the entire filter element with the majority applied to the dirty side. Soak for 10 minutes. Do not allow the DRY AIR-FILTER CLEANER SOLUTION to dry on the air filter.

NOTICE: NEVER use gasoline, steam, caustic solutions, strong detergents, high-pressure nozzles, or cleaning solvents to clean the filter element. All of these can cause harm to the filter media as well as SHRINK and HARDEN the rubber end caps.

3. RINSING

Rinse the filter element with cool or warm (not hot) water from the clean side out in order to flush the dirt out of the filter. It may be necessary to use your fingers on the hose to apply light water pressure. Repeat steps 2 and 3, until the water flowing through the media is completely clear of any dirt and debris.

5. DRYING

After rinsing, gently shake off excessive water and allow to dry naturally. Re-install the filter onto the intake system, airbox or custom assembly once it is

dry or just slightly damp. Follow all original installation instructions.

6. REINSTALL

Reinstall your Banks Ram-Air filter element with proper care. Make sure the element seats properly in the filter case. Install the cover making sure it's in the right position. Tighten all the nuts, bolts, screws or clips to factory specifications.

7. DO NOT DISCARD

Affix the "Do Not Discard" sticker to the filter case (included with every Banks replacement element). Make sure you put the sticker in a highly visible place to alert your mechanic not to discard.

8. PERFORMANCE HINTS

Service every 50-100,000 miles on street-driven applications. Service more often in offroad or heavy-dust conditions. If an air-filter restriction gauge is installed, then change the element when the air-filter restriction reaches 18"-H.O.

-END, SECTION 3-