



baja designs[®]
THE SCIENTISTS OF LIGHTING

**Ford Bronco (21+) Dual S1/S2 Reverse kit
With or w/o Optional license plate bracket
Instructions**



Ford Bronco 21+ Reverse kit Instructions

Tools Required

- 10mm and 1/2" Wrench (battery tools)
- 19mm, 17mm, 10mm and 8mm Sockets
- 3mm (S1) or 4mm (S2) Allen Wrench
- Trim tool (Preferred), or Flathead screwdriver
- 7/16" wrench
- 3/4 Drill (non-upfitter models)
- Pliers
- Electrical tape

1. To begin, place the vehicle in park, turn off and disconnect the negative battery terminal (1/2" wrench).
2. With the 19mm socket wrench, remove one lug nut and replace with the provided longer lug nut with the 17mm socket. Repeat for the other two lug nuts and place the OEM lug nuts aside. (Note: add a 17mm socket to your spare tire tools)



3. Extra washers are included with this kit to allow a small amount of adjustment for different wheel styles/offsets. The included 19mm hex bolts are M12 x 1.5 x 40mm. Mockup the reverse bracket with the top flange facing away from the spare tire. Determine the correct number of washers needed in-between the bracket and lug nuts are needed to clear the wheels. Tighten the bolts.

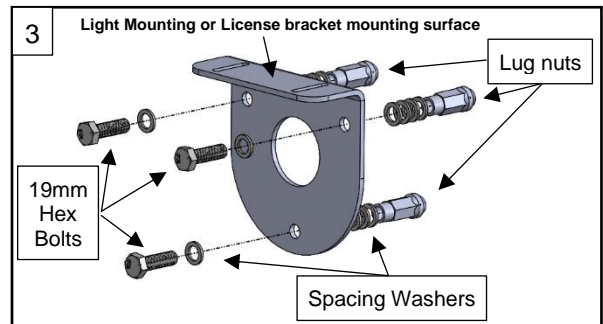

4. **License plate version for this step only:** Using the 7/16" wrench and socket with the provided 7/16" hex head hardware, mount the license plate bracket with the vertically aligned bolts shown on the right. With the other two bolts, mount the license plate in the lower holes. The upper two holes will use the stud LEDs to illuminate the license plate.

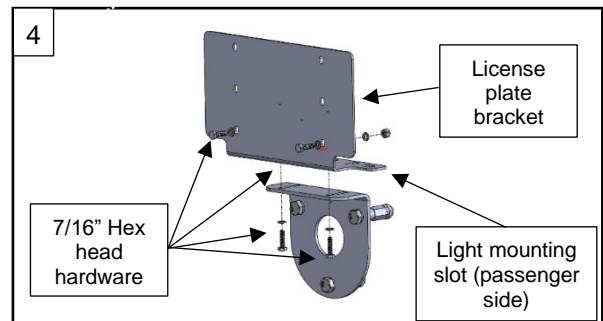

5. Assemble the lights referencing the exploded view drawings on the right. The S1 will need a 3mm Allen wrench and the S2 will need a 4mm Allen wrench.

Note: kits including the license plate will have the lights mounted with the brackets on top. Without the license plate, brackets will mount on the bottom of the lights.

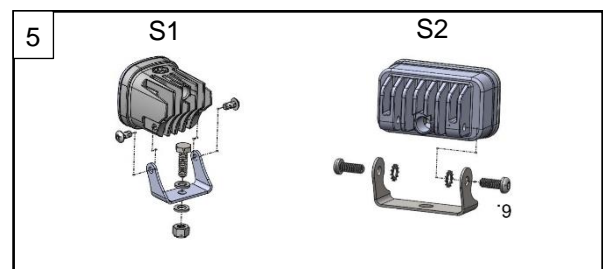

With the 7/16" wrench and socket, mount the lights onto the reverse light mounting locations corresponding to the kit version you purchased. The 7/16" hex head hardware is included. The correct mounting locations are shown on the right. 7/16" hex head hardware is provided.

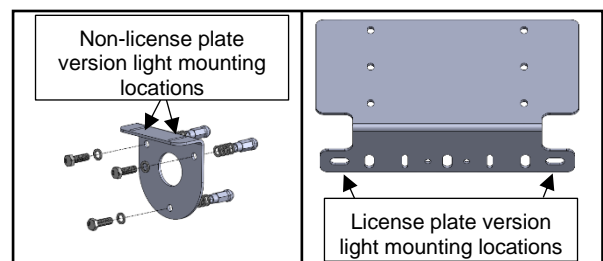

6. Locate the included small splitter. Attach it to one of the light power cords and attach the included 10ft extension. Thread the extension harness through the wheel spokes and out the bottom between the swing gate and the spare tire. Push the slack of the harness back up into the wheel as needed to grab the harness from the other wheel spoke opening behind the second light. Attach the second light's connector to the splitter harness. Tie all the connectors of the splitter harness together with a zip tie to take up a small amount of slack. Pull the extension back down in between the spare and the swing gate with the light power cord slack inside the wheel.

6



7. Open the swing gate as far as you can. Pull the extension harness slack down below the spare tire and then gently pull it taut and parallel to the gas strut. Use a zip tie to tie the harness to the thicker part of the strut shown. Add two more zip ties in the locations shown with the harness tight against the strut.



8. Thread the harness in-between the bumper and the body on the right side of the strut hinge as shown. Zip tie the harness to the bottom side of the strut hinge.

9. Route the harness across the back of the bumper. Locate the harness that follows the driver's side frame rail. Route the extension along the OEM harness. Zip tie wires away from hot, sharp, and/or rotating components.

8



10. The main harness (upfitter or toggle switch) will need to be unraveled. Route the light lead of the harness down the driver side firewall away from any hot, sharp, and/or rotating components. Continue routing the harness until it reaches the 10ft extension. Connect the main harness lead to the extension. Remove the slack and tie the harness as needed, pulling up into the engine compartment. Any extra harness length can be tied up and placed into the inner driver side fender.

11

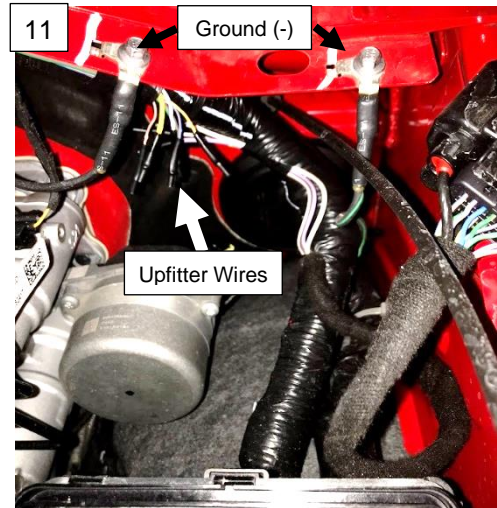

11. If you purchased the Upfitter switch version:

- Locate the bundle of upfitter wires in the back driver side corner taped to the large wiring harness. Pull the tape off to access the wires.
- Reference the table to choose a switch location. We prefer #6 for reverse lighting, but any of the switches will power this kit.
- Using the pliers, clasp the splice connector on the upfitter splice harness over the desired wire/circuit. Wrap the tape back over the remaining wires. Make sure all wires are isolated and add electrical tape as needed.
- Mount the black ring terminal of the splice harness to the common ground on the driver side firewall using a 10mm socket wrench.
- Reattach battery ground (-).

Power Distribution Box	Wire Color	Wire Size	Fuse
AUX 1	Yellow	1.5 mm ²	30A
AUX 2	Green/Brown	1.5 mm ²	15A
AUX 3	Violet/Green	0.75 mm ²	10A
AUX 4	Brown	0.75 mm ²	10A
AUX 5	Blue/Orange	0.75 mm ²	10A
AUX 6	Yellow/Orange	0.75 mm ²	10A

12. If you purchased the stand-alone toggle switch version:

- Locate the firewall passthrough grommet on the right side of the brake booster. In the cab, this will be located next to the footrest. Push grommet into engine compartment from the cab.
- There are two easy options for switch locations on the dash in the locations arrowed under the headlight controls.
- Gently pull dash panel away until unclipped. Locate the two circled indentations on the back of the dash below the headlight controls. These are the two suggested switch mounting locations.
- Snap a photo of the switch wiring for reference later. Remove the switch terminals from the switch. Remove the tape around the wires on either side of the grommet.
- Choose the desired dash location for the switch. Drill 3/4" hole.
- Thread the wires through the hole in the passthrough grommet, mount switch, and reattach switch terminals. Tape around the wires of the grommet. Install dash panel.
- Mount the (+) and (-) ring terminals of the harness to the corresponding battery terminals starting with the (+) red lead.
- Reattach battery ground (-)

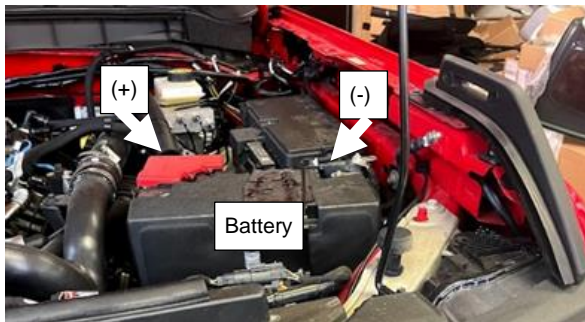
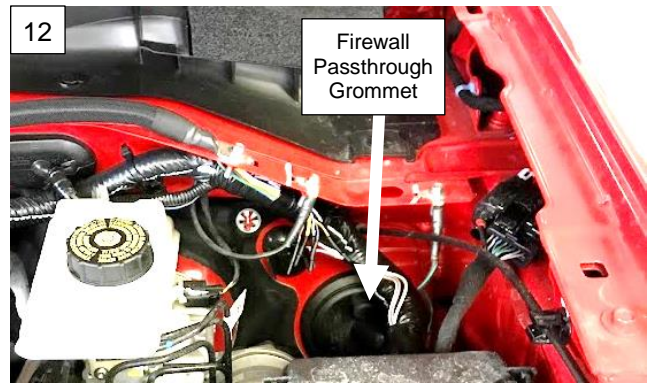

The following steps are for the license plate version only:

13. Open the swing gate and flip up the floor. With the flathead or trim tool, carefully pull up on the rear floor trim piece to unclip and set aside.
14. Now, carefully pull up on the bottom edge of the passenger side inner panel to unclip. At the top of the panel, remove the small plastic that wraps around the roll bar (Second image). Now carefully pull the rest of the panel toward the center of the vehicle in the directions shown. Some clips may stay attached to the body. Remove them and place them back onto the inside of the panel.

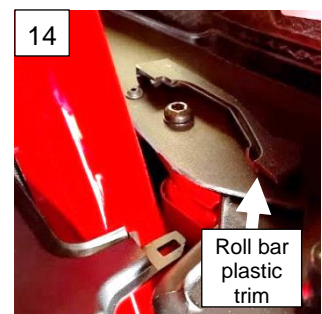
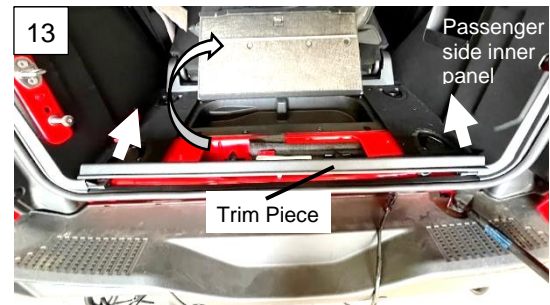

15. With the trim tool, remove the two panels on the inside of the swing gate as shown.



16. From inside the swing gate, depress the detents on the wiring passthrough and push it out. (It is not required to remove the spare tire for these steps, but custom wheel and tire packages may differ)

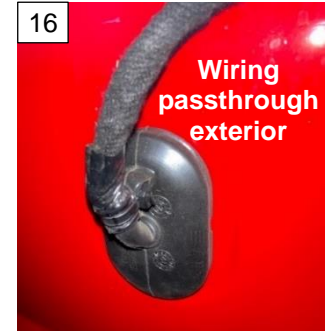

17. Locate the license plate LEDs in the small bag that came with the wiring harnesses. Remove the 10mm hex head nut from one LED stud and thread each wire, one at a time, through one of the upper license plate mounting holes. Thread the wires through the nut and tighten back to the LED stud. Repeat for the other LED. Make sure the LEDs are facing down.

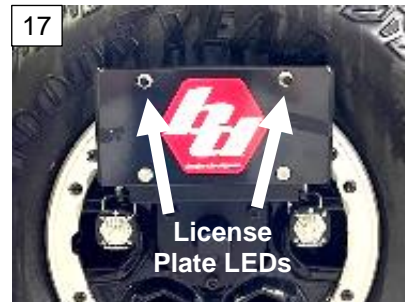

18. Male bullet covers are included in the same bag that the LEDs come in. Place them over each of the male bullet terminals on the LED wires. Some petroleum jelly, or silicone lubricant can help slide the covers on. Gently pull the LED wires together and zip tie them close to the back of license plate bracket. Then add another tie about 3/4" away from the end of the wires.

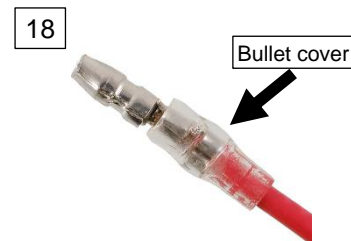

19. Locate the bigger harness that came with the license plate LEDs. Plug in each of the red and black wires from the license plate LEDs into the respective red or black female double bullet terminals (C) of the license plate harness. Thread the power and ground leads of the license plate harness (A,B) through the spare wheel behind the license plate bracket and out near the swing gate wiring passthrough.

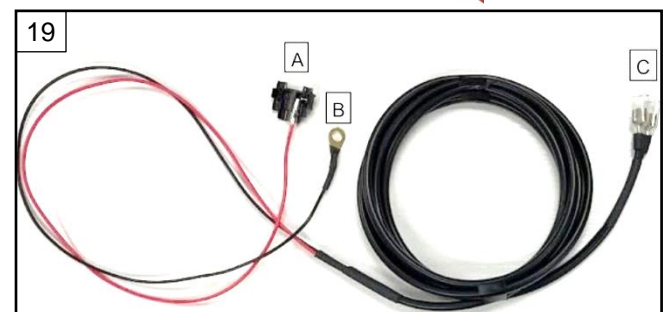

20. It may be helpful to remove the splice connector on the end of (A) momentarily. Remove the zip tie and tape on either side of the swing gate wiring passthrough. Thread the wires through, pull the slack into the swing gate, and replace the tape and zip tie.



Route the harness as shown through the inside of the swing gate, following the OEM harness.

21. Zip tie the license plate harness to the OEM swing gate harness as shown. Replace both the the swing gate panels from step 15.

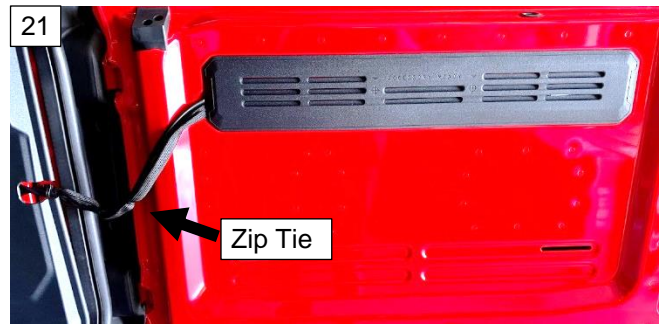

22. Inside the passenger side inner panel from step 14 is access to the passenger side taillight wiring.



23. With the splice terminal connected to the license plate harness on the male bullet connector (A), use pliers to clasp the splice onto the running light wire (Blue with grey stripe).



24. Use the 10mm socket to remove the common ground bolt, thread it through the ground ring terminal (B) of the license plate harness and tighten.



25. Replace the panels and trim pieces from steps 13-14.