



***baja designs***<sup>®</sup>  
THE SCIENTISTS OF LIGHTING

## Jeep JL and JT Dual LP4/LP6 Auxiliary Light Kit



## Jeep JL Auxiliary Light Kit Instructions

### Tools Required

- 16mm Wrench
- 7/16" Socket

1. To begin, use the trim tool, or a flathead screwdriver to remove the two plastic fasteners from the plastic panel in between the front grill and bumper. It will not be reused. Remove six more fasteners from the front edge of the panel.
2. With the 16mm wrench, remove the bumper mounting bolts on the inside and outside of the frame (Driver side only).
3. Mount the driver side bumper bracket on the inside of the frame rail with the flange pointed inward. Hand tighten the bolt. Then mount the bumper bracket support on the outside of the frame rail with the bolt hand tight. Use the 9/16" wrench and socket to tighten the 9/16" hex head hardware and tighten the brackets together snug. Tighten the frame bolts with the 16mm wrench with the top surface level. Repeat steps 1-3 for the passenger side.
4. Use the 7/16" socket to mount the LP lights to the standard LP brackets. With the provided hardware, mount the LP lights to the bumper bracket assemblies using the 9/16" wrench and socket.

- Trim Tool (Flathead Screwdriver)
- 9/16" Wrench and Socket

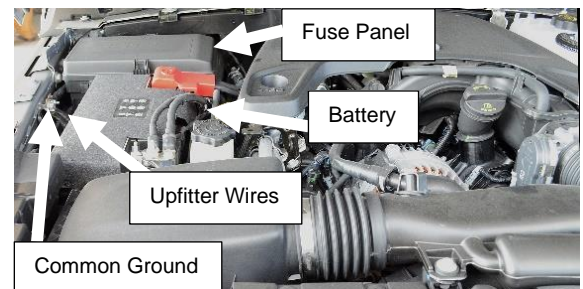
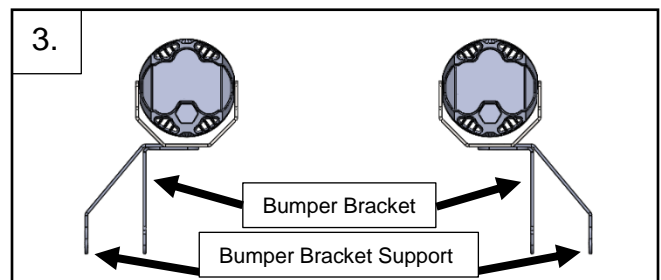
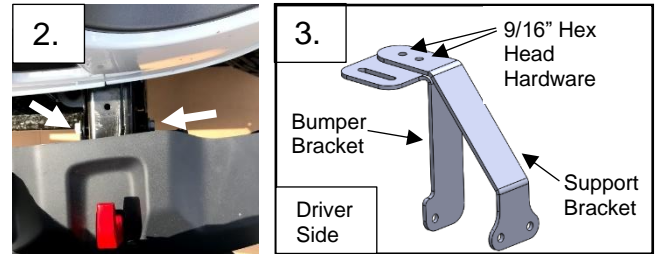

### LP4 Only Wiring Instructions

#### If you purchased the upfitter switch version:

- Route the light connector leads of the included harnesses from the engine compartment along the passenger side inner fender down and out through the front of the fender well. Plug in the light connectors.
- Route the opposite ends of the harnesses to the battery.
- Clasp the splice connector attached to the white wire over the desired upfitter wire (15A minimum). Clasp the splice connector attached to the yellow wire over another upfitter wire (1A minimum) or a DRL (Daytime Running Light) wire. Repeat for other light.
- Use the 10mm socket to remove the nut on the common ground stud, place the black wire ring terminal over the stud, and tighten.

#### If you purchased the stand-alone harness version:

##### **Automatic Transmission:**

- Route the light connector leads of the included harness from the engine compartment along the passenger side inner fender down and out through the front of the fender well. Plug in the light connectors. With the provided backlight wiring harness, follow the same route with the two terminal ends and plug them into each connector in the #3 pin.
- Route the opposite end of the harness to the battery and then route the switch lead along the firewall to the driver side near the brake booster. Route the opposite end of the backlight harness to the fuse panel.
- Reference included backlight harness instructions to attach micro fuse tap to the harness and the fuse tap to the fuse panel (F52, Cigarette lighter).
- Take a photo of the wires connected to the switch for reference later. Remove the grommet that seals the firewall passthrough and pierce a hole in the center.

- Remove the wires from the switch, thread wires through the grommet, route wires through the passthrough, and reinstall the grommet.
- Locate a desired dash location for the switch and confirm that there is clearance behind. Drill hole, thread wires through, attach the switch, and mount the switch.

- Use 10mm socket to attach ring terminals to the battery. (+) Red lead first and (-) Black lead second.

**Manual Transmission:**

- Route the light connector leads of the included harness from the engine compartment along the passenger side inner fender down and out the front of the fender well. Plug in the light connectors. With the provided backlight wiring harness, follow the same route with the two terminal ends and plug them into each connector in the #3 pin.
- Route the opposite end of the harness to the battery and then route the switch lead to the bottom of the passenger side inner fender well. Route the opposite end of the backlight harness to the fuse panel.
- Reference included backlight harness instructions to attach micro fuse tap to the harness and the fuse tap to the fuse panel (F52, Cigarette lighter).
- Outside the passenger side inner fender well, remove the two plastic fasteners to access the inner passenger side firewall.
- Locate the arrowed electronic module. With the 10mm socket wrench, remove the nuts and move it toward the center of the firewall out of the way momentarily. Press in on the harness grommet on the firewall until the grommet seal is broken and the inside of the cab is breached. (Second image on right)
- Snap a photo of the switch wiring. Remove the switch terminals from the switch, route switch wires through.
- Pull the slack from the switch lead into the cab from under the glovebox in the arrowed location. Pull the grommet back into the engine compartment and/or push from inside the cab to seal the grommet.
- Mount the electronic module back to the firewall.
- Route the switch lead behind the dash over to the driver side.
- Locate a desired dash location for the switch and confirm that there is clearance behind. Drill hole, thread wires through, attach the switch, and mount the switch.
- Using the 10mm socket wrench, mount the (+) and (-) ring terminals of the harness to the corresponding battery terminals starting with the (+) red lead.

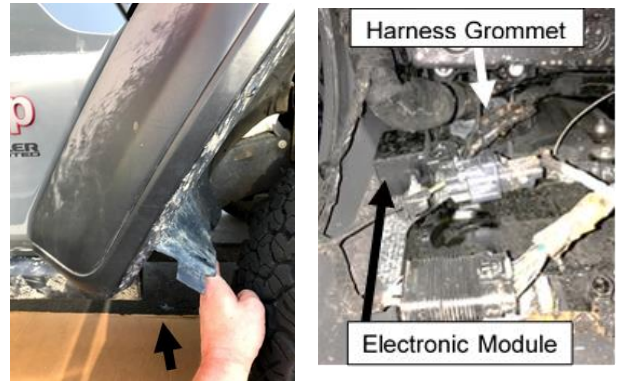
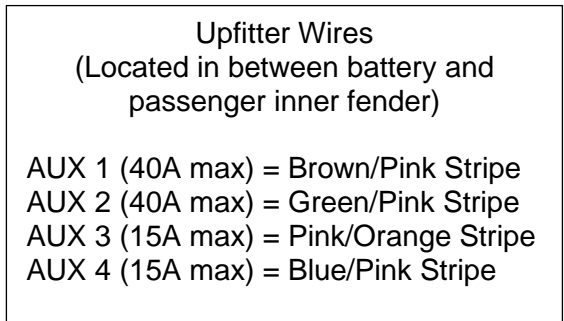
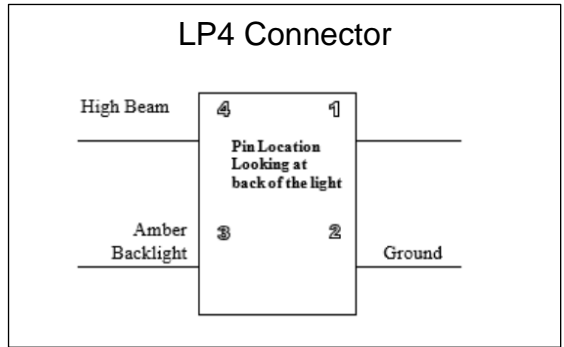

**LP6 Only Wiring Instructions**

If you purchased the upfitter switch version:

- Route the light connector leads of the included harness from the engine compartment along the passenger side inner fender down and out through the front of the fender well. Plug in the light connectors.
- Route the opposite end of the harness to the battery.
- Clasp the splice connector attached to the white wire over the desired upfitter wire (16A minimum). Clasp the splice connector attached to the yellow wire over another upfitter wire (1A minimum) or a DRL (Daytime Running Light) wire.
- Use 10mm socket to attach ring terminals to the battery. (+) Red lead first and (-) Black lead second.

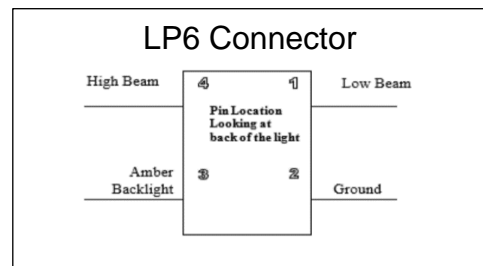

If you purchased the stand-alone harness version:

**Automatic Transmission:**

- Route the light connector leads of the included harness from the engine compartment along the passenger side inner fender down and out through the front of the fender well. Plug in the light connectors. With the provided backlight wiring harness, follow the same route with the two terminal ends and plug them into each connector in the #3 pin.
- Route the opposite end of the harness to the battery and then route the switch lead along the firewall to the driver side near the brake booster. Route the opposite end of the backlight harness to the fuse panel.
- Reference included backlight harness instructions to attach micro fuse tap to the harness and the fuse tap to the fuse panel (F52, Cigarette Lighter).
- Take a photo of the wires connected to the switch for reference later. Remove the grommet that seals the firewall passthrough and pierce a hole in the center.
- Remove the wires from the switch, thread wires through the grommet, route wires through the passthrough, and reinstall the grommet. Locate a desired dash location for the switch and confirm that there is clearance behind. Drill hole, thread wires through, attach the switch, and mount the switch.
- Use 10mm socket to attach ring terminals to the battery. (+) Red lead first and (-) Black lead second.

**Manual Transmission:**

- Route the light connector leads of the included harness from the engine compartment along the passenger side inner fender down and out through the front of the fender well. Plug in the light connectors. With the provided backlight wiring harness, follow the same route with the two terminal ends and plug them into each connector in the #3 pin.
- Route the opposite end of the harness to the battery and then route the switch lead to the bottom of the passenger side inner fender well. Route the opposite end of the backlight harness to the fuse panel.
- Reference included backlight harness instructions to attach micro fuse tap to the harness and the fuse tap to the fuse panel (F52, Cigarette lighter).
- Outside the passenger side inner fender well, remove the two plastic fasteners to access the inner passenger side firewall.
- Locate the arrowed electronic module. With the 10mm socket wrench, remove the nuts and move it toward the center of the firewall out of the way momentarily. Press in on the harness grommet on the firewall until the grommet seal is broken and the inside of the cab is breached. (Second image on right)
- Snap a photo of the switch wiring. Remove the switch terminals from the switch, route switch wires through.
- Pull the slack from the switch lead into the cab from under the glovebox in the arrowed location. Pull the grommet back into the engine compartment and/or push from inside the cab to seal the grommet.
- Mount the electronic module back to the firewall. Route the switch lead behind the dash over to the driver side.
- Locate a desired dash location for the switch and confirm that there is clearance behind. Drill hole, thread wires through, attach the switch, and mount the switch.
- Using the 10mm socket wrench, mount the (+) and (-) ring terminals of the harness to the corresponding battery terminals starting with the (+) red lead.

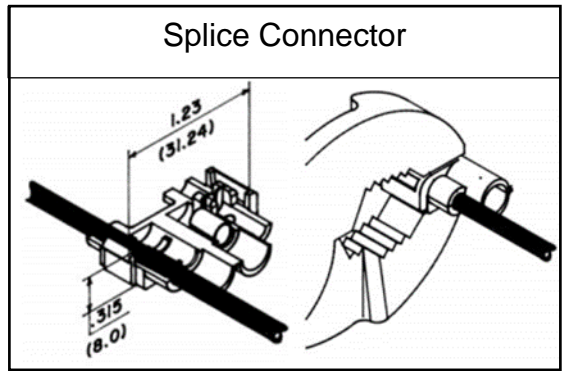

**Tie all wires away from sharp, hot, and/or rotating components.**

**Re-torque all the fasteners after 100 miles.**

**Your install is now complete! Thank you for choosing Baja Designs.**