

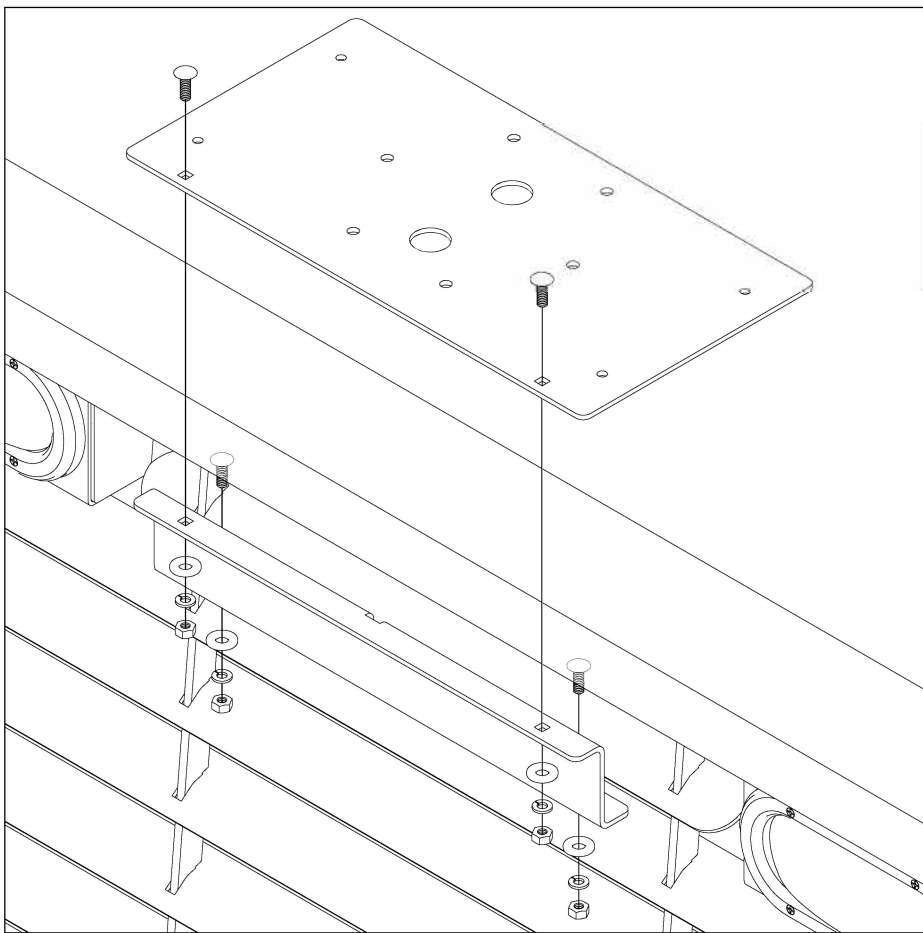





CPXA6001B & CPXA6001W

Cab Protector™ Light Bar accessory

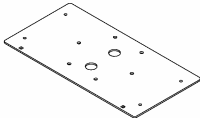
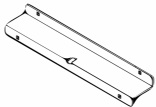

HARDWARE LIST		QTY.
	1/4" CARRIAGE BOLT	4
	1/4" WASHER	4
	1/4" LOCK WASHER	4
	1/4" NUT	4
LIGHT BAR PLATFORM		
		1
LIGHT BAR BRACKET		
		1

EXAMPLES OF POSSIBLE INSTALL SCENARIOS.

