

CAT-BACK EXHAUST INSTALLATION GUIDE: 2018+ AUDI RS3

Thank you for purchasing the **AWE SwitchPath™** or **Track Edition Exhaust System** for the **2018+ Audi 2.5T RS3**.

Let's go!

These instructions are intended for the following part numbers: **3025-33030, 3020-33056**

PARTS LIST



INSPECT ALL PARTS PRIOR TO DISASSEMBLY OF VEHICLE; IF DAMAGED OR MISSING, PLEASE CONTACT THE PLACE OF PURCHASE IMMEDIATELY.

QTY	Description	Part Number
1	Rear merge inlet tube	A61
1	Mid merge	B97
1	Driver side tip outlet	C48
1	Passenger side tip outlet	C49
1	Rear branch section	C03
2	2.5" Accu-Seal clamp	TAS250
4	3.0" Accu-Seal clamp	TAS300
1	Driver side RS oval tip	61000453
1	Passenger side RS oval tip	61000454
Integrated tip hardware kit (3910-41010)		
4	1/4-20 x 3/4" carriage bolt	1010-1003-4
4	1/4-20 flanged locknut	90949A016
Switchpath System Only		
1	Driver side SwitchPath™ muffler section	B98
1	Passenger side SwitchPath™ valve section	B99
1	SBS valve motor simulator	150004
1	Valve simulator dowel pin	98380A457
3	7.5" cable tie	7130K59
Track System Only		
1	Driver side track rear leg	C04
1	Passenger side track rear leg	C05
2	SBS valve motor simulator	150004
2	Valve simulator dowel pin	98380A457
4	7.5" cable tie	7130K59

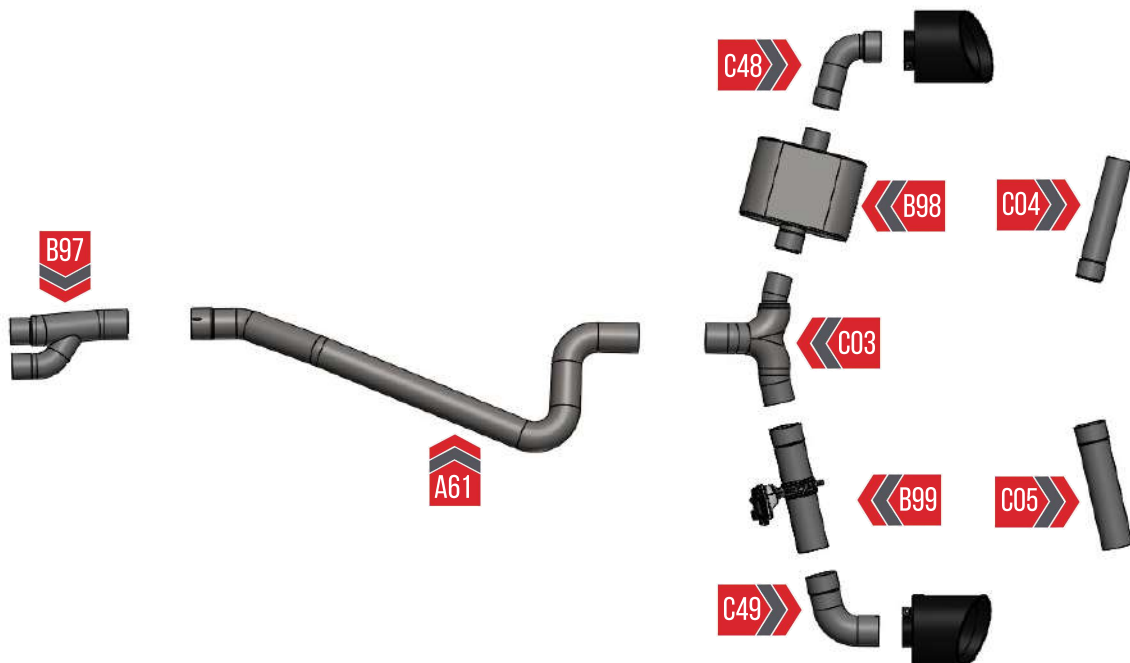



PRIOR TO INSTALLATION:

- If the AWE Secondary Cat Delete System (3010-11092) has been purchased, be sure to complete that installation prior to installing this system.
- If the valve motors have been operating while disconnected from the factory valve body, re-index the valve motors by reinstalling them back onto the factory exhaust, start the vehicle and cycle through the “drive select” modes.

STEP 1



Installation of the AWE Performance Exhaust System is the reverse of the removal OEM exhaust.



Always refer to the manufacturer service manual for precise torque specifications on all OEM fasteners.

With the car lifted, locate and unplug the factory valve control harnesses from the factory valve control motors, locations shown by the arrows in **Figure 1**.



WARNING: Allow the exhaust ample time to cool, serious injury and burns can occur if handled incorrectly.

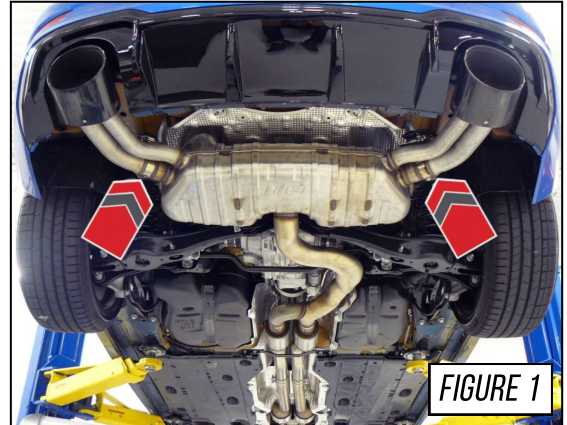

FIGURE 1

STEP 2



NOTE: Prior to exhaust removal, be sure the system is properly supported with pole jacks or an extra set of hands.

Locate and loosen the factory sleeve clamps, shown by **Arrows A** in **Figure 2**.

Do not slide the clamps forward until the remainder of the system is ready to be removed.

Remove the cross-brace, shown by **Arrow B** in **Figure 2**.



FIGURE 2

STEP 3

Locate and remove the hanger from the hanger bushings, locations shown by the arrows in **Figure 3**.



NOTE: Use a penetrant oil to spray onto the hangers where they are hung in the rubber bushing, this will help with removal.

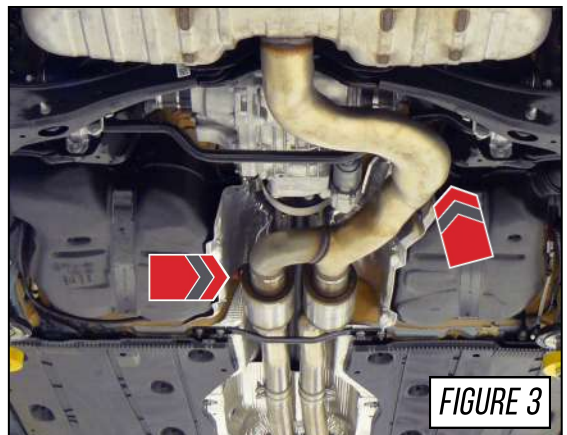

FIGURE 3

STEP 4

With the entire system supported, loosen and remove the bolts that secure the hangers on either side of the muffler.

The arrow in **Figure 4-1** shows the location of the passenger side hanger bolt.



The arrow in **Figure 4-2** shows the location of the driver side hanger bolt.

Slide the sleeve clamps, loosened in *Step 2*, rearward towards back end of the car.

Remove the OE exhaust from the car.

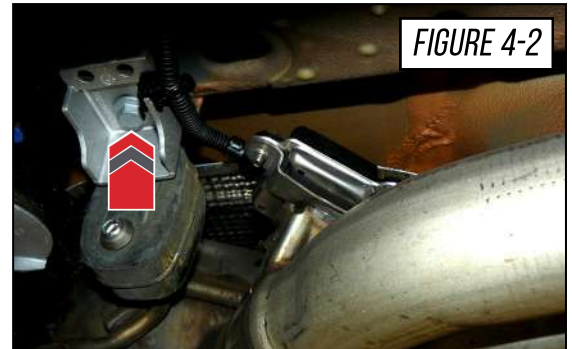

WARNING: The axle-back section of the OE exhaust is best handled by two (2) people.

STEP 5

Installing the AWE Performance Exhaust:

Reuse the OEM sleeve clamps to install the mid-pipe merge section (*part A60*), as shown by **Arrows A** in **Figure 5**.

Use one of the included 3.0" Accu-Seal clamps to slip over the inlet side of the axle tube (*part A61*), and install onto the outlet of the merge section, as shown by **Arrow B** in **Figure 5**.

Do not torque any clamps until the final step, after the entire system has been installed and adjusted to satisfaction.

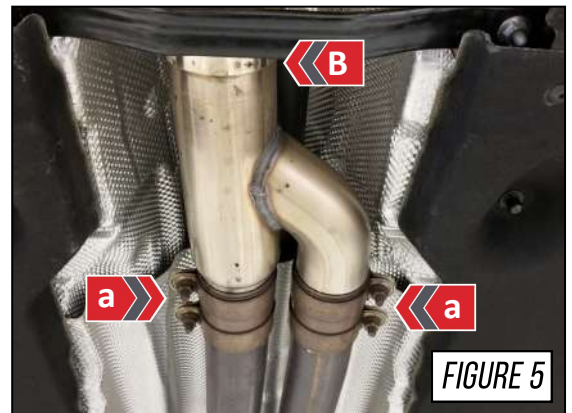

STEP 6

Use one of the included 3.0" Accu-Seal clamps to slip over the inlet side on the axle Tube (*part A61*), install onto the outlet of the merge section, as shown by **Arrow A** in **Figure 6**

Reinstall the hanger brackets back into their factory locations and insert the hangers on the axle tube

At this point the chassis brace can be reinstalled using the factory hardware, as shown by **Arrow B** in **Figure 6**

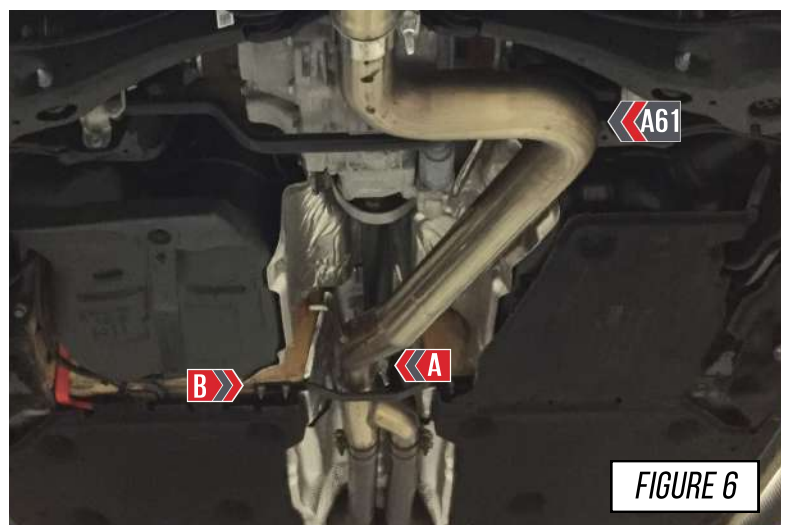

STEP 7

Use one of the included 3.0" Accu-Seal clamps to install the rear branch tube (part C03) as seen in **Figure 7**

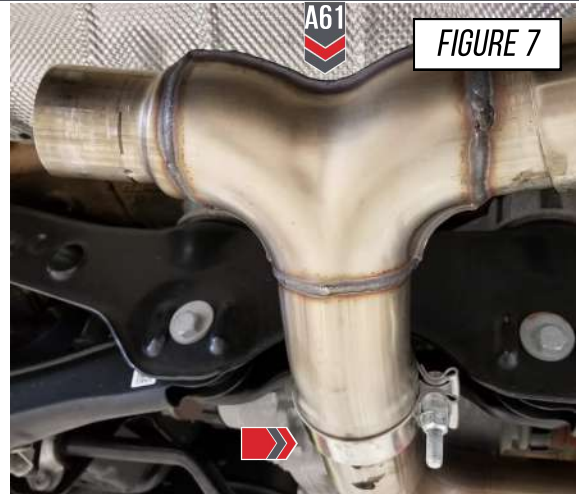

STEP 8

Continue by installing the drivers side rear leg section (part B98 for Switchpath and C04 for track) with the supplied 2.5" Accu-Seal clamps.

Next, install the drivers side tip outlet (part C48) onto the drivers side rear leg.

Make sure to slide the clamps over the tubes before installing onto the vehicle

Install the hangers on the rear leg into the factory hanger location as seen in **Figure 8**



STEP 10

For SwitchPath™ Installation:

Transfer the factory valve motor to the bracket located on the passenger side tailpipe section, and reconnect the factory harness.

Using the factory hardware, install the driver side motor onto the included MVS bracket and pin, as shown in **Figure 10-1**.

Install the MVS Bracket onto the factory valve motor, from the driver side tailpipe section of the OE exhaust, using the factory mounting bolts, as shown by **Arrow A** in **Figure 10-2**.

Use a cable-tie to secure the motor up and away from the exhaust and reconnect the factory harness, as shown by **Arrow B** in **Figure 10-2**.

Start the vehicle, and switch to Dynamic mode; confirm this opens the valve to verify proper operation.

PRO-TIP: A properly indexed OE valve motors is critical to a smooth installation. If the valve motors have been operating while disconnected from the factory valve body, re-indexing will be required.



FIGURE 10-1

For Track Edition Installation:

Remove the factory valve motors from each tailpipe section of the OE exhaust.

Install the MVS Bracket onto the factory valve motor, from the driver side tailpipe section of the OE exhaust, as shown by **Arrow A** in **Figure 10-2**.

Use a cable-tie to secure the motor up and away from the exhaust and reconnect the factory harness, as shown by **Arrow B** in **Figure 10-2**.

Reconnect the factory harnesses to the valve control motors and repeat MVS Bracket installation for the passenger side.

Installation is complete!

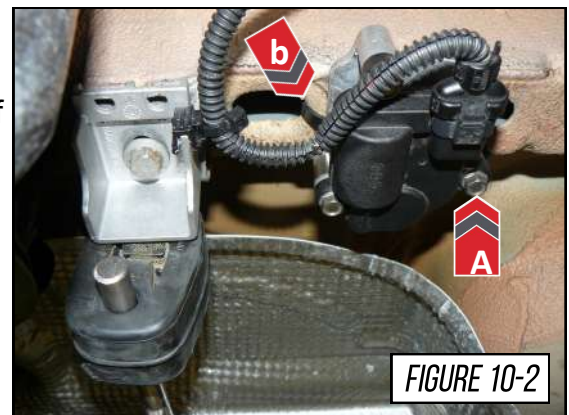

FIGURE 10-2

STEP 10

Continue with installing the passengers side rear leg section (part B94 for Switchpath and C05 for track) with the supplied 2.5" Accu-Seal clamps.

Install the drivers side tip outlet (part C49) onto the drivers side rear leg.

Make sure to slide the clamps over the tubes before installing onto the car

Make sure to install the hangers on the rear leg into the factory hanger location, as seen in **Figure 10**

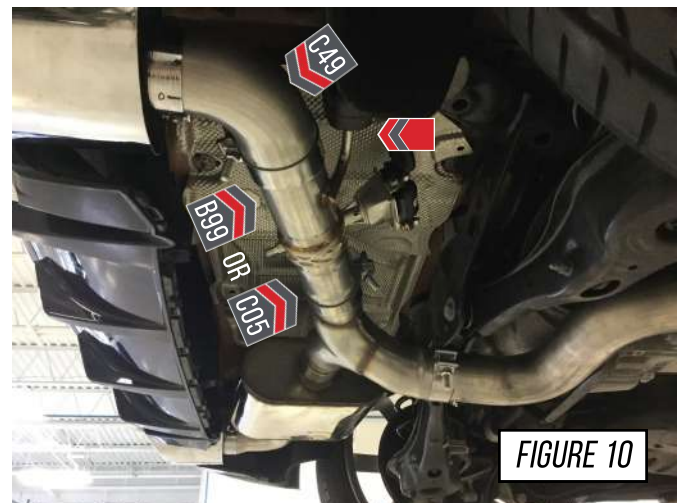

FIGURE 10

STEP 11

Use the included hardware to install the driver and passenger side RS tips as shown in **Figure 11**



STEP 12

It is crucial to install each section and Accu-Seal clamp correctly to prevent loose joints and exhaust leaks between the tubing connections.

Arrow A in **Figure 12** shows the expanded pipe and the preinstalled Accu-Seal clamp being brought up to the corresponding pipe.

Arrow B in **Figure 12** shows the overlapping pipe installed correctly over the corresponding pipe.

Arrow C in **Figure 12** shows the Accu-Seal clamp being brought to the edge of the expanded pipe.

NOTES:



- Do not torque any Accu-Seal clamp until the entire exhaust has been installed and adjusted.
- Torque specification is a minimum of 40 ft/lbs.

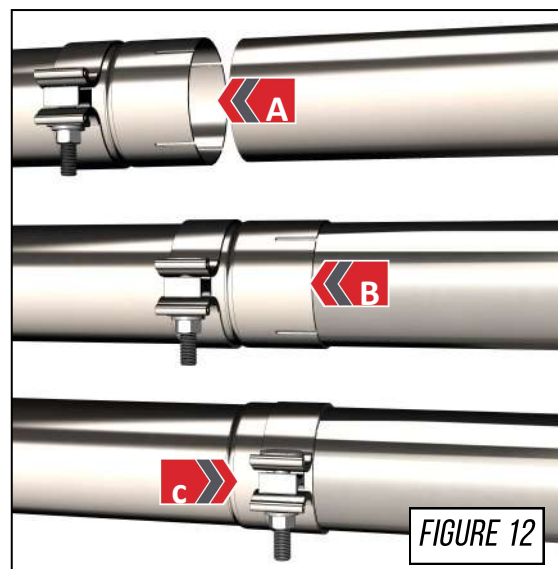

STEP 13

After the system has been properly installed in the factory exhaust hangers, and adjusted; begin torquing the clamps to lock everything into location.

Begin torquing from the forward most clamps and move gradually towards the rear of the vehicle.



PRO-TIP: Periodically check the tip alignment to ensure proper placement after torquing *each* Accu-Seal clamp.

Installation is complete!



ENJOY!





PERFORMANCE MID-PIPE INSTALL GUIDE: 2018+ AUDI RS3 & TTRS

Thank you for purchasing the **AWE Performance Mid-pipe System** for the **2018+ Audi 2.5T RS3**.
Let's go!

These instructions are intended for the following part numbers: **3010-11092**

PARTS LIST



INSPECT ALL PARTS PRIOR TO DISASSEMBLY OF VEHICLE; IF DAMAGED OR MISSING, PLEASE CONTACT THE PLACE OF PURCHASE IMMEDIATELY.

Performance Mid-Pipe Parts:

- | | |
|--|------------------|
| 1 Mid-pipe section - driver (<i>part A58</i>) | 2 Flange gaskets |
| 1 Mid-pipe section - passenger (<i>part A59</i>) | 6 M8 screws |
| | 6 M8 washers |
| | 6 M8 lock-nuts |

Hardware Kit:



NOTE: If the AWE Performance Cat-back System (*3025-33030 or 3020-33056*) has been purchased, complete the exhaust system removal before installing this system.



STEP 1



Installation of the AWE Performance Exhaust System is the reverse of the removal OEM exhaust.



Always refer to the manufacturer service manual for precise torque specifications on all OEM fasteners.

With the car lifted, loosen and remove the factory nuts that secure the secondary catalysts into position, locations shown by the arrows in **Figure 1**.



WARNING: Allow the exhaust ample time to cool, serious injury and burns can occur if handled incorrectly.

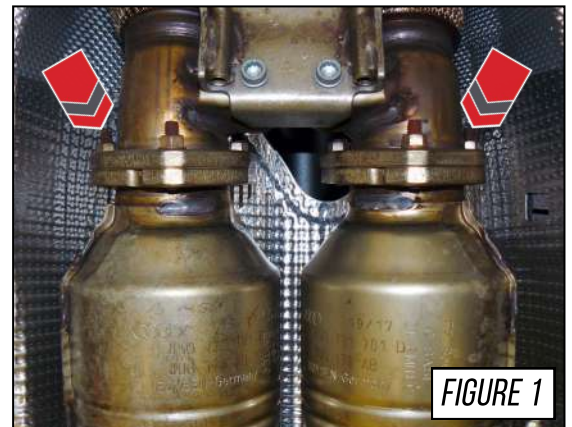

STEP 2



NOTE: If the cat-back system is being installed, the sleeve clamps and factory cat-back system should have already been removed. Proceed to *Step 3*.

Locate and loosen the factory sleeve clamps, shown by arrows in **Figure 2**.

Slide the clamps rearward to remove the factory mid-sections.



FIGURE 2

STEP 3

Using the included M8 hardware and new flange gaskets, install both driver (*part A58*) and passenger (*part A59*) performance mid-pipes, as shown by **Arrows A** in **Figure 3.2**.

Reuse the factory sleeve-clamps to secure the outlets into position, as shown by **Arrows B** in **Figure 3.2**.

Torque all hardware to factory specifications.

NOTES:



- If installing the AWE Performance Cat-back System, continue with the remainder of the installation process, starting at *Step 5* of the **Cat-back Installation Instructions**.
- The driver and passenger side mid-pipes are stamped with a “D” and “P”, as shown in the pre-production image of **Figure 3.1**. These letters face the ground when correctly installed.

Installation is complete!



FIGURE 3.1



FIGURE 3.2

ENJOY!

