



INSTALLATION GUIDE: AWE RS 5 SPORTBACK TRACK OR TOURING EXHAUST

THIS PRODUCT IS INTENDED FOR THE FOLLOWING VEHICLES*:

YEAR	MAKE	MODEL	SUBMODEL	ENGINE
2018-19	Audi	RS 5	Sportback	2.9T

THIS GUIDE IS INTENDED FOR THE FOLLOWING PART NUMBERS:

- 3015-33114 AWE Touring Edition Exhaust for Audi B9 RS 5 Sportback - Non-Resonated
- 3015-33116 AWE Track Edition Exhaust for Audi B9 RS 5 Sportback - Resonated for Performance Catalysts
- 3015-33118 AWE Touring Edition Exhaust for Audi B9 RS 5 Sportback - Resonated for Performance Catalysts
- 3020-33060 AWE Track Edition Exhaust for Audi B9 RS 5 Sportback - Non-Resonated
- 3815-31010 AWE Touring Edition Conversion Kit for Audi B9 RS 5 Sportback
- 3820-31008 AWE Track Edition Conversion Kit for Audi B9 RS 5 Sportback

Welcome to the AWE family, and congratulations on your purchase of the **AWE Track Edition or Touring Edition Exhaust** system for the B9 RS 5 Sportback.

Exquisite build quality and craftsmanship, coupled with industry leading performance, distinguish this exhaust system from all others.

*For up to the minute fitment information, be sure to visit the AWE website.

PARTS LIST



INSPECT ALL PARTS PRIOR TO DISASSEMBLY OF VEHICLE; IF DAMAGED OR MISSING, PLEASE CONTACT THE PLACE OF PURCHASE IMMEDIATELY.

General Hardware

QTY	Description	Part Number
2	B9 2.9T downpipe gasket	8W0253115K
2	SBS valve simulator	150004
2	Valve motor pins	98380A457
8	3.00" Accu-Seal clamps	TAS300
4	Chassis brace spacer	Z260029-SS
1	B9 Center Brace	120019

Integrated Clamp Hardware Kit (3910-41010)

QTY	Description	Part Number
4	1/4-20x 3/4" Bolt	1010-1003-4
4	1/4-20" locknut	90949A016

B9 2.9T Hardware Kit (3910-41020)

QTY	Description	Part Number
6	M8x30 screws	91287A154
6	M8 locknut	94920A500

TOURING EDITION PARTS LIST



INSPECT ALL PARTS PRIOR TO DISASSEMBLY OF VEHICLE; IF DAMAGED OR MISSING, PLEASE CONTACT THE PLACE OF PURCHASE IMMEDIATELY.

QTY	Description	Part Number
1	Driver side downpipe upper section	B49
1	Passenger side downpipe upper section	B50
1	Driver side non-res downpipe lower section	B79
1	Passenger side non-res downpipe lower section	B80
1	Sportback X-pipe section	B92
1	Driver side Sportback axle tube	B91
1	Passenger side Sportback axle tube	B93
1	AWE driver side RS oval tip diamond black	61000204-BLK
1	AWE passenger side RS oval tip diamond black	61000205-BLK
Track Edition Only		
1	Driver side Sportback track rear section	B94
1	Passenger side track rear section	B55
Touring Edition Only		
1	Driver side Sportback touring Rear Section	B95
1	Passenger side touring Rear Section	B76
Optional resonators for performance downpipes		
1	Driver resonated downpipe lower section	B81
1	Passenger resonated downpipe lower section	B82

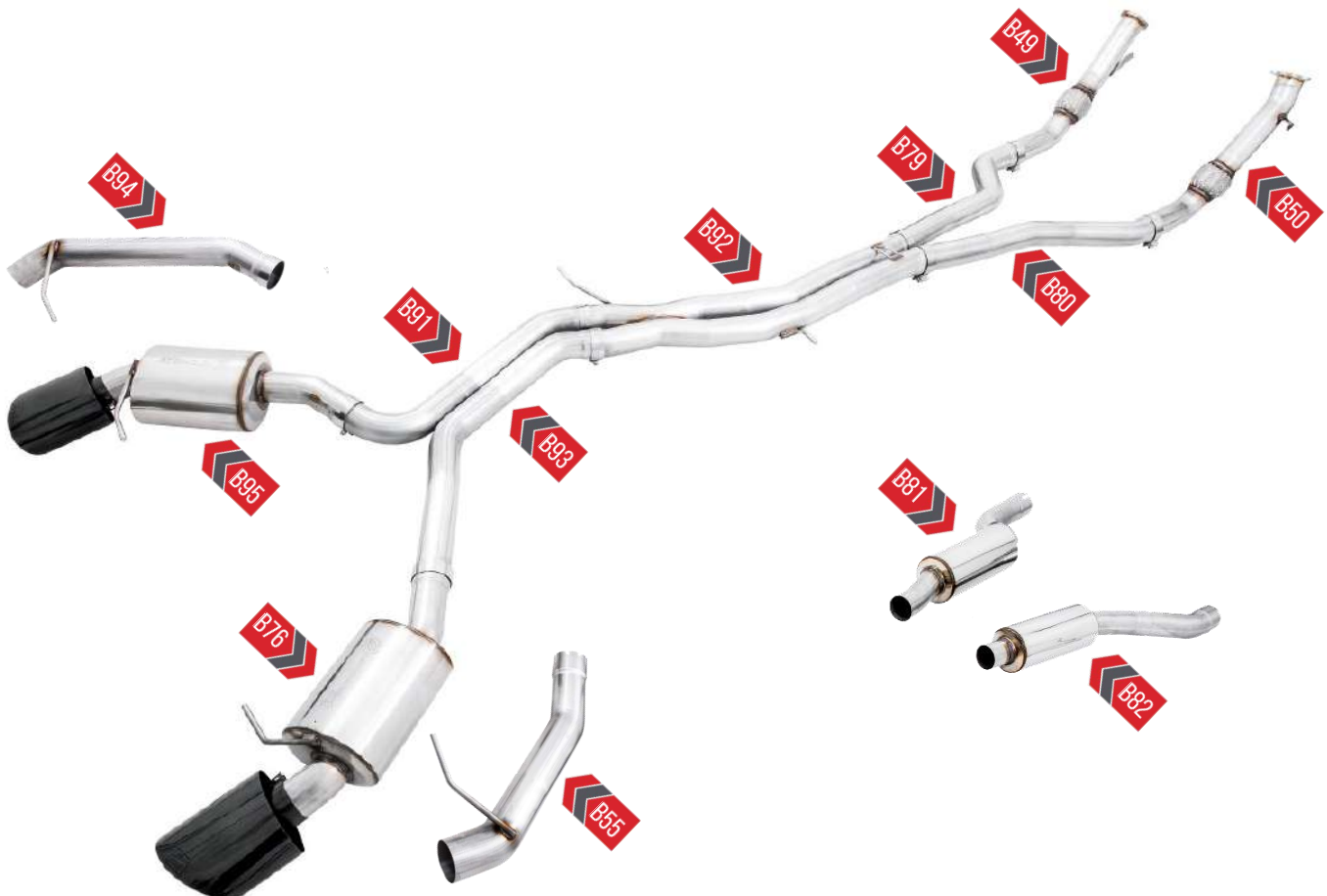

STEP 1



Installation of the AWE exhaust system is the reverse of the removal OEM exhaust.



Always refer to the manufacturer service manual for precise torque specifications on all OEM fasteners.

Under the hood, remove the plastic engine cover and turbo heat shield, to expose the turbos and catalyts.



CAUTION: The catalyts may be **VERY HOT** — allow adequate time for these to cool down before disassembly. Severe burns and injury will occur if skin comes into contact with a hot exhaust and/or catalyts.

Before exhaust removal, soak the fasteners that hold the exhaust in place with a penetrating oil.

Start by removing the 12mm nut on the driver side flange, shown by the arrow in **Figure 1-1 & 1-2**. This is the only nut that can be accessed from the engine bay.

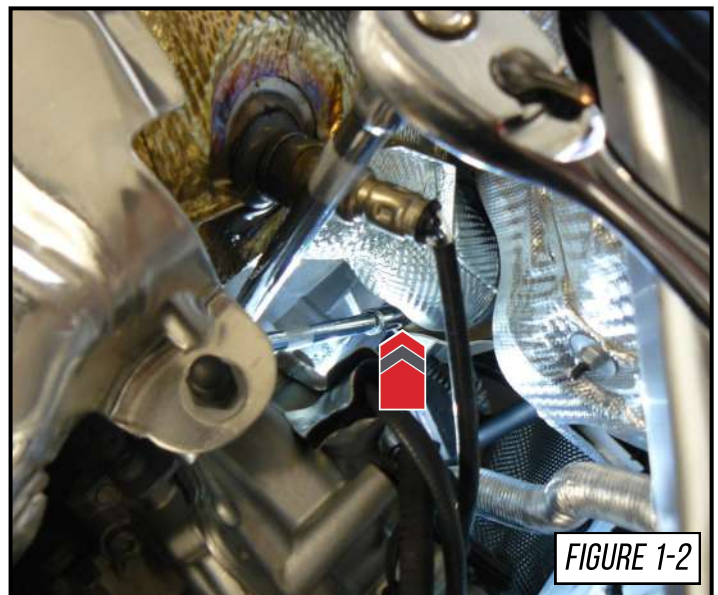

STEP 2

The remainder of the removal process takes place under the car. Removing the belly pan is accomplished by removing the fasteners as shown by the arrows in **Figure 2**.

One (1) T25 Torx, at **Arrow A**.

Two (2) quick release fasteners, at **Arrows B**.

Five (5) quarter-turn fasteners, at **Arrows C**.

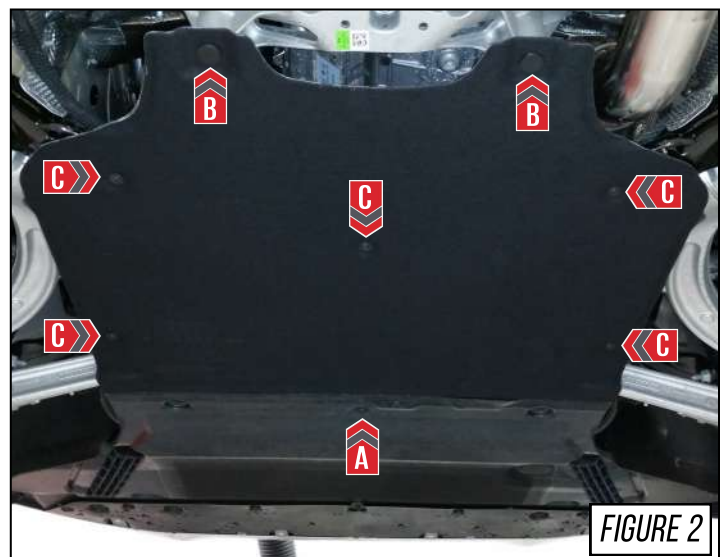

STEP 3

Next, remove the central underbody panels in order to gain access to the chassis brace bolts toward the front of the vehicle.

Each side is attached by three (3) Phillips-head screws designated by **Arrows A** and five (5) 10mm fasteners shown by **Arrows B** in **Figure 3**.

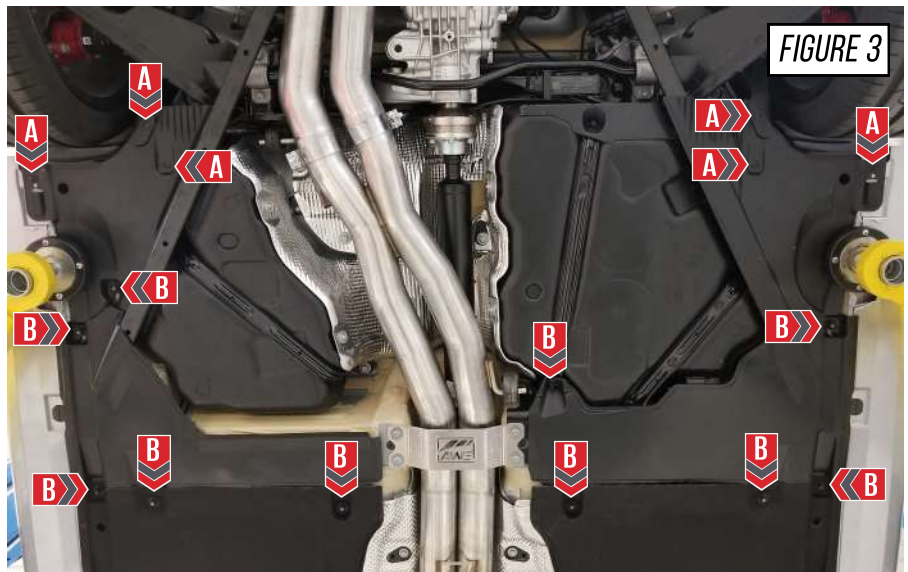

STEP 4

Uninstall the chassis braces starting with the passenger side since it is mounted below the driver side brace.

Remove the T45 bolt that joins the two braces shown by **Arrow A** in **Figure 4**.

Remove the four (4) 12mm triple-square or 16mm hex bolts shown by **Arrows B** in **Figure 4** for the passenger side and then again for the driver side.

Set the braces and hardware aside for reinstallation later point.

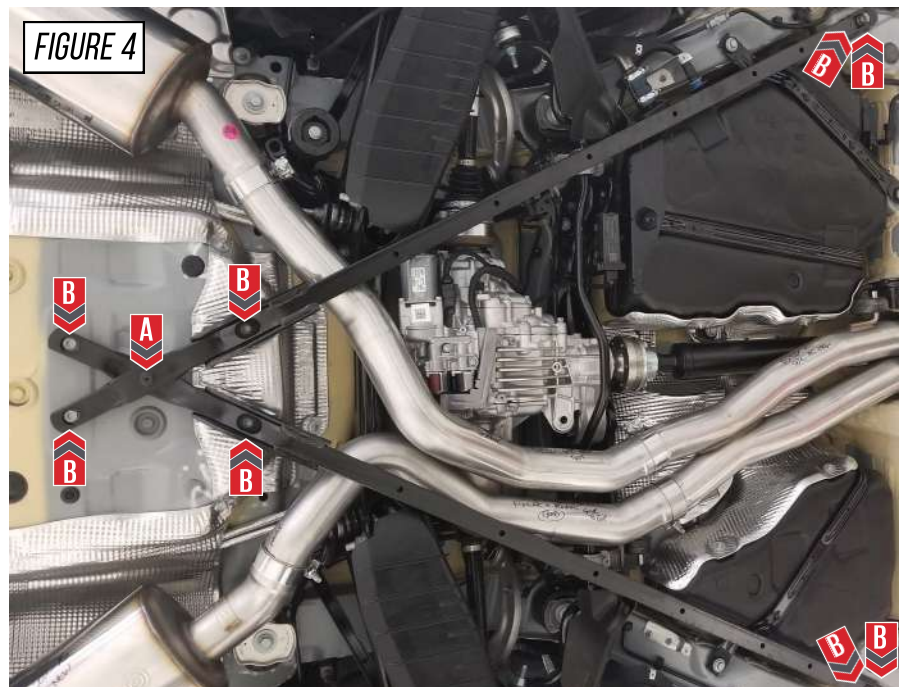

STEP 5



NOTE: Before removing any hanger supports, be sure the exhaust is supported either by a second set of hands or pole jacks.

Remove the four (4) 10mm triple square bolts that secure the cross brace in place, as shown by the arrows in **Figure 5**.

The mid-muffler hanger bracket is also held into place through these bolts; once removed, set the hanger and bracket aside for reuse on the AWE X-pipe section (*part B51*).

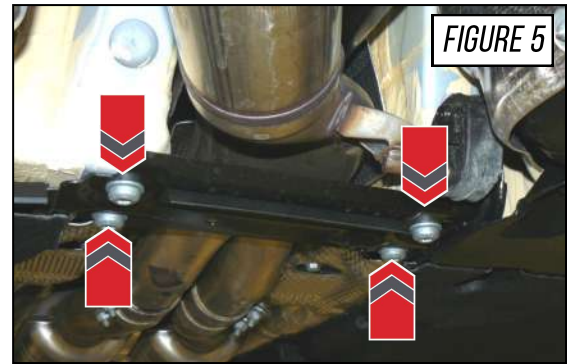

STEP 6

Unplug the valve control harness from the valve motors, located by **Arrows A** in **Figure 6-1**.

With pole jacks in place, supporting the rear sections of the OEM exhaust, remove the hanger bracket bolts located by the **Arrows B** in **Figure 6-1**.

Passenger side bolt location shown by the arrow in **Figure 6-2**.



PRO-TIP: Spray a little penetrant oil at the part of the hanger post that goes through the green hanger bushing. This will make removal and assembly go a bit smoother.

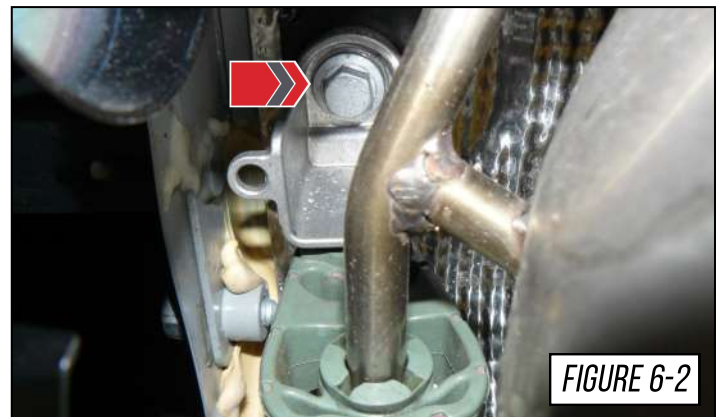
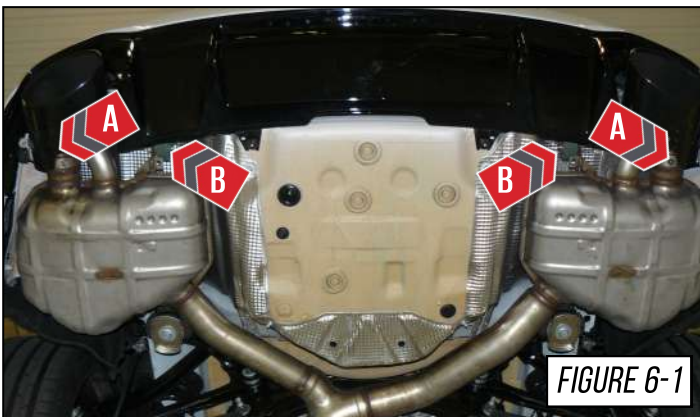

STEP 7

With the OEM rear mufflers still supported, loosen the four (4) 13mm bolts that secure the sleeve clamps into place, as shown by the arrows in **Figure 7**.

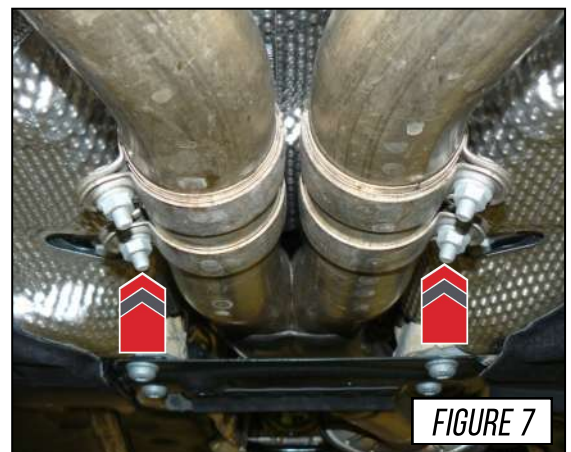

STEP 8

The hanger bushing, shown by the arrow in **Figure 8-1**, is the last part that holds the OEM rear exhaust section in place. Remove the hanger bar from the bushing, leaving the hanger assembly mounted to the vehicle.

Slide the sleeve clamps, loosened in *Step 7*, forward towards the front of the car and remove the rear section from the vehicle.

Remove the rear hanger assembly from the exhaust, location shown by the arrows in **Figure 8-2**. Reinstall the hanger assemblies into the original locations on the car.



FIGURE 8-1



FIGURE 8-2

STEP 9

Loosen and remove the two (2) last remaining 12mm nuts from the driver side exhaust flange at the catalytic converter, as shown by **Arrow A** in **Figure 9**.

Loosen and remove the 13mm bolt that secures the driver side downpipe to the support bracket, as shown by **Arrow B** in **Figure 9**.

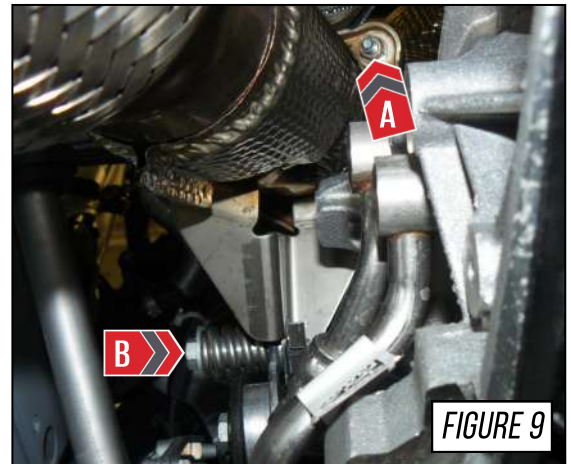

FIGURE 9

STEP 10

Next, we'll remove the passenger side downpipe which is slightly more difficult.

First, unbolt the heat shield shown by the arrow in **Figure 10**.

No need to remove this from the vehicle, but it will give you a line of sight to the bolts that will need to be loosened and removed in the next step.

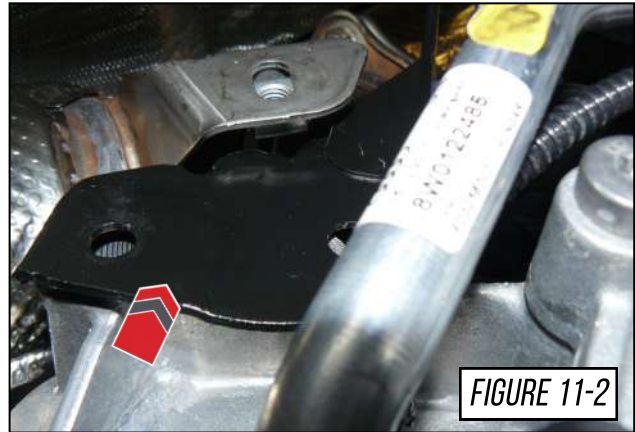
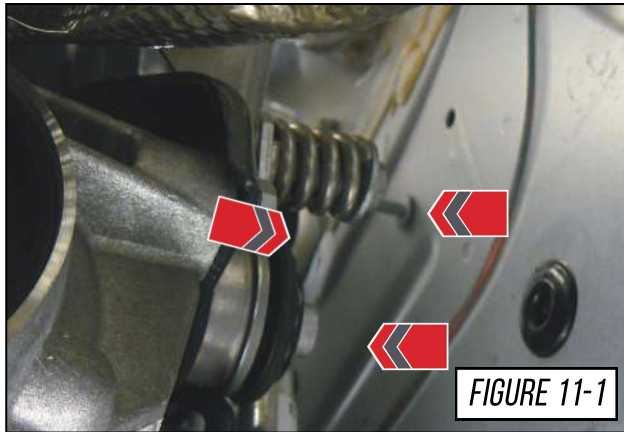

FIGURE 10

STEP 11

Locate the bracket and hardware shown by the arrows in **Figure 11-1**, and remove as shown in **Figure 11-2**.

The bracket by the arrow in **Figure 11-2** needs to be twisted up and away to gain access to the flange bolts.



STEP 12

Remove the three (3) 12mm nuts from the passenger side exhaust flange at the catalytic converter, as shown by the arrow in **Figure 12**.



PRO-TIP: Once you've gotten the nuts loose, it is possible to access a few of the nuts from the top side of the engine bay.

Again, this is the tough part—we used an extension with a universal attached to the socket and still had limited access and visibility.



STEP 13

Figure 13-1 shows the driver side removed and the downpipe support bracket twisted out of the way for the next installation step.

The arrow in **Figure 13-2** shows one nut location that can be hard to reach.

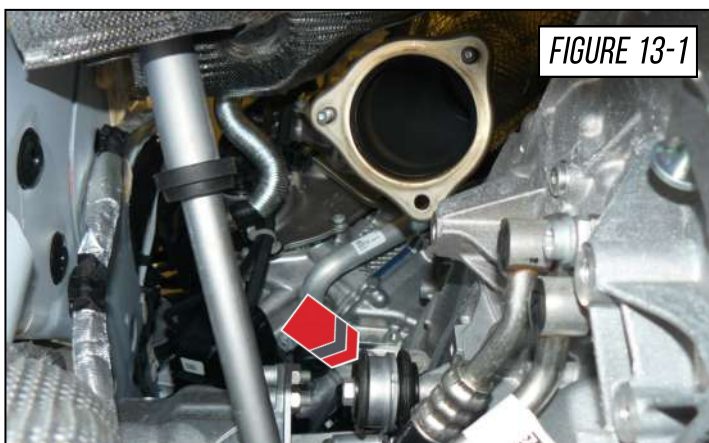

STEP 14

AWE Performance Exhaust Installation:

Install the downpipe upper sections (*part B49 & B50*) using the included flange gaskets and mounting hardware to secure them to the outlet flange of the factory catalyts.

Reinstall the mounting bracket and hanger hardware for both driver and passenger sides

Torque the exhaust flange nuts to manufacturer specification along with the spring-bolt into the support bracket. Be careful not to overtighten the spring-bolt.

The installation of either side is the reverse of the removal of the stock exhaust.

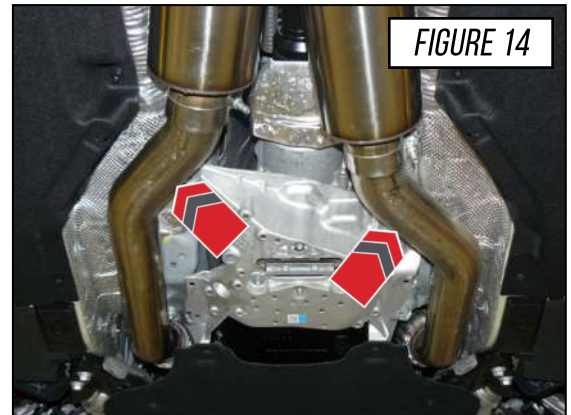

STEP 15

It is crucial to install each section and Accu-Seal clamp correctly to prevent loose joints, exhaust leaks between the tubing connections and rattles.

Arrow A in **Figure 15** shows the expanded pipe and the preinstalled Accu-Seal clamp being brought up to the corresponding pipe.

Arrow B in **Figure 15** shows the overlapping pipe installed correctly over the corresponding pipe.

Arrow C in **Figure 15** shows the Accu-Seal clamp being brought to the edge of the expanded pipe.



NOTES:

- **Do not** torque any Accu-Seal clamp until the entire exhaust has been installed and adjusted.
- Torque specification is a minimum of 60 ft/lbs

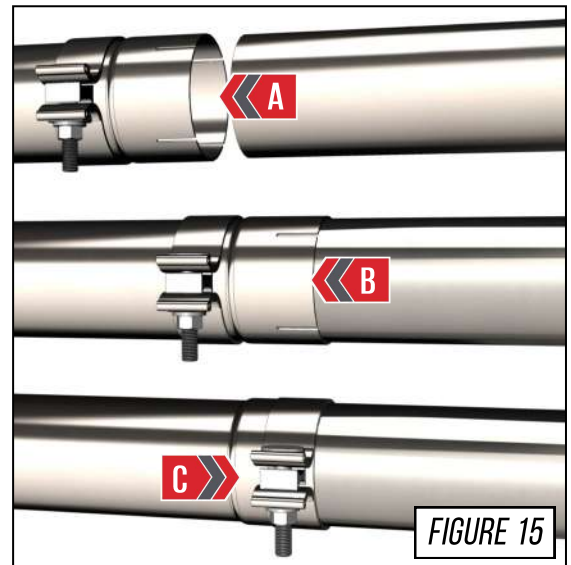

STEP 16

Install the downpipe lower sections next using two (2) of the included 3.0" Accu-Seal clamps.

For installation with the OEM catalyts, you are installing a straight tube section (*part B79 & B80*)

For the AWE performance catalyts, it is highly advised to install the resonated sections (*part B81 & B82*)

Driver side resonated section (*B81*) shown by **Arrow A** in **Figure 16**.

Passenger side resonated section (*B82*) shown by **Arrow B** in **Figure 16**.

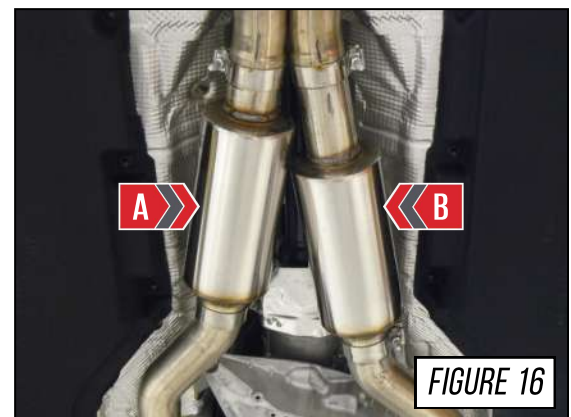

STEP 17

Transfer the OEM hanger bracket and bushing onto the correlating hanger post on the AWE X-Pipe Section, shown by **Arrow A** in **Figure 17**.

Place two (2) 3.0" Accu-Seal clamps over the inlets of the X-pipe section (*part B92*) and install into place, as shown by **Arrows B** in **Figure 17**.

Insert the AWE hanger post into the bushing that was reinstalled onto the vehicle in step 6. This is shown by **Arrow C** in **Figure 17**.

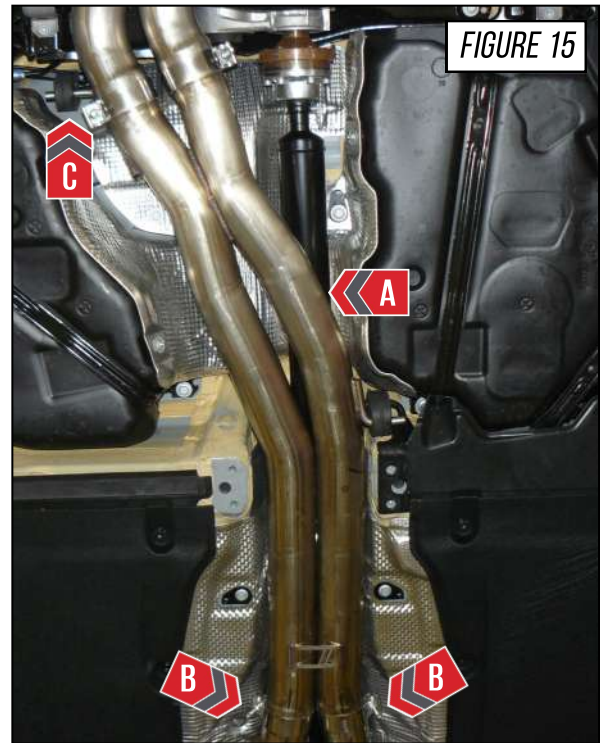

PRO-TIP: Installing both hangers before installing the cross-brace will make installation easier.

STEP 18

Place a 3.0" Accu-Seal clamp over the inlet of the Driver axle tube (*part B91*) and install onto the X-pipe section, as shown by **Arrow A** in **Figure 18-1** and **Figure 18-2**. This pipe must be installed first due to the geometry of these sections.

Place a 3.0" Accu-Seal clamp over the inlet of the passenger axle tube (*part B93*) and install onto the mid-muffler section, as shown by **Arrow B** in **Figure 18-1** and **Figure 18-2**.

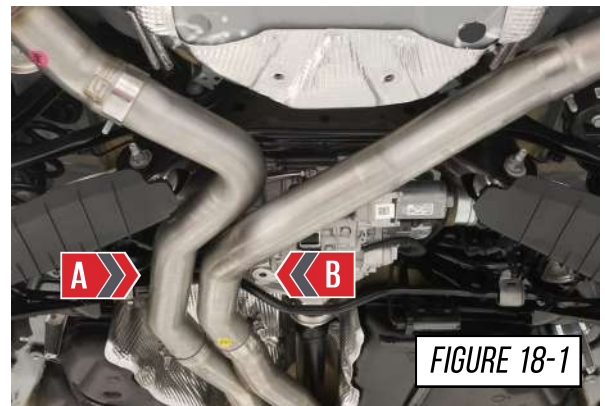

NOTE: The rear axle tubes should be fit together as shown in **Figure 18-2** with the driver side (B91) tube remaining parallel with the floor and the Passenger side (B93) tube dropping below. The tubes should not contact one another and should have plenty of space from any other parts of the vehicle.

STEP 19

Place a 3.0" Accu-Seal clamp over the inlet of the driver side rear section (**Track Edition: part B54**) or (**Touring Edition: part B75**) and install onto the outlet end of the driver axle tube, as shown by **Arrow A** in **Figure 19**.

Place a 3.0" Accu-Seal clamp over the inlet of the passenger side rear section (**Track Edition: part B55**) or (**Touring Edition: part B76**) and install connect it to the passenger axle tube, as shown by **Arrow B** in **Figure 19**.

Insert each hanger bar into the hanger bushing, as shown by **Arrows C** in **Figure 19**.

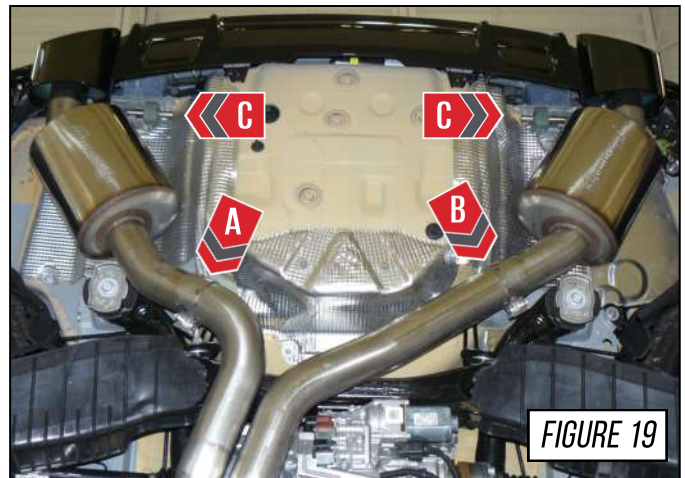

STEP 20

Installing the AWE RS Oval Tips is next; these parts have an integrated clamp that includes their own hardware. Torque specification for these is 15 ft./lbs.

Preassemble the hardware onto the integrated clamp, making sure the nut is facing the ground upon installation as shown by the arrow in **Figure 20**.

 Using a little anti seize on the threads will make tightening the tips much easier.

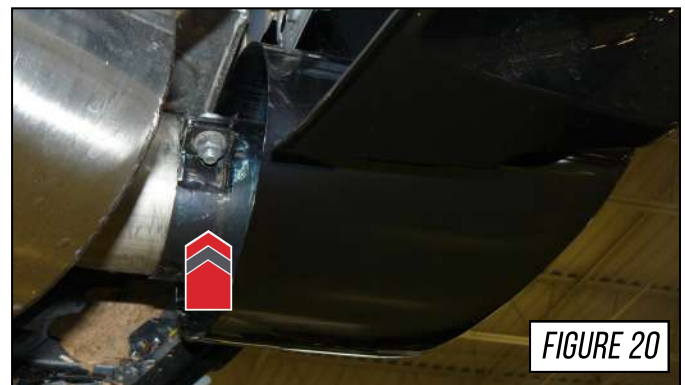

STEP 21

Install the included AWE central Chassis Brace using the hardware that came with the system.

Orientation is important here, as the bolt pattern for the bracket is unique and can only be assembled as shown by the arrow in **Figure 21**.



STEP 22

Install the remaining chassis braces starting with the driver side since the passenger side must overlap it.

For the rear mounting points, install the four (4) included chassis brace spacers as shown by **Arrows A** in **Figure 22** Along with the OEM M12 triple square bolts.

Reinstall the T45 center bolt shown by **Arrow B** in **Figure 22**

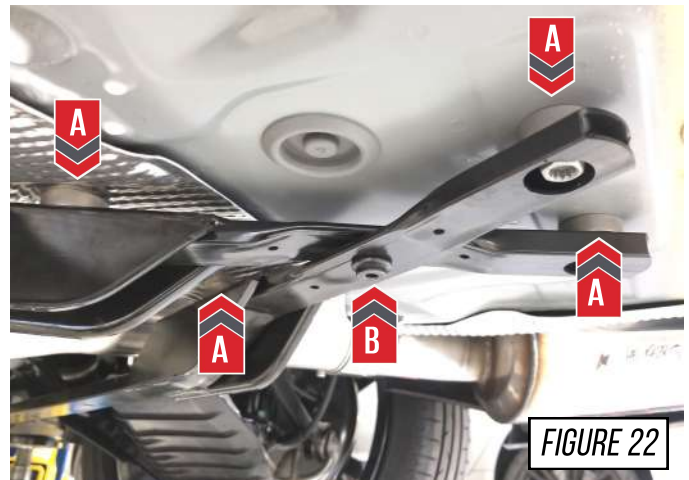

STEP 23

Reinstall the underbody brace shields and the five (5) 10mm fasteners (**Arrows A**) and three (3) T25 screws (**Arrows B**) shown in **Figure 23**

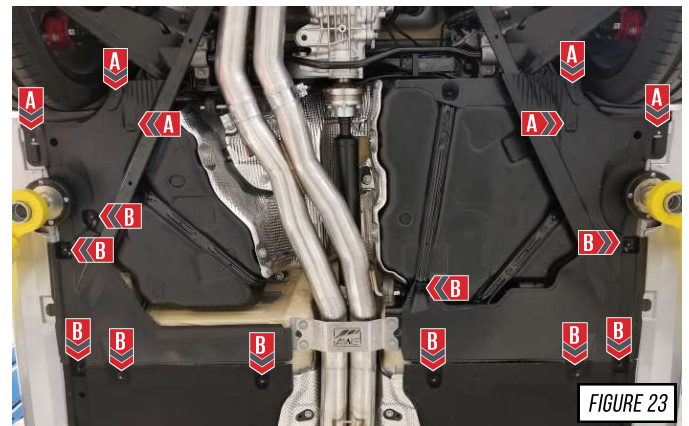

STEP 24

Replace the front under tray with the previously removed hardware:

One (1) T25 Torx, at **Arrow A**.

Two (2) quick release fasteners, at **Arrows B**.

Five (5) quarter-turn fasteners, at **Arrows C**.



STEP 25

With everything installed onto the car, you are ready to adjust the exhaust and begin the final torque procedure. Minimum torque specification for the Accu-Seal clamp is 60 ft.lbs.



PRO-TIP: The tubing moves a tiny bit as you tighten each section in progression, so keep an eye on everything and readjust as you go, if needed.

Below, **Figure 25** shows the start to finish sequence for torquing the Accu-Seal clamps.

Adjustment is critical at this point because the AWE exhaust utilizes more space than the original tube path that the manufacturer provided.

With the chassis braces installed, starting up front with the downpipes and X-pipe sections, adjust everything so there is adequate space between the factory heat shielding.

Once this part is satisfied, begin torquing the Accu-Seal clamps to the minimum torque specification stated above.

Finally, with all the Accu-Seal clamps torqued to specification, torque the integrated clamps on the RS Oval tips to a minimum of 15 ft./lbs.

The next and final step is the installation of the AWE valve simulator brackets, located on the next page.

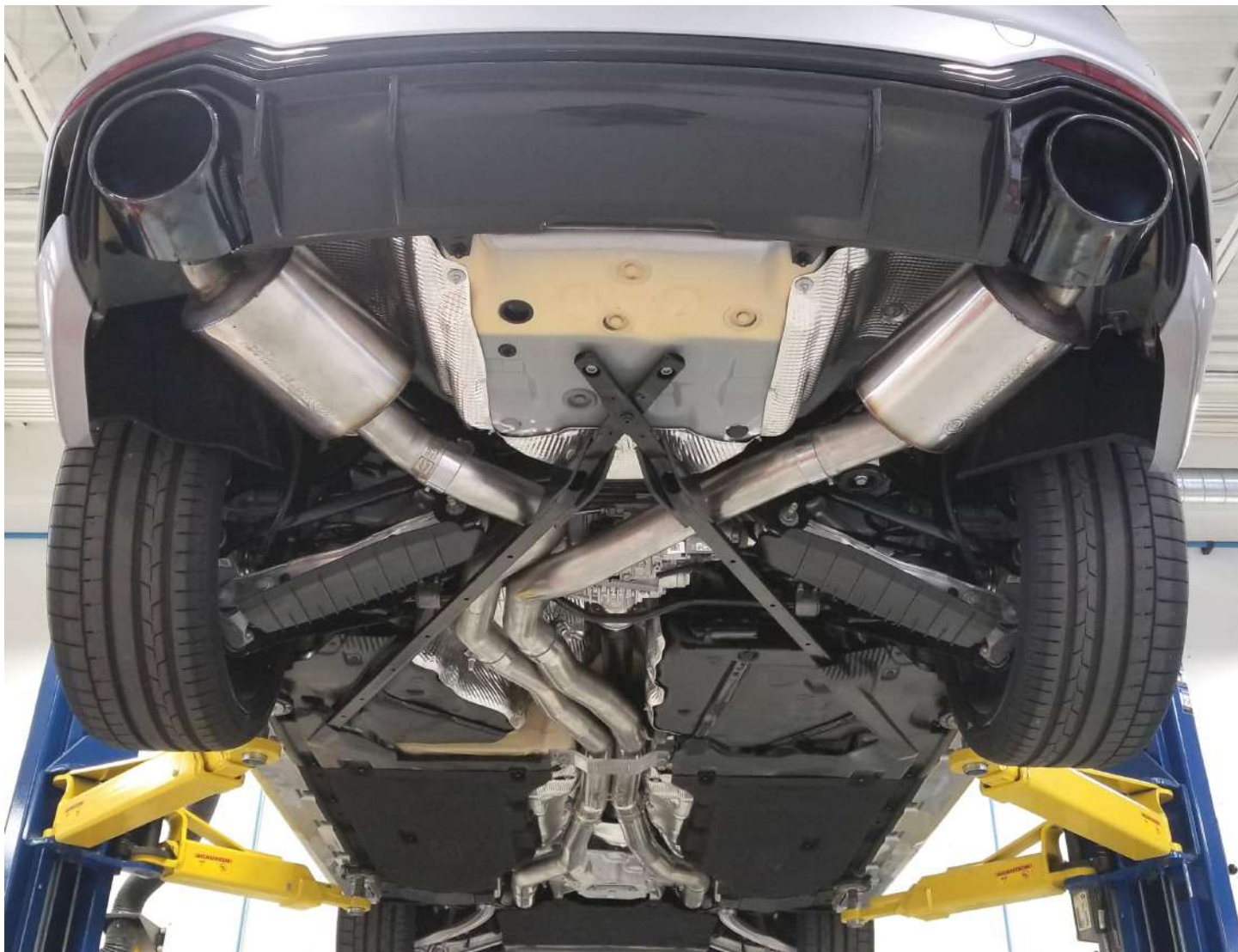

STEP 26

Valve Simulator Bracket Installation:

Remove each factory valve motor from the factory mounting location on the OE exhaust system.



NOTE: The pin shown in **Figure 26-1** is critical to the function of the valve simulator bracket. Make sure this is installed correctly.

Using the factory hardware, install the driver side valve motor onto one of the included valve motor brackets and pins, as shown in **Figure 26-1**.

Use a few cable-ties to secure the assembly up and away from the exhaust, as shown by **Arrow A** in **Figure 26-2**.

Reconnect the factory harnesses to the valve control motors, as shown by **Arrow B** in **Figure 26-2**.

Repeat the valve simulator bracket installation for the passenger side.



PRO-TIP: A properly indexed OE valve motors is critical to a smooth installation. If the valve motors have been operating while disconnected from the factory valve body, re-indexing will be required.

Installation is complete!

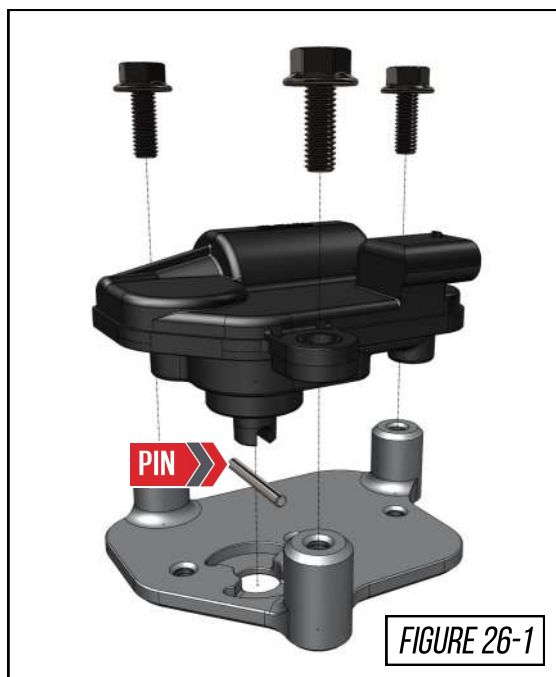

ENJOY!



TROUBLESHOOTING

Issue	Solution
Exhaust is not fitting correctly	Most fitment issues are due to improperly adjusted exhaust. This includes tip fitments and rattling due to chassis contact. Check out our fitment guide for more installation tips.
Wrong or missing parts	Double check the parts list for your system and compare them with what you received. Fill out our contact form, found below and let us know what parts you need.

CARE

Once installed properly, your AWE exhaust will provide years of trouble-free performance.

The exhaust volume and sound will settle with usage; 800-1000 miles is required to break-in new exhaust systems.

Also, please note that the rear **180Technology**® resonator has a small drain hole to allow condensation to escape. Water drops from this area are normal.

Periodic cleaning of exhaust tips is necessary to maintain proper finish, especially in areas prone to road salt and caustic deicing solutions. Use a mild soap and water solution or car wax to clean the finish. Avoid using abrasive polishes, as they can scratch the finish.



INSTALLATION GUIDE: AWE RS5 PERFORMANCE CATALYSTS

THIS PRODUCT IS INTENDED FOR THE FOLLOWING VEHICLES*:

YEAR	MAKE	MODEL	SUBMODEL	ENGINE
2018-19	Audi	RS 5	Coupe	2.9T
2019	Audi	RS 5	Sportback	2.9T

THIS GUIDE IS INTENDED FOR THE FOLLOWING PART NUMBERS:

3010-11098

Thank you for purchasing the AWE Performance Catalysts!

 **FOR RACING USE ONLY**

AWE PERFORMANCE CATALYSTS

1	B9 2.9T Performance Catalyst, DS	B73
1	B9 2.9T Performance Catalyst, PS	B74
2	B9 2.9T DP Gasket	8W0253115K
1	B9 2.9T Hardware Kit	3910-41020
	<ul style="list-style-type: none">• 6 x M8 Hex Head Cap Screw• 6 x Steel Flange Locknut	91287A154
		94920A500



IF YOU DO NOT HAVE ALL OF THE CORRECT PARTS, DO NOT CONTINUE WITH INSTALLATION.

STEP 1

First remove the factory engine cover by lifting it upwards and releasing the 4 ball pins underneath.



STEP 2

Unclip the passenger side O2 sensor harness from the heat shield.



STEP 3

Loosen the 13mm ball pin bolts that hold down the factory heat shield.



STEP 4

With the factory catalyts now accessible, label all four O2 sensors with their corresponding locations and disconnect them.

We recommend unclipping the O2 sensors at the harness to avoid twisting or breaking any of the wires.



STEP 5

Unbolt the 3 bolt flanges at the base of each converter.

This can get tricky, so make sure to try and tackle these flanges from underneath the vehicle as well if needed.



STEP 6

Next loosen up the v-band clamps at the front of the catalyst. You may need to carefully use a pry bar to break the clamp loose from the flange.

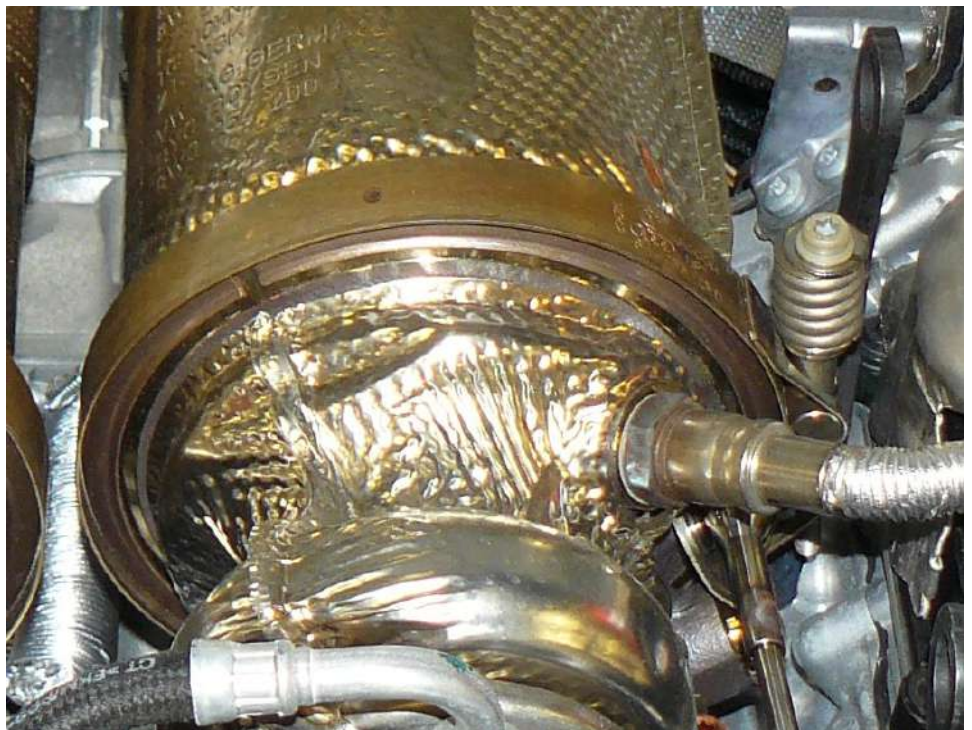

STEP 7

Once everything is loose, double check that all O2 sensors are out of the way and pull those cats.



STEP 8

The installation is the opposite of the removal of the OEM parts.

Start by lining up the flanges and re-installing the V-band clamp over them. Make sure the v-band clamp is snug enough to hold the catalyst in place but still leaves room for rotation and adjustability.

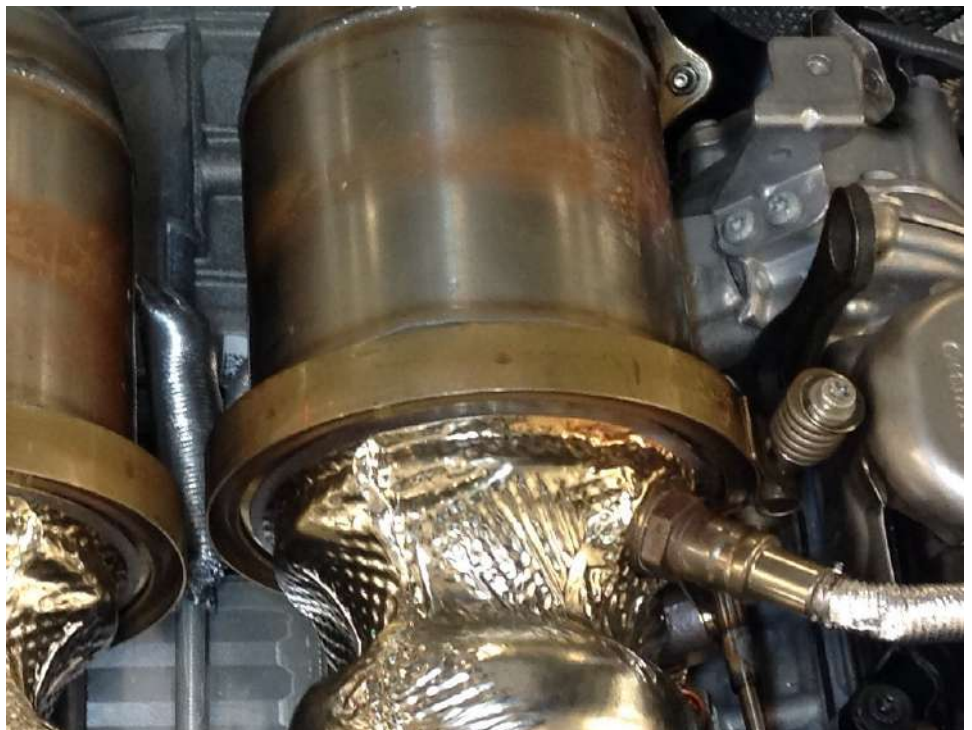

STEP 9

Next, install the three bolt flange with the supplied hardware and gaskets. Again, it may help to attack this from above and beneath the vehicle.

Once the catalyst is in place, go ahead and tighten all of the hardware applying even pressure to each.



STEP 10

Reinstall the O2 sensors making sure to return them to their original position per the labels you made previously, and you're all done!

Take a good look at your hard work and reinstall the heat shield, O2 sensor clips, and OEM engine cover.





TROUBLESHOOTING

P0420 Check Engine Light	Make sure you have no gaps or leaks in the installation. Some vehicles are particularly sensitive to variations in O2 sensor readings.
Leaks or gaps	If you see leaks or gaps, double check you installation and make sure that all joining surfaces have are mated properly and hardware is correctly tightened.