

Installation Instructions



Ventvisor® Deflector

Important Safety Information



- CAUTION - Before driving, ensure that the vent visors are properly secured to vehicle.
- Do not use automatic "brush-style" car washes.
- Do not use cleaning solvents of any kind.
- Periodically check all components for tightness.
- When using Surface Prep, avoid contact with skin. Use in well ventilated area. If contact is made with material, flush area with large amounts of water. If irritation persists, get immediate medical attention. USE PREP ON RUBBER ONLY

Contents - 2 Piece Set **NOTE:** Actual product may vary from illustration.

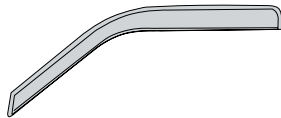

Front Driver Side Visor

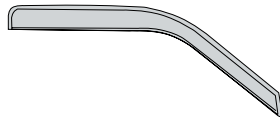

Front Passenger Side Visor



Alcohol Pad x2

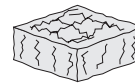

Scotch Brite Pad



Surface Prep

Contents - 4 Piece Set

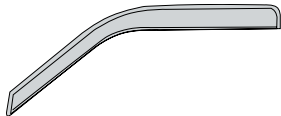

Front Driver Side Visor

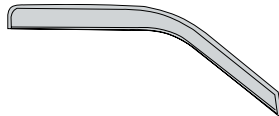

Front Passenger Side Visor



Rear Driver Side Visor



Rear Passenger Side Visor



Alcohol Pad x2



Scotch Brite Pad



Surface Prep

Tools Required



Car Wash Supplies



Clean Towel

Preparation Before Painting / Installation

- A trial fit is recommended to ensure proper positioning and fit.
- Check fit of parts before painting as we will not accept the return of modified or painted parts.
- Wash your vehicle to remove any debris and/or dirt.
- Dry with a clean towel.

Installation Steps

NOTE: Actual application may vary slightly from illustrations.



Scuff rubber trim where drivers side visor mounts with scotch brite pad. Then clean with alcohol pad. Repeat for all (4) doors.

Alcohol Pad

mirror cap

1

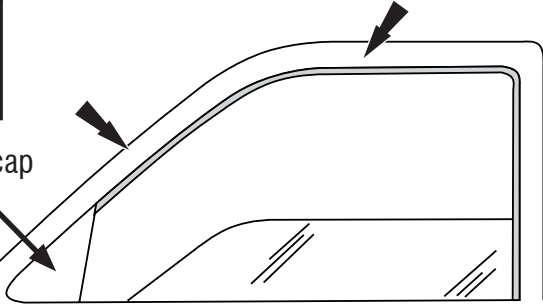

Apply one coat of surface prep to previously cleaned rubber trim on all (4) doors promptly to prevent evaporation.

2

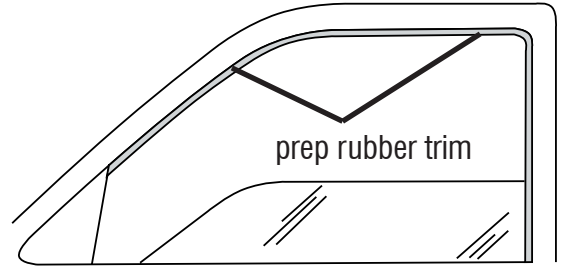

Peel back 2" (5cm) of tape liner from the front and rear flanges.

tape liner

rear end flange

tape liner

front end flange

3

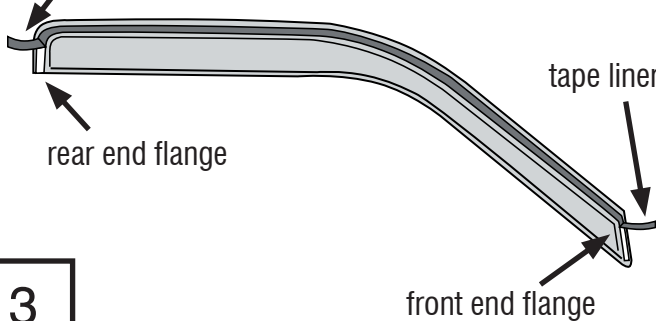

Align the drivers side visor with previously cleaned rubber trim. Slide the front end flange under the mirror cap. Press exposed area of tape.

free end

slide under mirror cap

free end

4

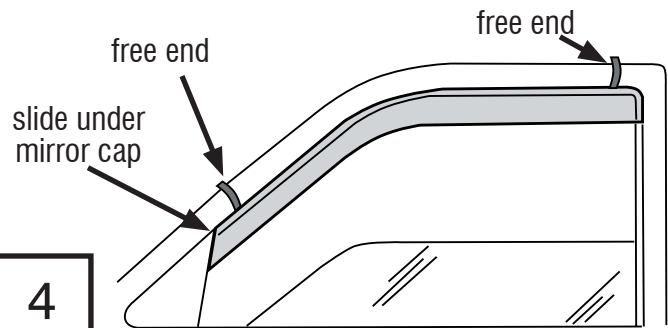

With the visor in its final position, remove the remainder of the tape liner by pulling on free ends.

5

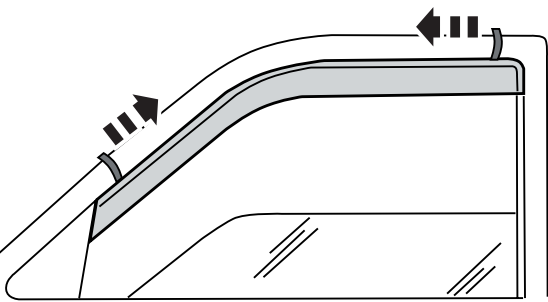

Apply pressure along flange edges to ensure proper adhesion.



6

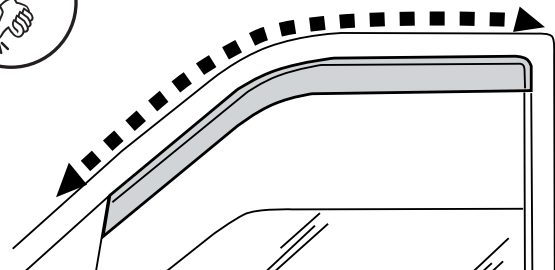

The drivers side rear visor attaches to the rubber trim utilizing the same procedure.

rear visor in final position

7

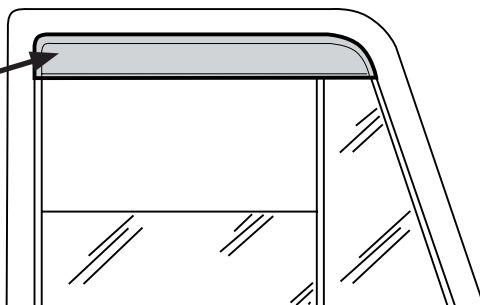

Repeat **Steps 1-7** for passenger side.

Care and Cleaning

- Wash only with mild soap & dry with a clean cloth.

Congratulations!

You have purchased one of the many quality Auto Ventshade™ branded products offered by Lund International, Inc. We take the utmost pride in our products and want you to enjoy years of satisfaction from your investment. We have made every effort to ensure that your product is top quality in terms of fit, durability, finish and ease of installation.

