

Installation Instructions



AUTO VENT SHADE™

Ventvisor® Deflector

Important Safety Information



- CAUTION - Before driving, ensure that the vent visor is properly secured to vehicle.
- Do not use automatic "brush-style" car washes.
- Do not use cleaning solvents of any kind.
- Periodically check all components for tightness.

Contents - 2 Piece Set **NOTE:** Actual product may vary from illustration.

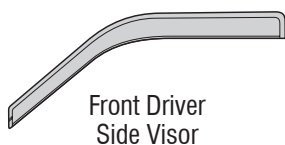

Front Driver Side Visor

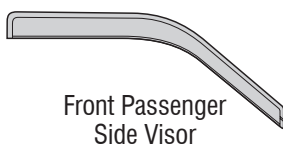

Front Passenger Side Visor



Alcohol Pad x2

Contents - 4 Piece Set



Front Driver Side Visor



Front Passenger Side Visor

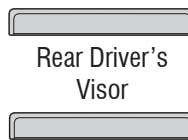

Rear Driver's Visor



Rear Passenger's Visor



Alcohol Pad x4

Tools Required



Car Wash Supplies



Clean Towel

Preparation Before Painting / Installation

- A trial fit is recommended to ensure proper positioning and fit.
- Check fit of parts before painting as we will not accept the return of modified or painted parts.
- Wash and dry your vehicle to remove any debris and/or dirt from the installation area.

Installation Steps **NOTE:** Actual application may vary slightly from illustrations.



Clean the window frame that runs along the top of the door with an alcohol pad, and wipe dry with a soft cloth.

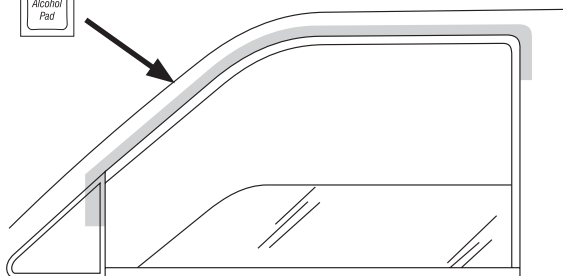

1

Remove tape liner from front and rear flanges of visor. Peel back 2" (5 cm) of tape liner from each end of the lateral flange.

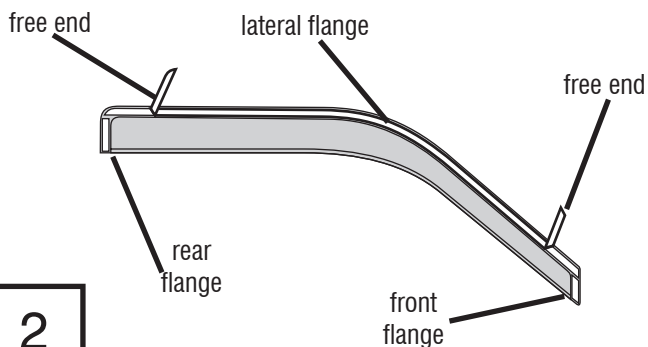

2

Installation Steps

NOTE: Actual application may vary slightly from illustrations.

Align visor to the previously cleaned surface. The visor attaches to the surface of the door above the trim.

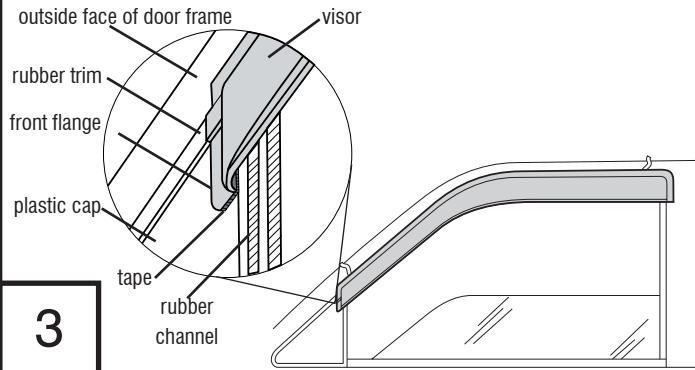

Gently press the exposed areas of tape against the surface and verify position. With the visor in its final position, remove the remaining tape liner by pulling on free ends.

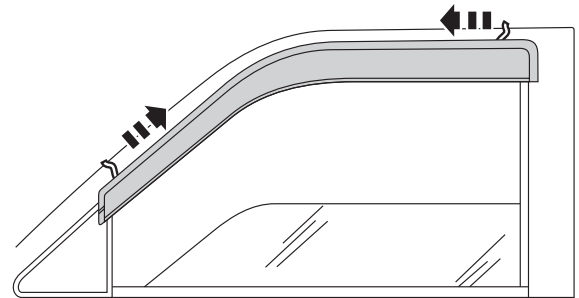

Apply pressure along all flanges to ensure proper adhesion of tape.

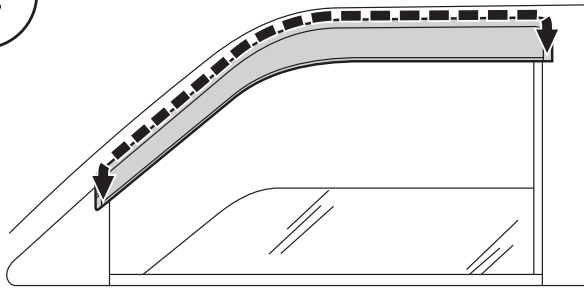

4 Piece Set

The rear visor attaches with the same preparation methods as the front visor.

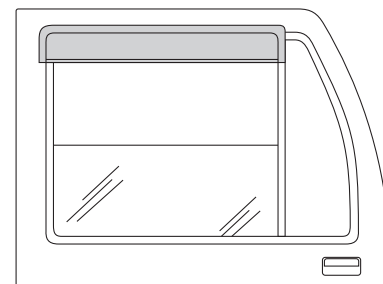

Repeat **Steps 1-6** for opposite side.

Care and Cleaning

- Wash only with mild soap & dry with a clean cloth.

Congratulations!

You have purchased one of the many quality Auto Ventshade™ branded products offered by Lund International, Inc. We take the utmost pride in our products and want you to enjoy years of satisfaction from your investment. We have made every effort to ensure that your product is top quality in terms of fit, durability, finish and ease of installation.

