

Installation Instructions



Ventvisor® Deflector

Important Safety Information



- CAUTION - Before driving, ensure that the vent visors are properly secured to vehicle.
- Do not use automatic "brush-style" car washes.
- Do not use cleaning solvents of any kind.
- Periodically check all components for tightness.
- When using Surface Prep, avoid contact with skin. Use in well ventilated area. If contact is made with material, flush area with large amounts of water. If irritation persists, get immediate medical attention. USE PREP ON RUBBER ONLY

Contents - 2 Piece Set **NOTE:** Actual product may vary from illustration.

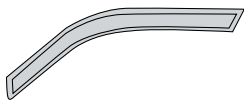

Front Driver Side Visor

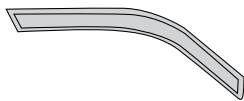

Front Passenger Side Visor



Alcohol Pad x2

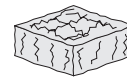

Scotch Brite Pad

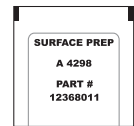

Surface Prep Pad x1

Contents - 4 Piece Set

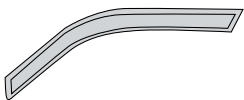

Front Driver Side Visor

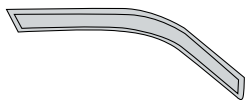

Front Passenger Side Visor

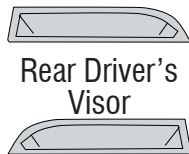

Rear Driver's Visor

Rear Passenger's Visor



Alcohol Pad x4

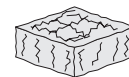

Scotch Brite Pad

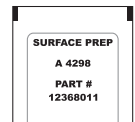

Surface Prep Pad x1

Tools Required



Car Wash Supplies

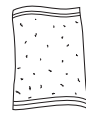

Clean Towel



Safety Gloves

Preparation Before Painting / Installation

- Please review your warranty card **BEFORE** installation of this product.
- A trial fit is recommended to ensure proper positioning and fit.
- Check fit of parts before painting as we will not accept the return of modified or painted parts.
- Wash and dry your vehicle to remove any debris and/or dirt from the installation area.

Installation Steps

NOTE: Actual application may vary slightly from illustrations.

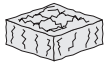

Buff the vinyl rubber window channel with a scotch brite pad, and clean with an alcohol pad. Wipe dry with a soft cloth. Apply one coat of surface prep to rubber trim. **NOTE:** Prep rubber trim on both sides before installing the visors to prevent towelette from drying.

SURFACE PREP
A-4208
PART #
12368011

Alcohol
Pad

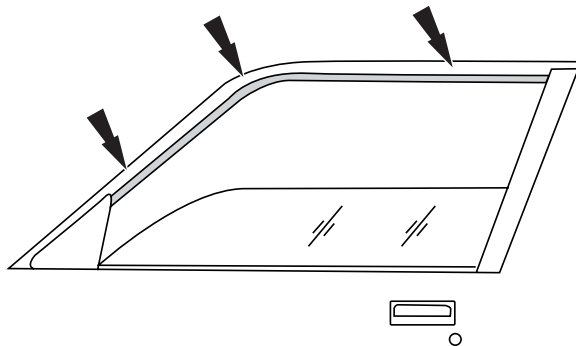

1

Remove tape liner from rear flange of visor. Peel back 2" (5 cm) of tape liner from each end of the lateral flange.

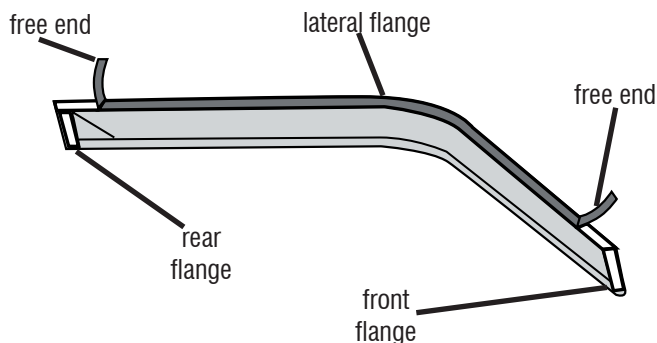

2

Align the visor on the vehicle door. The lateral flange will apply below the metal trim onto the vinyl window channel. The front end flange will attach on top of the mirror base plate.

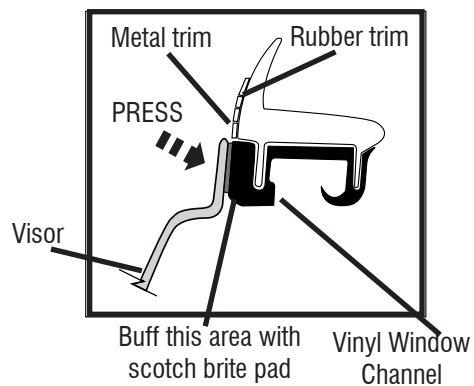
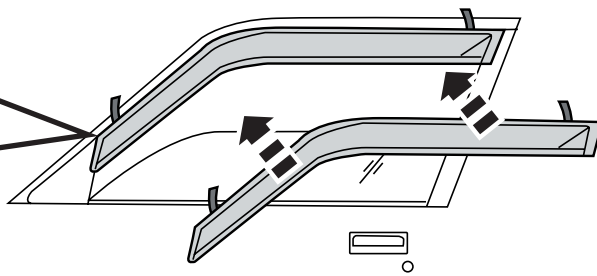
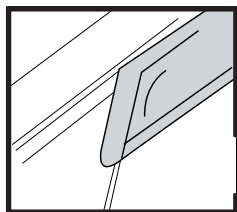

3

Gently press the exposed areas of tape against the surface and verify position.

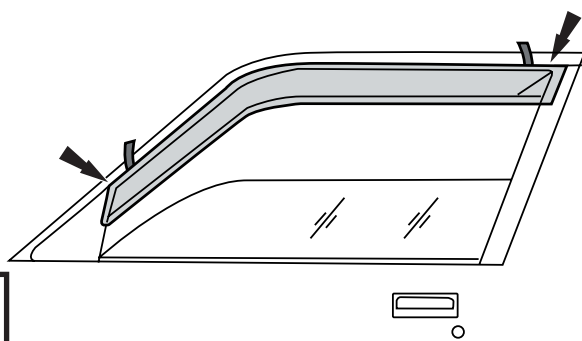

4

With the visor in its final position, remove the remaining tape liner by pulling on free ends.

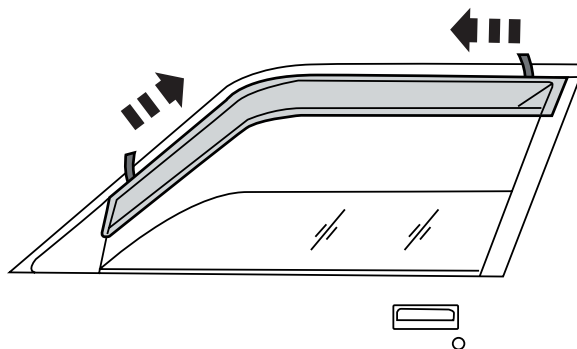

5

Installation Steps

NOTE: Actual application may vary slightly from illustrations.

Apply pressure along all flanges to ensure proper adhesion of tape.

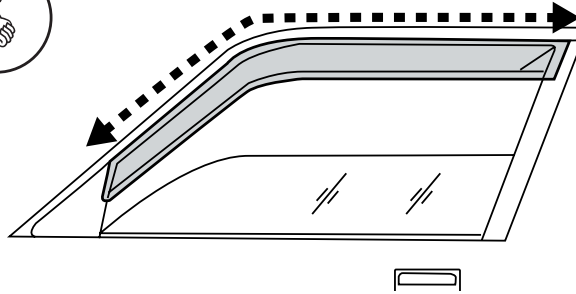

6

4 Piece Set

Clean the painted metal door frame with an alcohol pad and wipe dry with a soft cloth.

Alcohol Pad

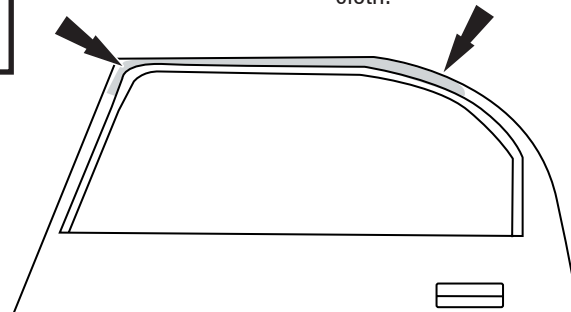

7

Remove 2" (5 cm) of tape liner from each end of visor, and align the visor to the prepared surface. Remove remaining tape liner and apply pressure.

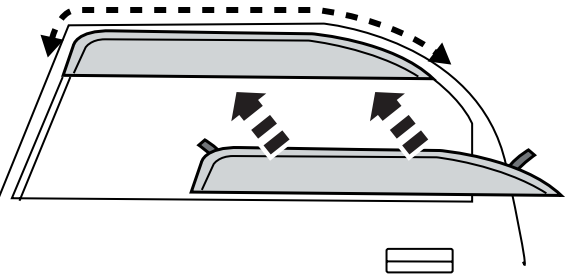

8

Repeat **Steps 1-8** for opposite side.

Care and Cleaning

- Wash only with mild soap & dry with a clean cloth.

Congratulations!

You have purchased one of the many quality Auto Ventshade™ branded products offered by Lund International, Inc. We take the utmost pride in our products and want you to enjoy years of satisfaction from your investment. We have made every effort to ensure that your product is top quality in terms of fit, durability, finish and ease of installation.

