

Installation Instructions



AUTO VENTSHADE™

Ventvisor® Deflector

Important Safety Information



- CAUTION - Before driving, ensure that the vent visor is properly secured to vehicle.
- Do not use automatic "brush-style" car washes.
- Do not use cleaning solvents of any kind.
- Periodically check all components for tightness.

Contents - 2 Piece Set **NOTE:** Actual product may vary from illustration.



Front Driver Side Visor



Front Passenger Side Visor



Alcohol Pad x2

Contents - 4 Piece Set



Front Driver Side Visor



Front Passenger Side Visor



Rear Driver Side Visor



Rear Passenger Side Visor



Alcohol Pad x4

Tools Required



Car Wash Supplies



Clean Towel

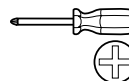

Screwdriver

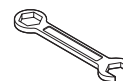

Wrench

Preparation Before Painting / Installation

- A trial fit is recommended to ensure proper positioning and fit.
- Check fit of parts before painting as we will not accept the return of modified or painted parts.
- Wash and dry your vehicle to remove any debris and/or dirt from the installation area.

Installation Steps **NOTE:** Actual application may vary slightly from illustrations.

Open door and lower window.

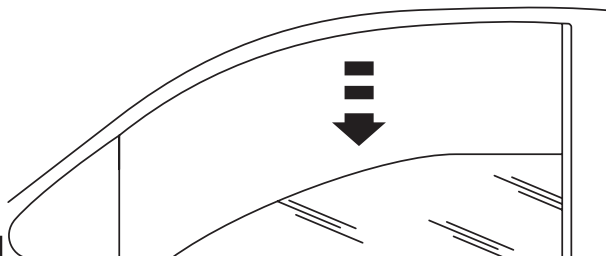

1



2

Locate fasteners that attach side mirror to door. Loosen (but do not remove) the fasteners to create the necessary gap behind mirror cap to install front visor flange.

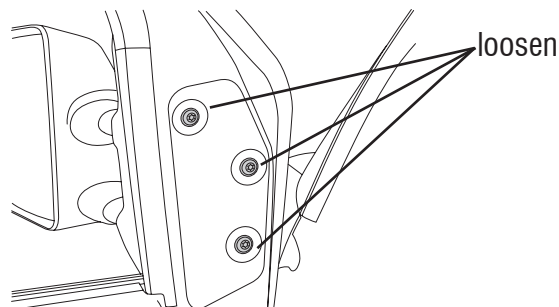

Installation Steps

NOTE: Actual application may vary slightly from illustrations.

Alcohol Pad

Clean the painted metal door frame around the front window with an alcohol pad.

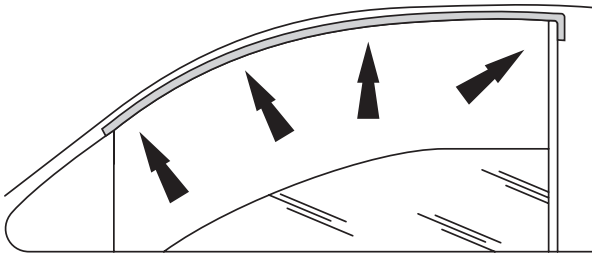

3

Remove tape liner from front & rear flange. Peel back 2" (5 cm) of tape line from each end of top flange.

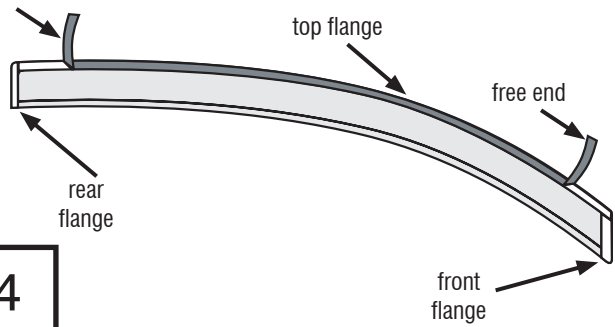

4

Align the visor on the metal door frame.

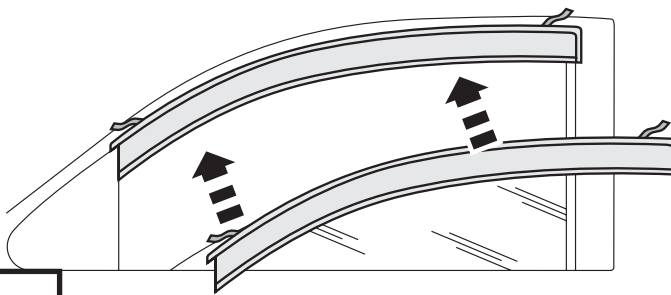

5

Position the front visor flange in the gap under the mirror cap created in Step 2.

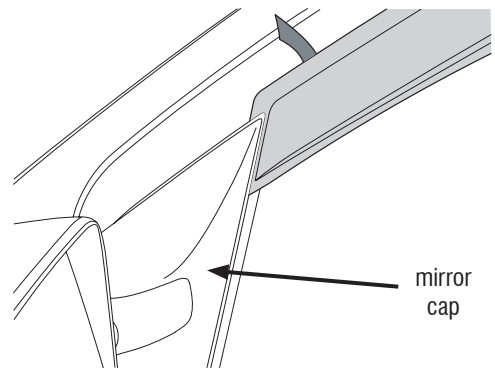

6

Gently press along exposed area of tape to secure in place.

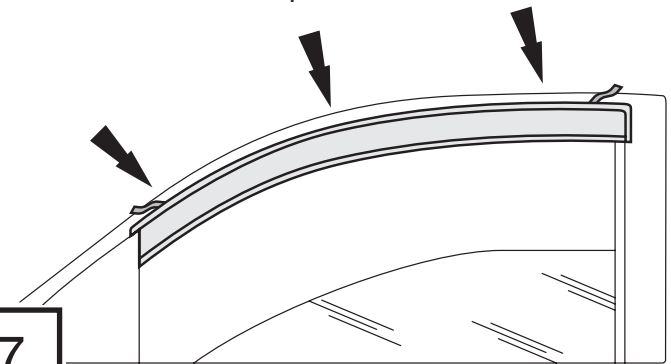

7

With the visor in its final position, remove remaining tape liner by pulling on free ends.

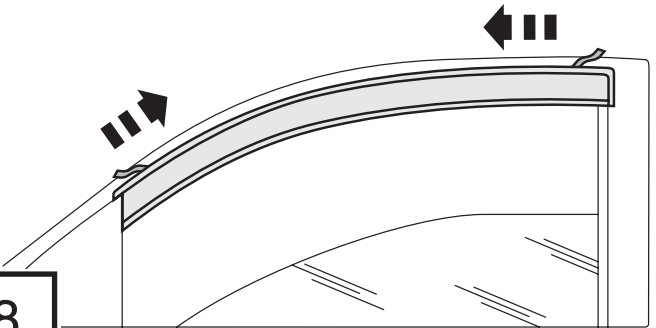

8

Press firmly along tape flanges to ensure tape adhesion.

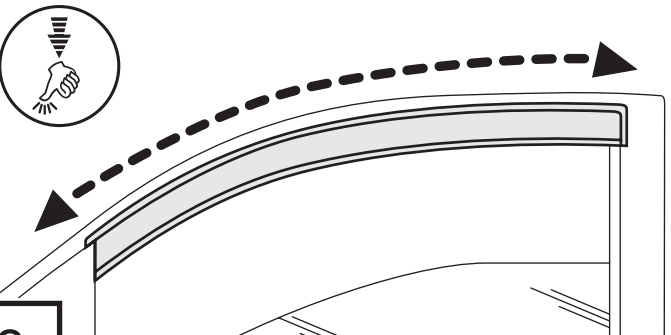

9

Re-tighten mirror mounting fasteners. To avoid damaging the mirror, do not overtighten the mirror mounting bolts.

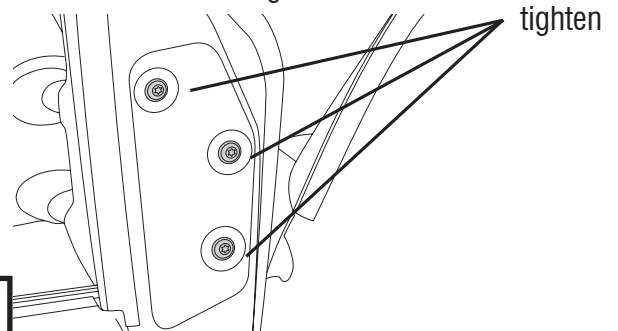

10

Installation Steps

NOTE: Actual application may vary slightly from illustrations.

Repeat **Steps 1 - 10** for passenger side front visor

4 Piece Set

Clean the painted metal door frame around the rear window with an alcohol pad.

Alcohol Pad

11

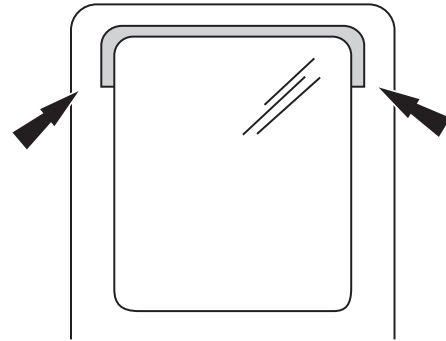

Remove tape liner from front & rear flange. Peel back 2" (5 cm) of tape line from each end of top flange.

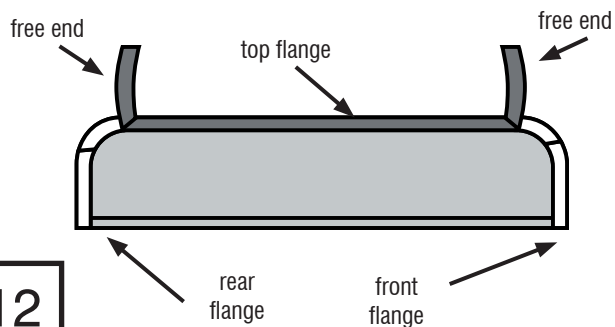

12

Align the visor on the metal door frame, remove remaining tape liners, and apply pressure to secure in place.

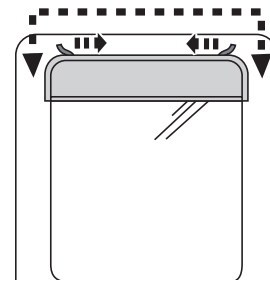

13

Repeat **Steps 11 - 13** for passenger side rear visor

Care and Cleaning

- Wash only with mild soap & dry with a clean cloth.

Congratulations!

You have purchased one of the many quality Auto Ventshade™ branded products offered by Lund International, Inc. We take the utmost pride in our products and want you to enjoy years of satisfaction from your investment. We have made every effort to ensure that your product is top quality in terms of fit, durability, finish and ease of installation.

