

Installation Instructions

Ventvisor® Deflector

Important Safety Information



- CAUTION - Before driving, ensure that the vent visor is properly secured to vehicle.
- Do not use automatic "brush-style" car washes.
- Do not use cleaning solvents of any kind.
- Periodically check all components for tightness.

Contents - 2 Piece Set **NOTE:** Actual product may vary from illustration.



Front Driver
Side Visor



Front Passenger
Side Visor



Alcohol Pad x2

Contents - 4 Piece Set



Front Driver
Side Visor



Front Passenger
Side Visor



Rear Driver
Side Visor



Rear Passenger
Side Visor



Alcohol Pad x4

Tools Required



Car Wash Supplies

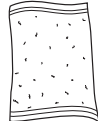

Clean Towel

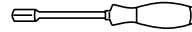

Nut Driver

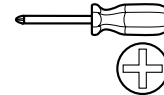

Phillips Screwdriver

Preparation Before Painting / Installation

- A trial fit is recommended to ensure proper positioning and fit.
- Check fit of parts before painting as we will not accept the return of modified or painted parts.
- Wash and dry your vehicle to remove any debris and/or dirt from the installation area.

Installation Steps **NOTE:** Actual application may vary slightly from illustrations.



Alcohol Pad

Clean the metal door frame around the window with an alcohol pad.

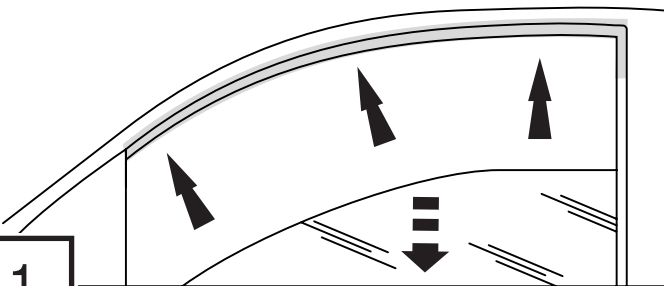

1

Remove tape liner from rear flange. Peel back 2" (5 cm) of tape line from each end of top flange.

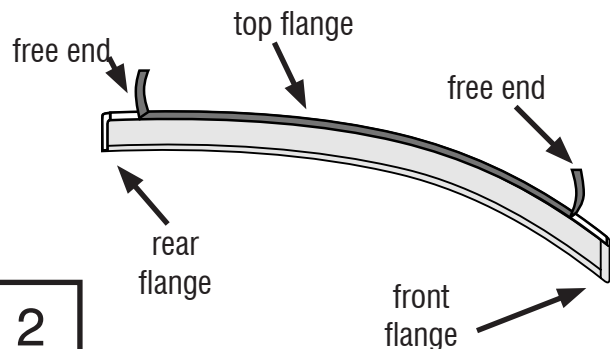

2

Installation Steps

NOTE: Actual application may vary slightly from illustrations.

Remove the triangular plastic mirror cap cover on the inside door panel.

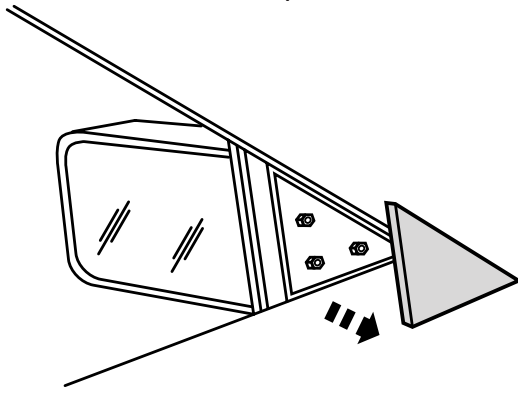

3

Using the appropriate tool, loosen but do not remove the mirror mounting bolts to create a gap behind the mirror cap in order to install the front flange of the deflector.

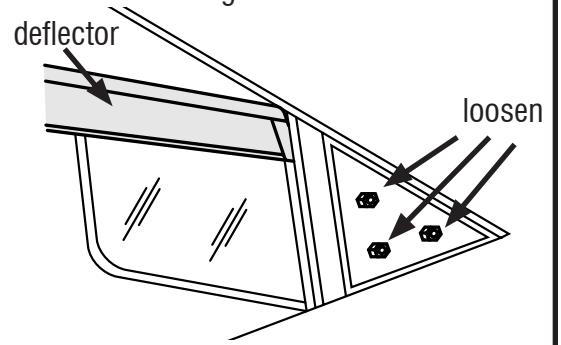
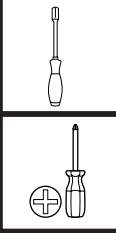

4

Position the deflector on the metal door frame and gently press exposed tape to secure in place.

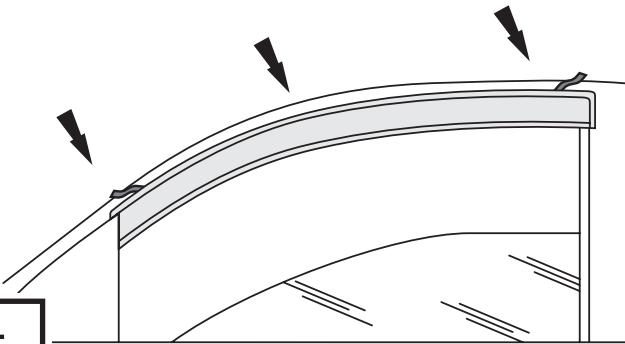

5

With the deflector in its final position, remove remaining tape liner by pulling on free ends.

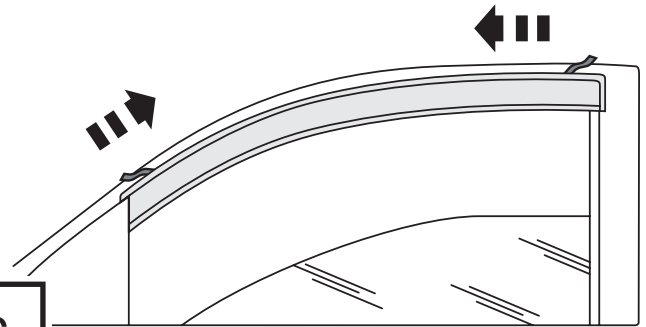

6

Apply pressure along the flange edges to secure in place.

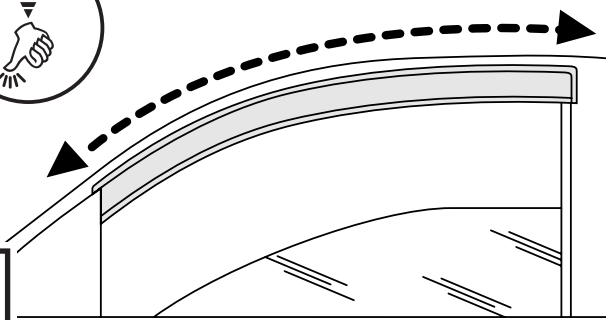

7

Retighten mirror mounting bolts and replace the plastic mirror cap on the inside of door.

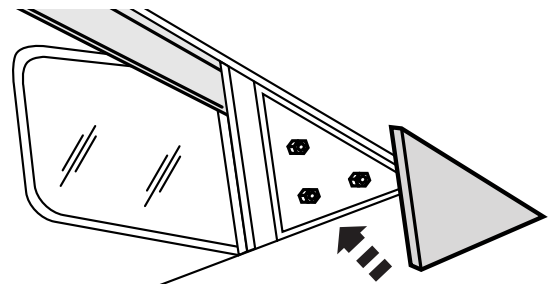
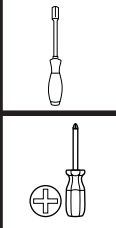

8

To avoid damaging the deflector, **do not over-tighten the mirror mounting bolts.**

Repeat **Steps 1 - 8** for the passenger side front deflector.

Installation Steps

NOTE: Actual application may vary slightly from illustrations.

4 Piece Set

After cleaning with an alcohol pad and peeling back tape liner, repeat **Steps 5 - 7** for the rear deflectors.

Alcohol Pad

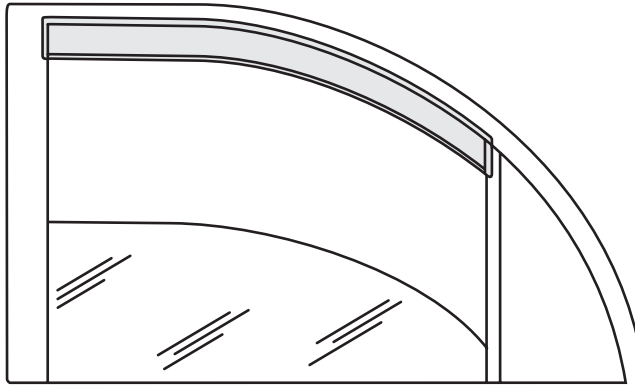

9

Care and Cleaning

- Wash only with mild soap & dry with a clean cloth.

Congratulations!

You have purchased one of the many quality Auto Ventshade™ branded products offered by Lund International, Inc. We take the utmost pride in our products and want you to enjoy years of satisfaction from your investment. We have made every effort to ensure that your product is top quality in terms of fit, durability, finish and ease of installation.

