

Installation Instructions



Ventvisor® Deflector

Important Safety Information



- CAUTION - Before driving, insure that the vent visor is properly secured to vehicle.
- Do not use automatic “brush-style” car washes.
- Do not use cleaning solvents of any kind.
- Periodically check all components to make sure they are secure.

Contents - 2 Piece Set

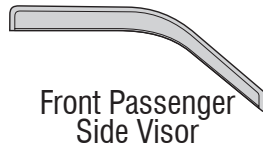

Alcohol Pad x2



Scotch Brite Pad

Contents - 4 Piece Set

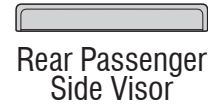

Alcohol Pad x4



Scotch Brite Pad

Tools Required



Car Wash Supplies



Clean Towel

Preparation Before Painting / Installation

- A trial fit is recommended to ensure proper positioning and fit.
- Check fit of parts before painting as we will not accept the return of modified or painted parts.
- Wash your vehicle to remove any debris and/or dirt from installation area.
- Dry the installation area with a clean towel.

Installation Steps

NOTE: Actual application may vary slightly from illustrations.



Scuff rubber trim with Scotch Brite scuff pad. Clean trim/mirror cap with alcohol pad.

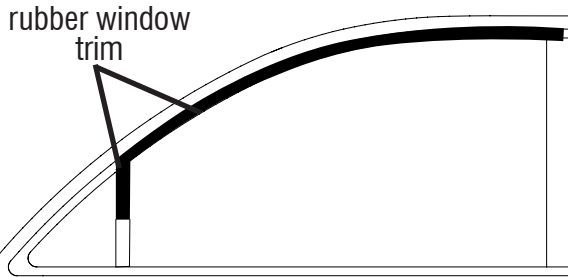

1

Peel back tape liner 2" on front and rear end flanges.

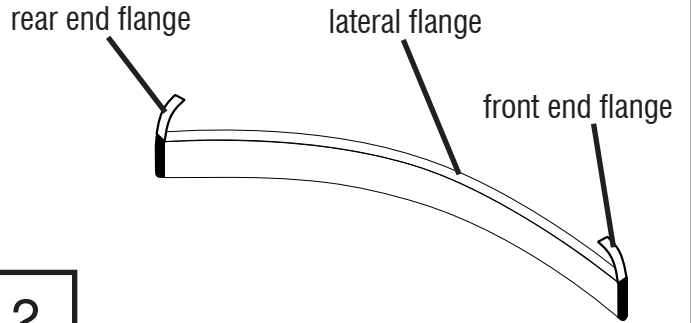

2

Align driver side vent visor with previously cleaned area and apply pressure to exposed tape

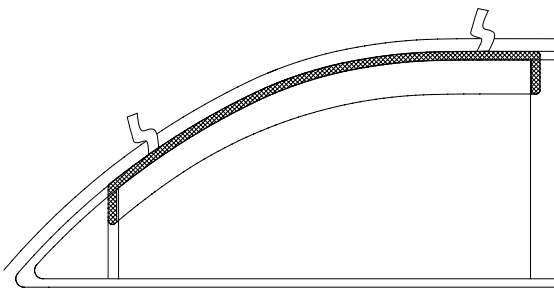

3

Remove remaining tape liner.

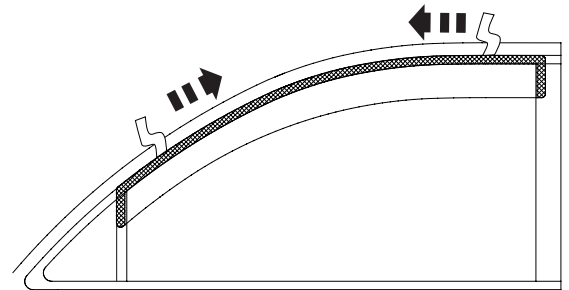

4

Apply pressure along length of vent visor to secure.

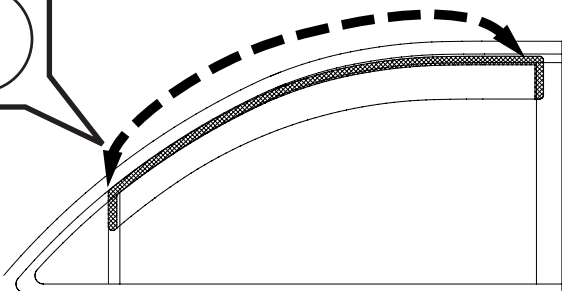

5

Repeat installation procedure for passenger side front vent visor.

Installation Steps

NOTE: Actual application may vary slightly from illustrations.

4 piece Set



Alcohol Pad

Scuff rubber trim with Scotch Brite scuff pad. Clean trim along top of door with alcohol pad.

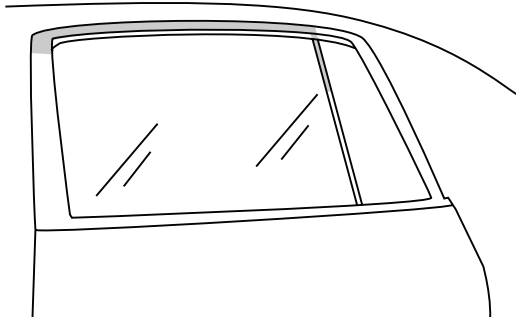

6

Remove tape liner from front and rear flanges. Peel back 2" of tape liner from each end.



7

Align vent visor with previously cleaned area and apply pressure to exposed tape. Remove remaining tape liner.

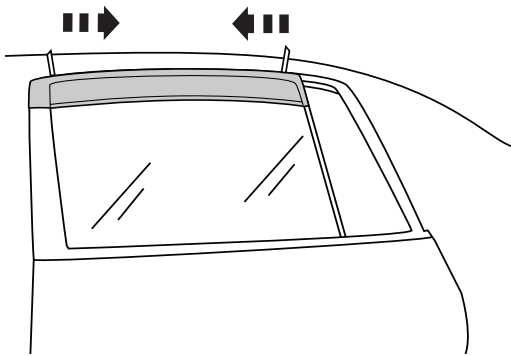

8

Apply pressure along length of vent visor to secure.

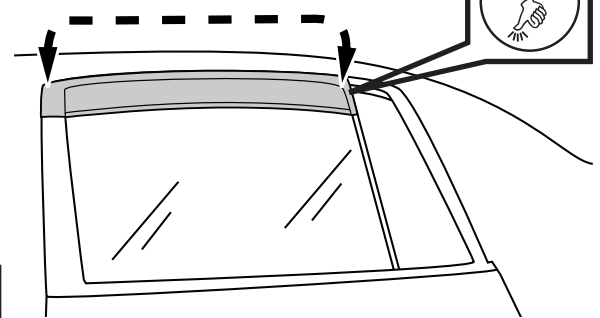

9

Repeat installation procedure for passenger side rear vent visor.

Care and Cleaning

- Wash only with mild soap & dry with a clean cloth.

Congratulations!

You have purchased one of the many quality Auto Ventshade™ branded products offered by Lund International, Inc. We take the utmost pride in our products and want you to enjoy years of satisfaction from your investment. We have made every effort to ensure that your product is top quality in terms of fit, durability, finish and ease of installation.

