

Installation Instructions



AUTO VENT SHADE™

Ventvisor® Deflector

Important Safety Information



- CAUTION - Before driving, ensure that the vent visors are properly secured to vehicle.
- Do not use automatic “brush-style” car washes.
- Do not use cleaning solvents of any kind.
- Periodically check all components for tightness.

Contents - 2 Piece Set **NOTE:** Actual product may vary from illustration.

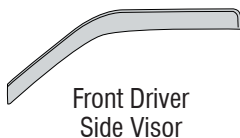

Front Driver Side Visor

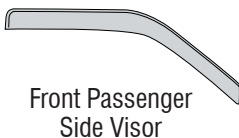

Front Passenger Side Visor



Scotch Brite Pad



Alcohol Pad x2

Contents - 4 Piece Set

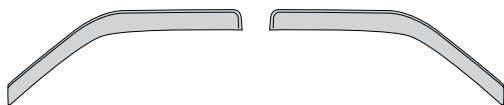

Front Driver Side Visor

Front Passenger Side Visor



Rear Driver Side Visor



Rear Passenger Side Visor

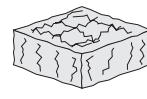

Scotch Brite Pad



Alcohol Pad x4

Tools Required



Car Wash Supplies



Clean Towel

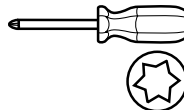

Star head screwdriver

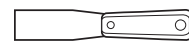

Putty Knife

Preparation Before Painting / Installation

- A trial fit is recommended to ensure proper positioning and fit.
- Check fit of parts before painting as we will not accept the return of modified or painted parts.
- Wash and dry your vehicle to remove any debris and/or dirt from the installation area.

Installation Steps **NOTE:** Actual application may vary slightly from illustrations.



Scuff the rubber trim where the visor will mount with the scotch brite pad, then clean with an alcohol pad.

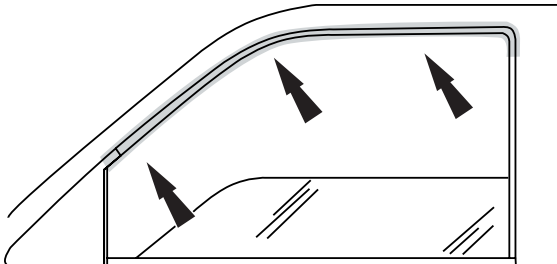

1

NOTE: Visors mount on the **OUTSIDE** trim of the door frame, except extended cab.



To facilitate front end flange positioning it may be necessary to loosen the (3) star screws located on the mirror cap.

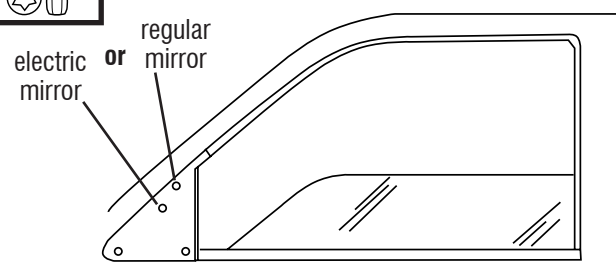

2

NOTE: If vehicle is equipped with electric mirror, the mirror assembly needs to be tilted down to expose third screw. **Chevy Astro & Dodge Dakota** use putty knife (see fig.4)

Installation Steps

NOTE: Actual application may vary slightly from illustrations.

Remove tape liner from rear flange. Peel back 2" (5 cm) of tape liner from each end of top flange.

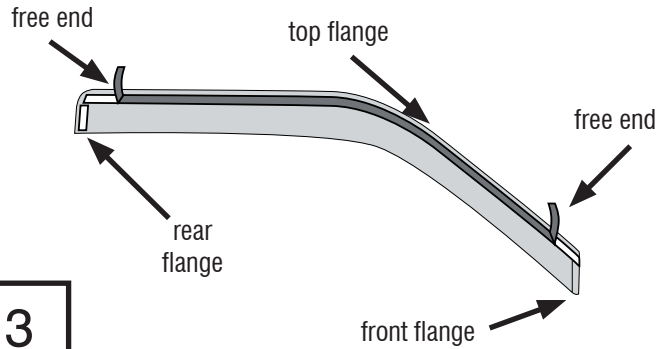

3



Align the driver side visor with the previously cleaned rubber trim. Slide the front end flange under the mirror cap (For Dakota and Astro van only, use a putty knife to assist placement). Press on areas of exposed tape to secure in place.

slide under mirror cap

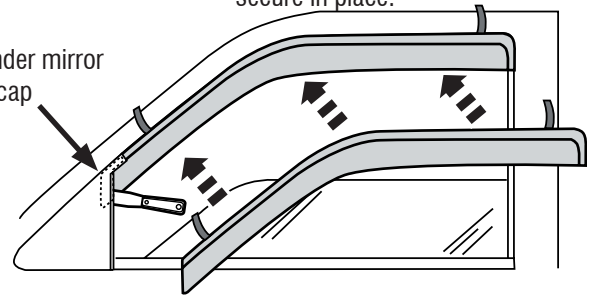

4

With the visor in its final position, remove the remaining tape liner by pulling on free ends.

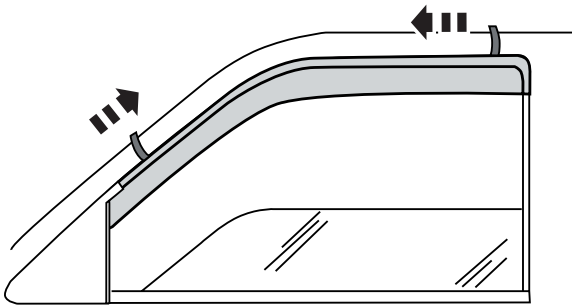

5

Apply pressure along the flange edges to secure in place. Tighten screws if previously loosened.

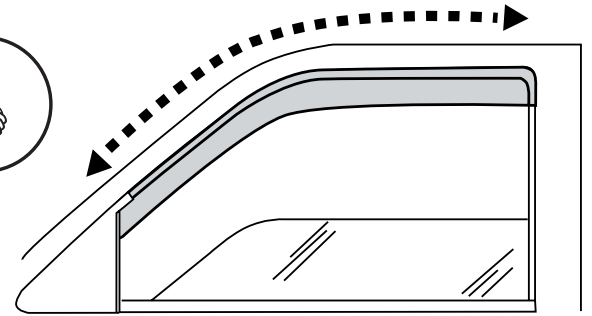

6

Repeat **Steps 1-6** for passenger side front visor.

4 Piece Set

The driver side rear visor attaches to the vehicle as shown, using the same procedures. Repeat for passenger side.

rear visor in final position

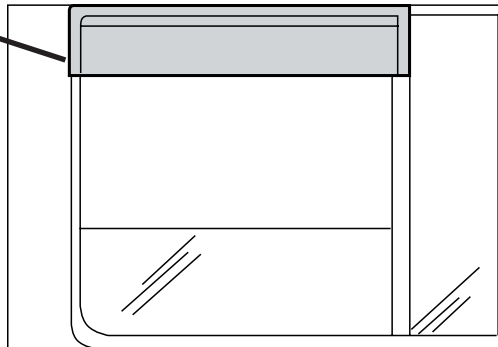

or

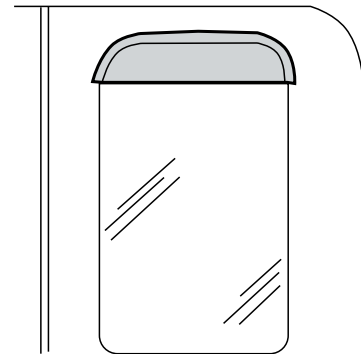

7

Care and Cleaning

- Wash only with mild soap & dry with a clean cloth.

Congratulations!

You have purchased one of the many quality Auto Ventshade™ branded products offered by Lund International, Inc. We take the utmost pride in our products and want you to enjoy years of satisfaction from your investment. We have made every effort to ensure that your product is top quality in terms of fit, durability, finish and ease of installation.

