

# Installation Instructions



## Ventvisor® Deflector

### Important Safety Information



- CAUTION - Before driving, ensure that the wind deflector is properly secured to vehicle.
- Do not use automatic “brush-style” car washes.
- Do not use cleaning solvents of any kind.
- Periodically check all components for tightness.

### Contents - 2 Piece Set

**NOTE:** Actual product may vary from illustration.

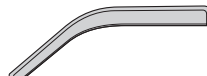

Front Driver  
Side Visor

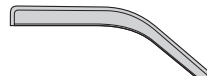

Front Passenger  
Side Visor



Alcohol  
Pad x2

### Contents - 4 Piece Set



Front Driver  
Side Visor



Front Passenger  
Side Visor



Rear Driver  
Side Visor



Rear Passenger  
Side Visor



Alcohol  
Pad x4

### Tools Required

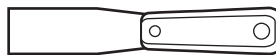

Putty Knife

### Preparation Before Painting / Installation

- A trial fit is recommended to ensure proper positioning and fit.
- Check fit of parts before painting as we will not accept the return of modified or painted parts.
- Wash your vehicle to remove any debris and/or dirt from installation area.
- Dry the installation area with a clean towel.

# Installation Steps

**NOTE:** Actual application may vary slightly from illustrations.

Alcohol Pad

Lower the window. Clean the window frame or the chrome window frame where the visor will attach.

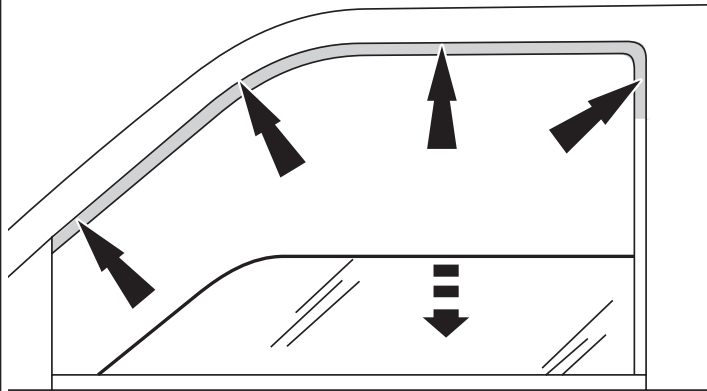

1

Remove the tape liner from the rear flange. Peel back 2" of tape liner from each end of top flange.

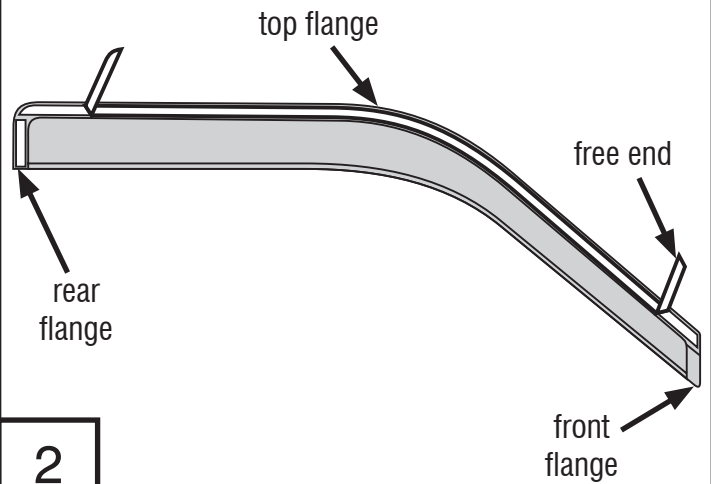

2

Slide the front flange behind the mirror cap, use a putty knife to create a gap if needed. Attach the top and rear flanges to the door's window frame or chrome window frame.

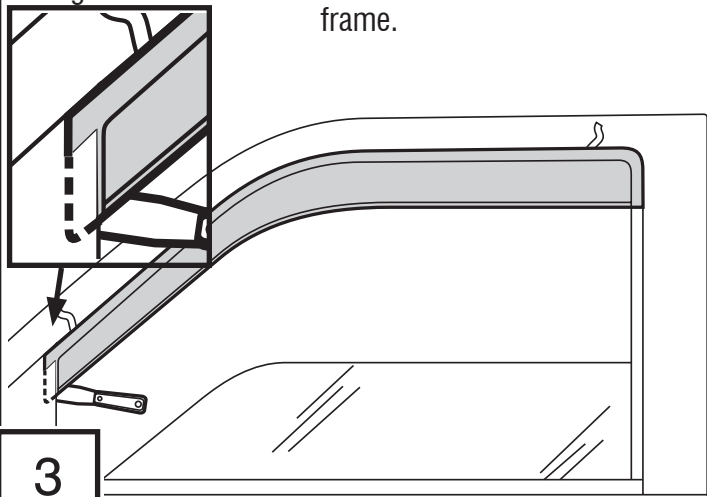

3

Remove tape liner by pulling on free ends. Apply pressure to top and rear tape flanges to secure. Raise the window.

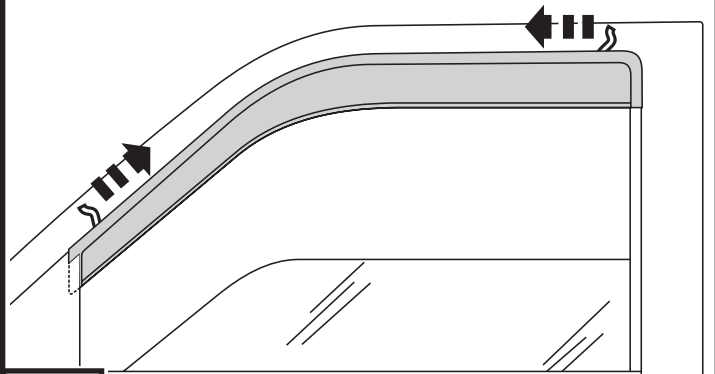

4

## 4 Piece Set

The rear visor attaches with same preparation methods as the front visor. Attach visor to the window frame or chrome window frame.

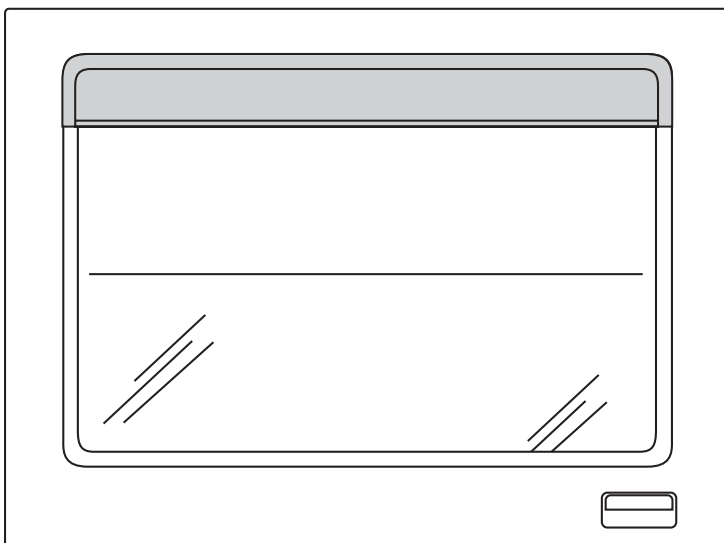

5

OR

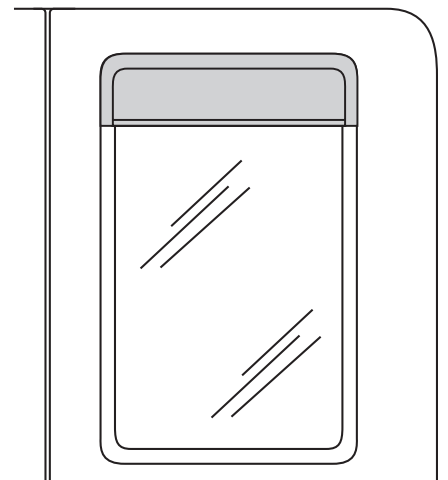

## Care and Cleaning

- Wash only with mild soap & dry with a clean cloth.

## Congratulations!

You have purchased one of the many quality Auto Ventshade™ branded products offered by Lund International, Inc. We take the utmost pride in our products and want you to enjoy years of satisfaction from your investment. We have made every effort to ensure that your product is top quality in terms of fit, durability, finish and ease of installation.



Check out the collection of rain guards and wind deflectors we offer.