

Installation Instructions



Ventvisor® Deflector

Important Safety Information



- CAUTION - Before driving, ensure that the vent visor is properly secured to vehicle.
- Do not use automatic "brush-style" car washes.
- Do not use cleaning solvents of any kind.
- Periodically check all components for tightness.

Contents **NOTE:** Actual product may vary from illustration.



Front Driver Side Visor



Front Passenger Side Visor



Alcohol Pad
x2

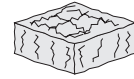

Scotch Brite pad

Tools Required



Car Wash Supplies



Clean Towel

Preparation Before Painting / Installation

- A trial fit is recommended to ensure proper positioning and fit.
- Check fit of parts before painting as we will not accept the return of modified or painted parts.
- Wash and dry your vehicle to remove any debris and/or dirt from the installation area.

Installation Steps **NOTE:** Actual application may vary slightly from illustrations.

Lower drivers side window completely.

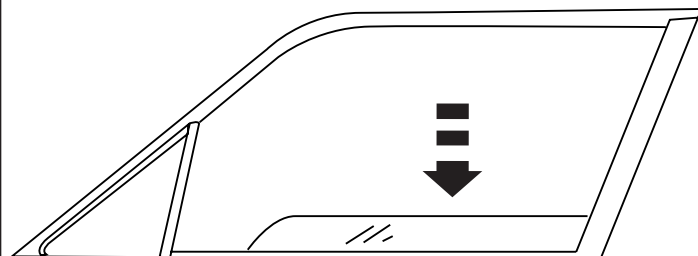

1



Buff the **INSIDE** of the rubber window channel with the scotch brite pad, then clean with an alcohol pad. Dry with a soft cloth.

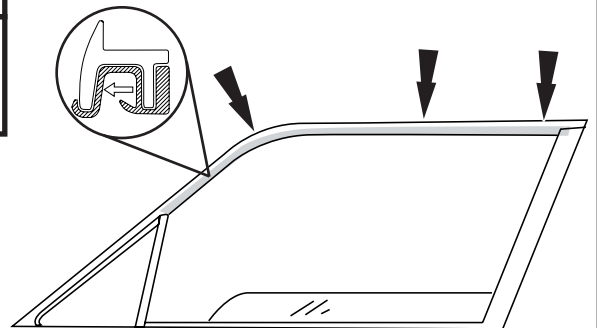

2

Installation Steps

NOTE: Actual application may vary slightly from illustrations.

Remove tape liner from front and rear flanges. Peel back 2" of tape liner from each end of lateral flange.

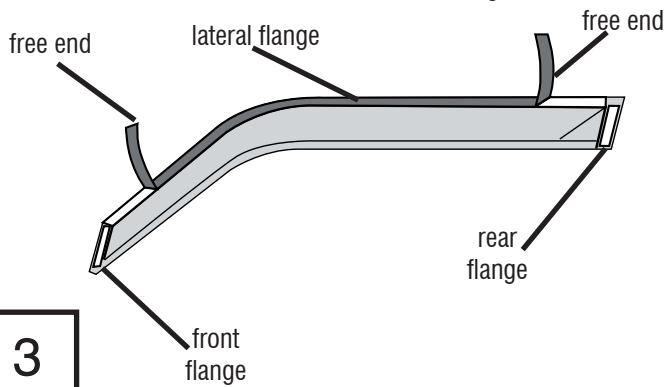

3

Align the part with the previously prepared areas.

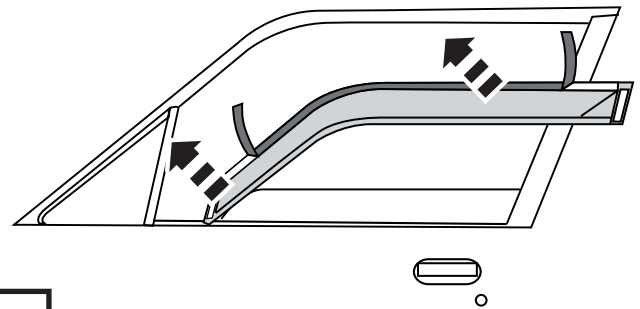

4

The front end flange will insert between the vent post and the rubber window channel. You will need to slightly pull the top portion of the rubber window channel out of the vent post. The lateral and end flanges will insert **INSIDE** of the rubber window channel. Make sure free ends are accessible.

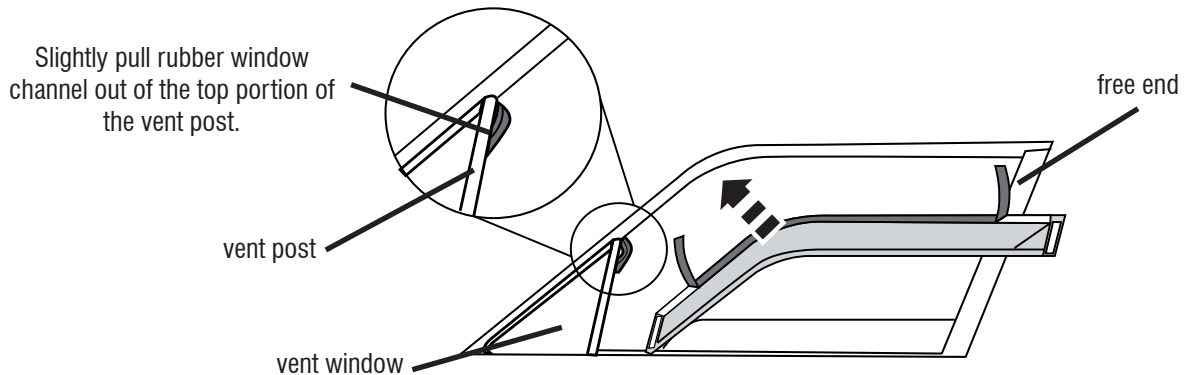

5

With the visor in its final position, remove the remaining tape liner by pulling on free ends.

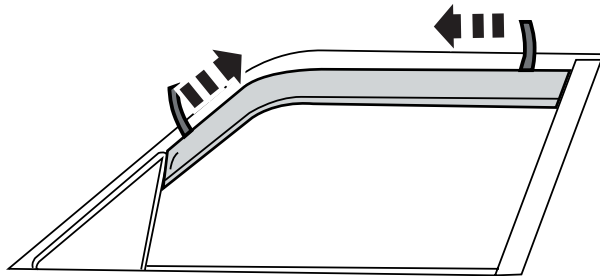

6

Apply pressure along all flanges to ensure proper adhesion of tape. Press the rubber window channel at the top of the vent post back into position. Roll window back up and leave for 24 hrs for tape adhesive to cure.

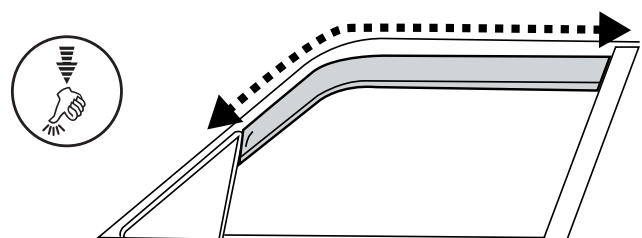

7

Repeat **Steps 1-7** for opposite side.

Care and Cleaning

- Wash only with mild soap & dry with a clean cloth.

Congratulations!

You have purchased one of the many quality Auto Ventshade™ branded products offered by Lund International, Inc. We take the utmost pride in our products and want you to enjoy years of satisfaction from your investment. We have made every effort to ensure that your product is top quality in terms of fit, durability, finish and ease of installation.

