

Installation Instructions



AUTO VENT SHADE™

Ventvisor® Deflector

Important Safety Information



- CAUTION - Before driving, ensure that the vent visor is properly secured to vehicle.
- Do not use automatic "brush-style" car washes.
- Do not use cleaning solvents of any kind.
- Periodically check all components for tightness.

Contents - 2 Piece Set **NOTE:** Actual product may vary from illustration.



Front Driver Side Visor



Front Passenger Side Visor



Alcohol Pad x2

Contents - 4 Piece Set



Front Driver Side Visor



Front Passenger Side Visor



Rear Driver Side Visor

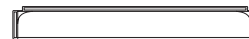

Rear Passenger Side Visor



Alcohol Pad x4

Tools Required



Car Wash Supplies

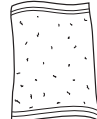

Clean Towel

Preparation Before Painting / Installation

- A trial fit is recommended to ensure proper positioning and fit.
- Check fit of parts before painting as we will not accept the return of modified or painted parts.
- Wash and dry your vehicle to remove any debris and/or dirt from the installation area.

Installation Steps **NOTE:** Actual application may vary slightly from illustrations.



Clean the window channel with an alcohol pad.



1

Remove tape liner from front flange. Peel back 2" (5 cm) of tape line from each end of top flange.

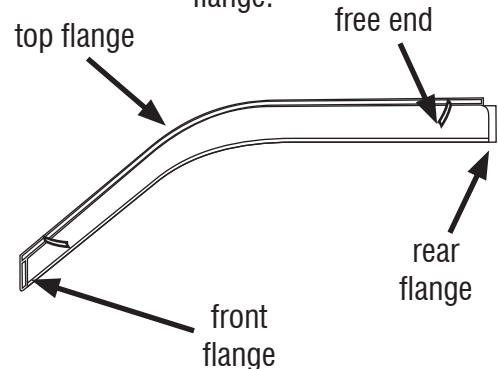

2

Installation Steps

NOTE: Actual application may vary slightly from illustrations.

Insert visor into window channel, rear flange first. Rear flange inserts between the rubber and frame. The front & top flange slides into the window channel.

NOTE: It may be necessary to pull the window channel out at the rear to seat the rear flange.

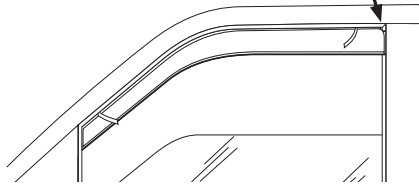
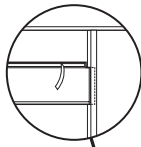

3

Remove tape liner by pulling on free ends. Raise window slowly and leave up for 24 hours to secure visor to window channel.

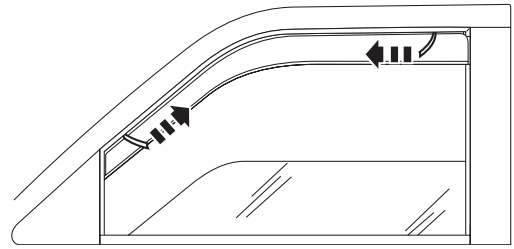

4

4 Piece Set

Install the rear visors using the same preparation and installation methods as the front visor. Note that front flange fits between the rubber and frame, and the rear flange attaches to the window post.

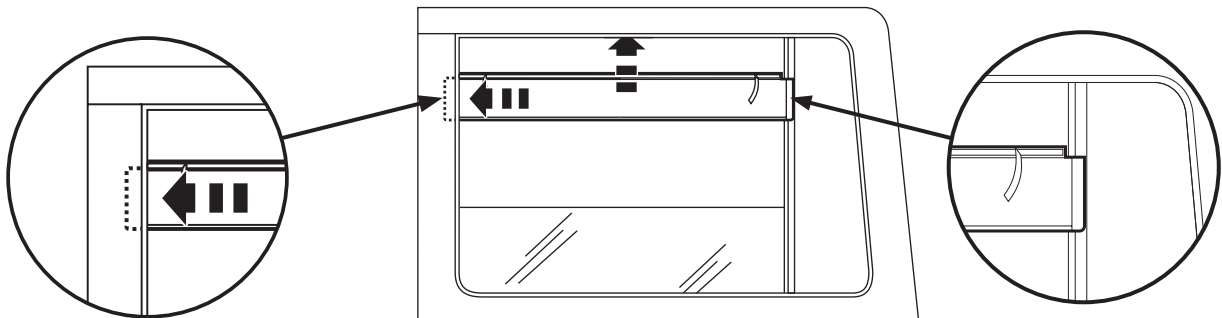

5

Care and Cleaning

- Wash only with mild soap & dry with a clean cloth.

Congratulations!

You have purchased one of the many quality Auto Ventshade™ branded products offered by Lund International, Inc. We take the utmost pride in our products and want you to enjoy years of satisfaction from your investment. We have made every effort to ensure that your product is top quality in terms of fit, durability, finish and ease of installation.

