

# Installation Instructions



## Bugflector® - Bugflector II® - Carflector® - Chrome Hood Shield™

### Important Safety Information



- CAUTION - Before driving, ensure that the hood shield is properly anchored to vehicle.
- Do not use automatic "brush-style" car washes.
- Do not use cleaning solvents of any kind.
- Periodically check all components for tightness.

### Contents **NOTE:** Actual product may vary from illustration.



Hood shield



Fastener x2



Bump On x4

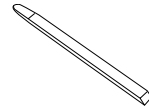

Pry Tool x1  
(Tundra ONLY)

### Tools Required



Car Wash Supplies

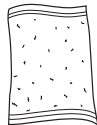

Clean Towel

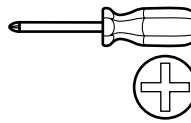

Phillips screw-  
driver

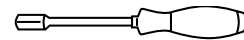

10mm Nut  
Driver

### Preparation Before Painting / Installation

- A trial fit is recommended to ensure proper positioning and fit.
- Check fit of parts before painting as we will not accept the return of modified or painted parts.
- Wash and dry your vehicle to remove any debris and/or dirt from the installation area.

### Installation Steps **NOTE:** Actual application may vary slightly from illustrations.

#### **NOTE: Steps 1 - 3 Tundra ONLY**

Locate the plastic applique on the grill.

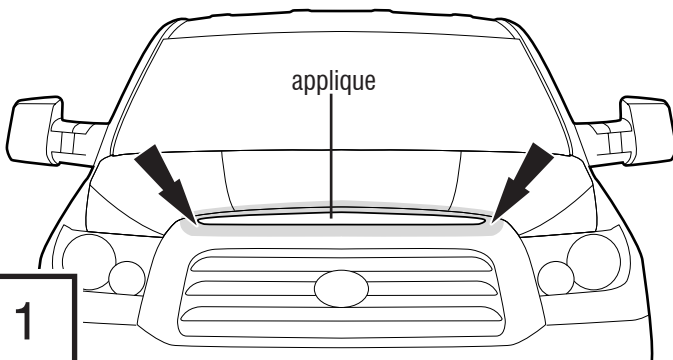

1



Using the Pry Tool provided, carefully pry the plastic applique away from the grill. Begin by lifting up the bottom drivers side corner and work your way across to the bottom passenger side corner. Remove applique.

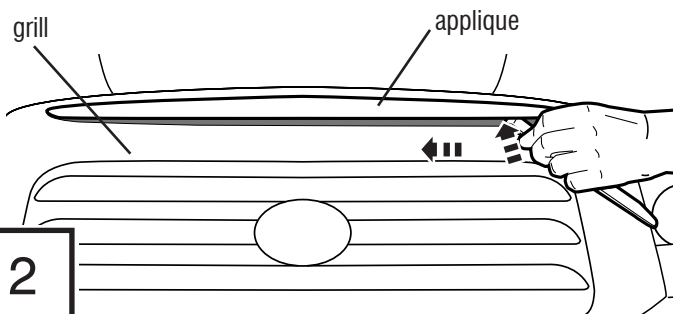

2

# Installation Steps

**NOTE:** Actual application may vary slightly from illustrations.



With the applique removed, use a 10mm nut driver to remove the (5) exposed bolts.

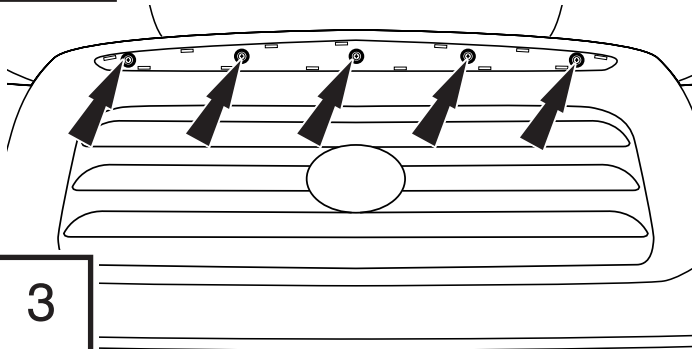

3

Carefully raise hood.

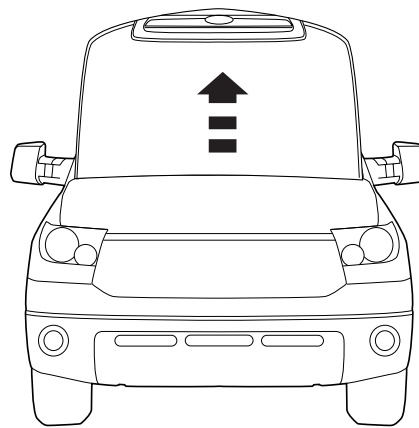

4

Reach under the hood to the backside of the grill and disconnect the hood lock rod from the grill by releasing the lock mechanism and gently lifting the rod away from grill.

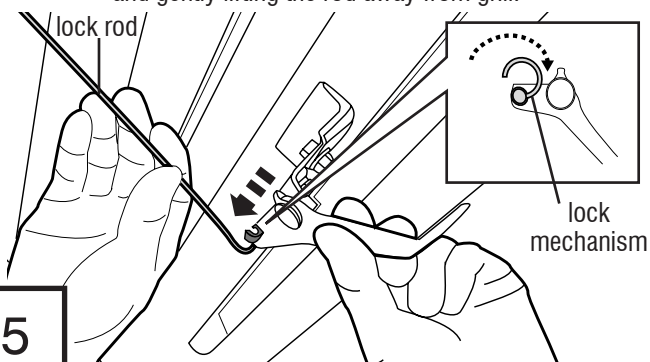

5



Reach under the hood to the backside of the grill, and using a nut driver remove (10) nuts.

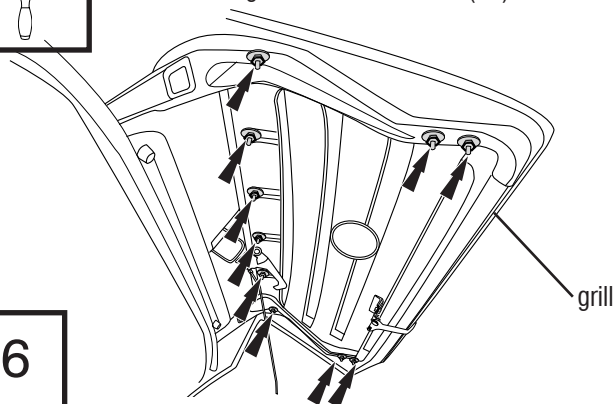

6

Carefully lower hood.

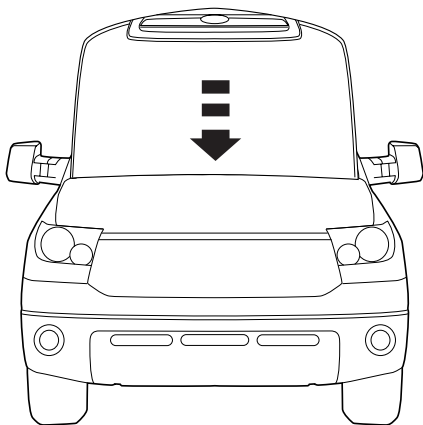

7



## **NOTE: Tundra ONLY**

Starting on the driver side top corner of the grill, and then the passenger side, use the Pry Tool provided to carefully pry the grill loose from the hood. Set grill aside.

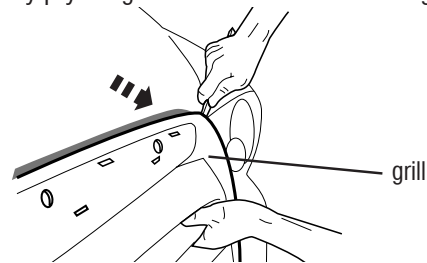

8

**NOTE:** The grill will make a "popping" noise as it separates from the vehicle. This is normal.



Clean front of hood edge, and carefully raise hood.

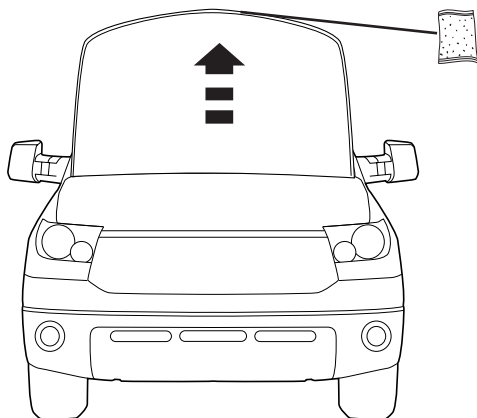

9

Align hood shield with hood edge.

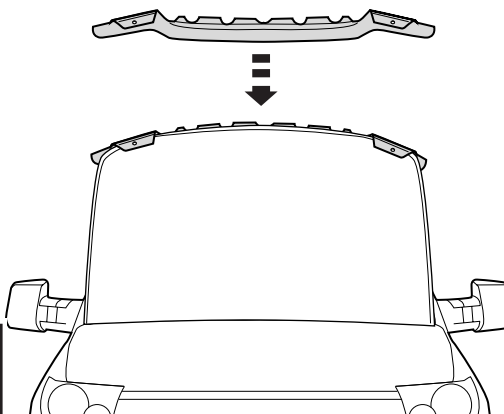

10

# Installation Steps

**NOTE:** Actual application may vary slightly from illustrations.

11

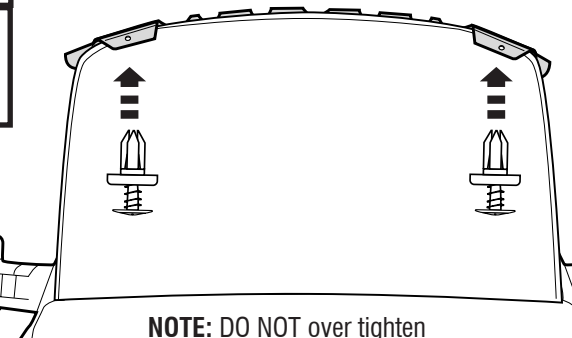

Align (2) holes in hood shield with holes in hood. Install a fastener in each hole.

**NOTE:** DO NOT over tighten

This diagram shows the hood shield being aligned with the hood. Two fasteners are shown being inserted into the holes. A note at the bottom states 'NOTE: DO NOT over tighten'. To the left of the main diagram are two small inset boxes: the top one shows a fastener with a spring washer, and the bottom one shows a screwdriver.

12

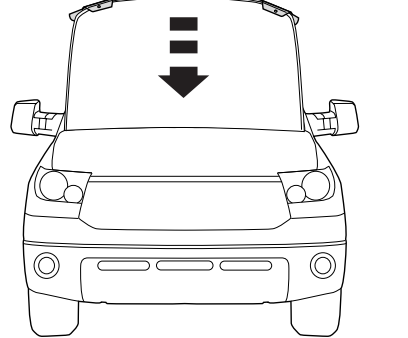

Carefully lower hood.

This diagram shows a front view of the vehicle with the hood being lowered. A large downward-pointing arrow with three horizontal bars above it indicates the direction of movement.

13

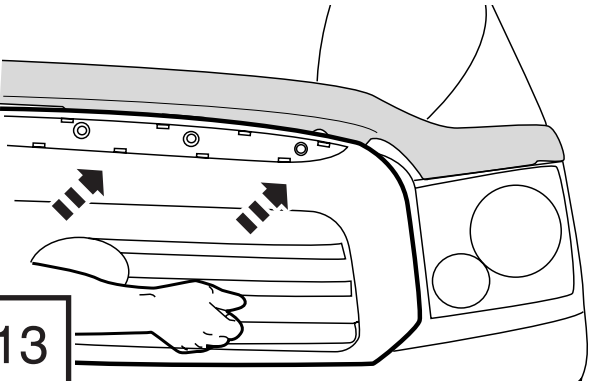

Reinstall grill by aligning with holes in hood edge. Ensure that the hood shield is **BETWEEN** the grill and the hood.

This diagram shows a hand aligning the grill with the hood edge. Two dashed arrows point towards the alignment points. The hood shield is shown between the grill and the hood.

14

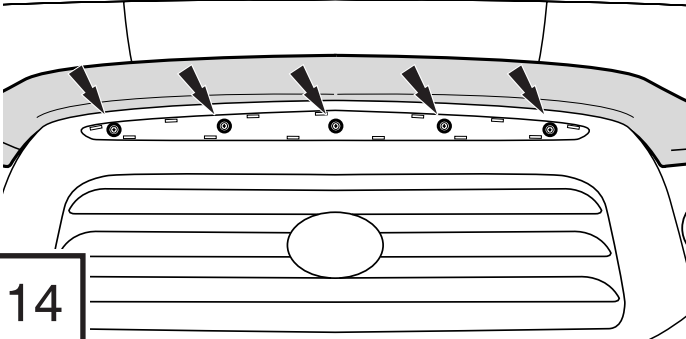

**NOTE: Tundra ONLY**  
Reattach the grill by reinstalling (5) bolts previously removed.

This diagram shows the grill being reattached to the hood edge. Five bolts are shown being inserted into the holes. A screwdriver icon is shown in the top left corner.

15

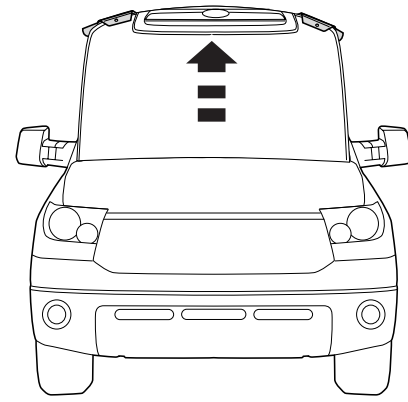

Carefully raise hood.

This diagram shows a front view of the vehicle with the hood being raised. A large upward-pointing arrow with three horizontal bars above it indicates the direction of movement.

16

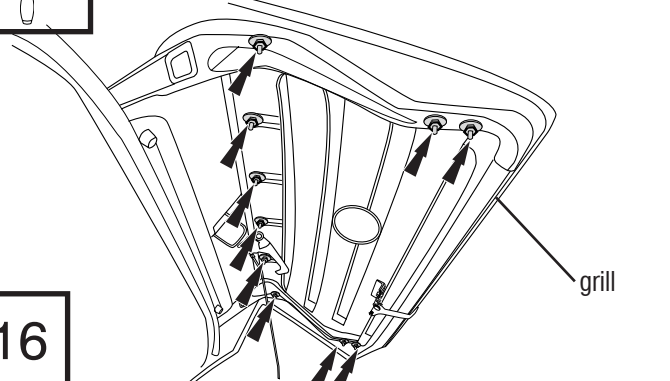

Reach under the hood to the backside of the grill, and reinstall (10) nuts previously removed.

grill

This diagram shows the backside of the grill with ten nuts being reinstalled. A screwdriver icon is shown in the top left corner. A label 'grill' points to the grill assembly.

17

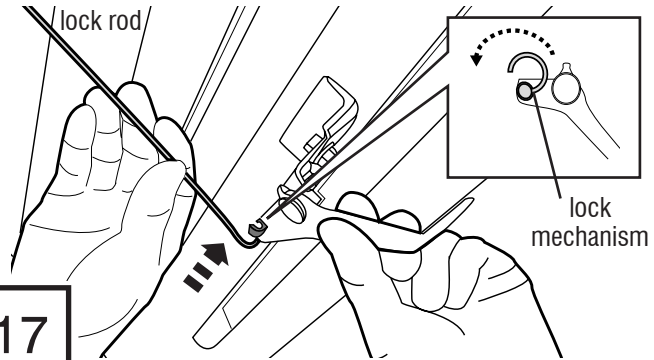

Reach under the hood to the backside of the grill and reattach the hood lock rod to the grill.

lock rod

lock mechanism

This diagram shows a hand reattaching the hood lock rod to the grill. A label 'lock rod' points to the rod, and a label 'lock mechanism' points to the attachment point. An inset diagram shows the lock mechanism being rotated.

18

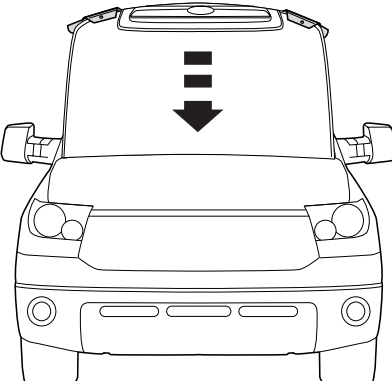

Carefully close hood.

This diagram shows a front view of the vehicle with the hood being closed. A large downward-pointing arrow with three horizontal bars above it indicates the direction of movement.

## Installation Steps

**NOTE:** Actual application may vary slightly from illustrations.

### NOTE: Tundra ONLY

Carefully reinstall the previously removed applique. Slide the top clips in first, then press firmly to snap remaining tabs into place.

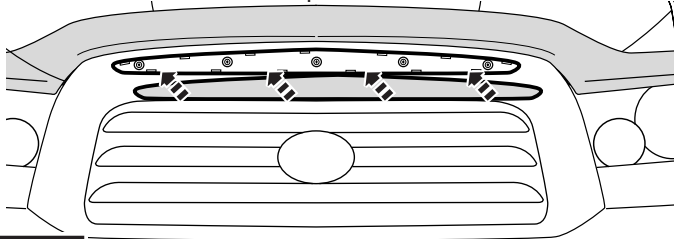

19



Apply (4) Bump ons to hood surface.

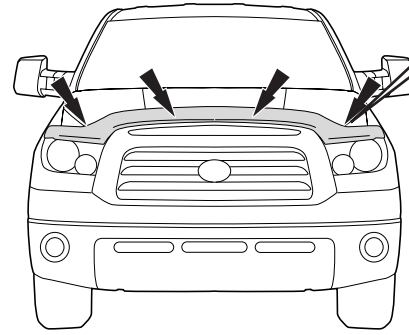

20

## Care and Cleaning

- Wash only with mild soap & dry with a clean cloth.

## Congratulations!

You have purchased one of the many quality Auto Ventshade™ branded products offered by Lund International, Inc. We take the utmost pride in our products and want you to enjoy years of satisfaction from your investment. We have made every effort to ensure that your product is top quality in terms of fit, durability, finish and ease of installation.



Rely on premium stone and bug deflectors by AVS if you're looking for quality and efficiency.