

Installation Instructions



Bugflector[®] - Bugflector II[®] - Carflector[®] - Chrome Hood Shield[™]

Important Safety Information



- CAUTION - Before driving, ensure that the hood shield is properly anchored to vehicle.
- Do not use automatic "brush-style" car washes.
- Do not use cleaning solvents of any kind.
- Periodically check all components for tightness.

Contents



Hood Shield



bump-on
x4

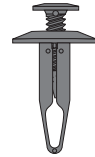

Fastener
x2

Tools Required

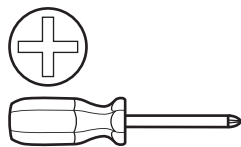

Screwdriver

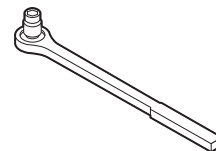

Socket Set

Preparation Before Painting / Installation

- A trial fit is recommended to ensure proper positioning and fit.
- Check fit of parts before painting as we will not accept the return of modified or painted parts.
- Wash your vehicle's hood to remove any debris and/or dirt.
- Dry the hood with a clean towel.

Installation Steps

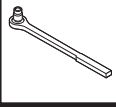

Raise hood. Remove and keep front grill hardware. Remove grill.

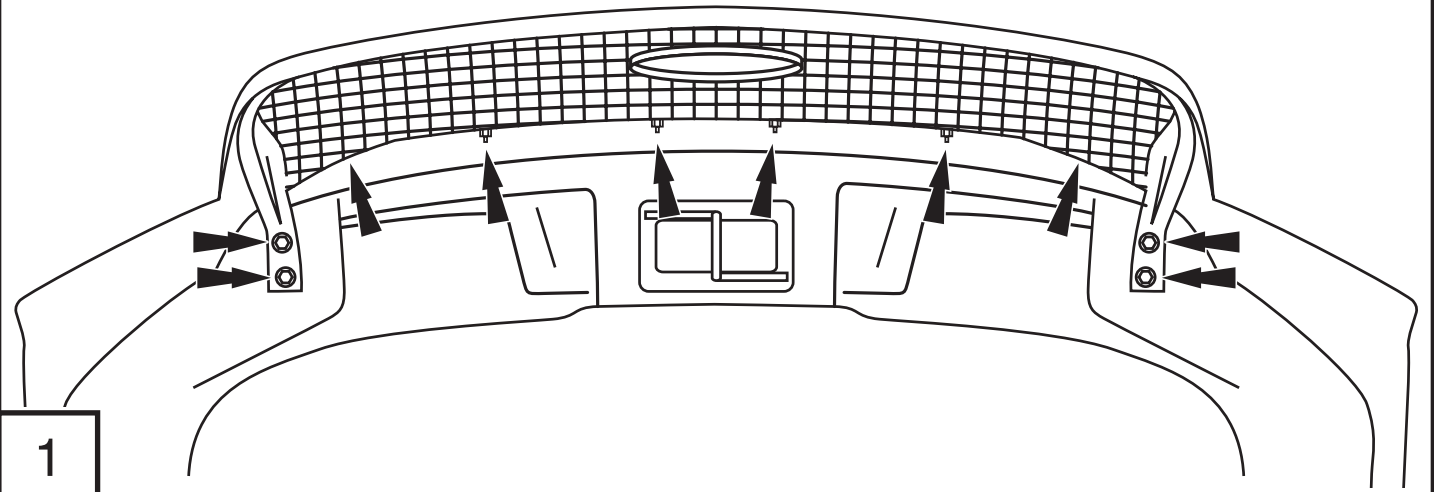

1

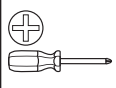

Align hood shield on center of hood. Secure with (2) fasteners. **DO NOT OVERTIGHTEN.**

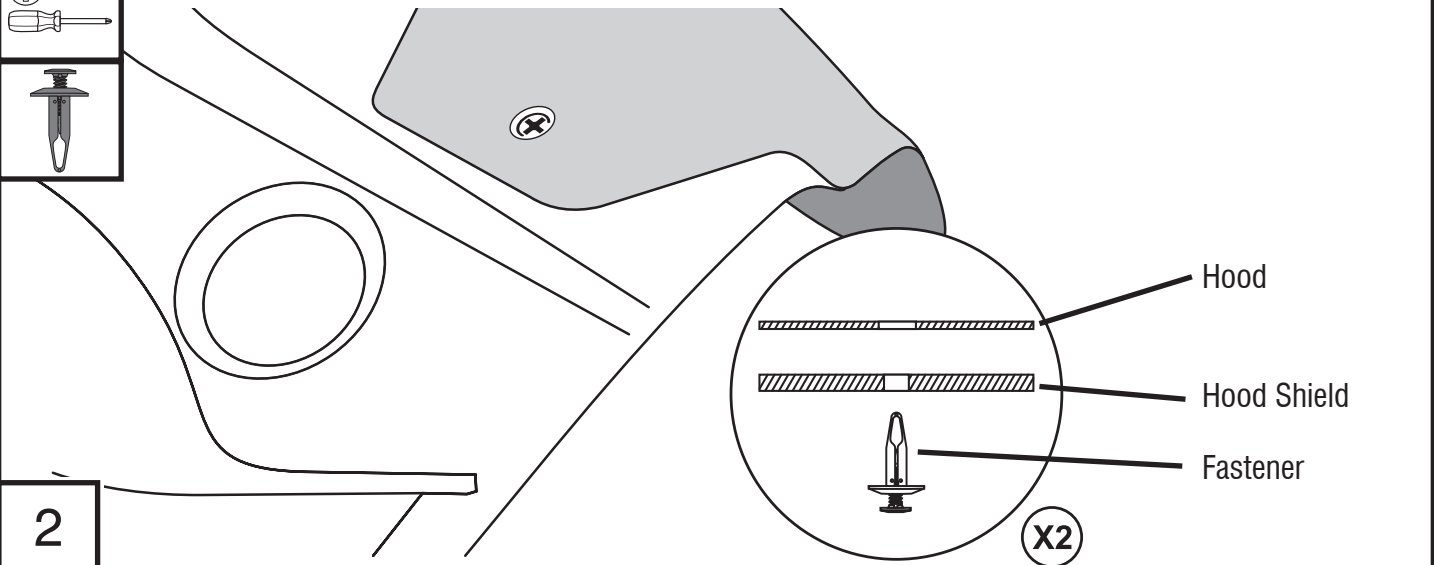

2



Replace grill with hardware.

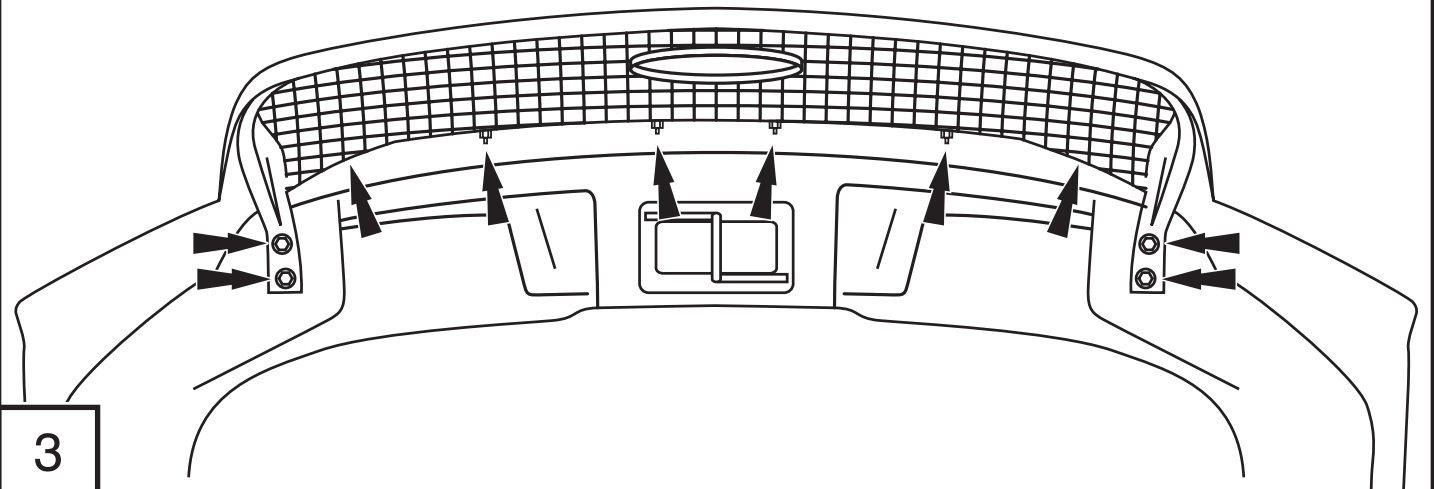

3

Installation Steps



Close hood. Apply bump-ons to hood behind hood shield.

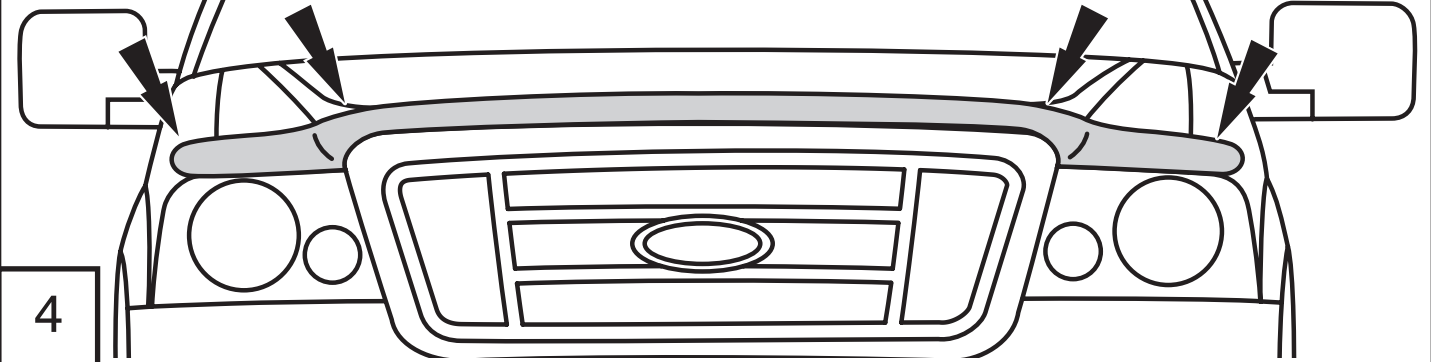
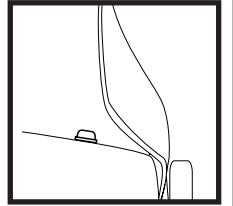

Care and Cleaning

- Wash only with mild soap & dry with a clean cloth.

Congratulations!

You have purchased one of the many quality items offered by Auto Ventshade. We take the utmost pride in our products and want you to enjoy years of satisfaction from your investment. We have made every effort to ensure that your product is top quality in terms of fit, durability, finish and ease of installation.



Check out the collection of stone and bug deflectors we offer.