

Installation Instructions



Bugflector[®] - Bugflector II[®] - Carflector[®] - Chrome Hood Shield[™]

Important Safety Information



- CAUTION - Before driving, ensure that the hood shield is properly anchored to vehicle.
- Do not use automatic “brush-style” car washes.
- Do not use cleaning solvents of any kind.
- Periodically check all components for tightness.

Contents **NOTE:** Actual product may vary from illustration.



Hood Shield



Alcohol Pad x2



Washer x4



Self Tapping
Screw x4



Bump On x2

Tools Required



Car Wash Supplies



Clean Towel

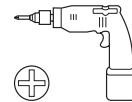

Appropriate hand tools

Preparation Before Painting / Installation

- A trial fit is recommended to ensure proper positioning and fit.
- Check fit of parts before painting as we will not accept the return of modified or painted parts.
- Wash your vehicle's hood to remove any debris and/or dirt.
- Dry the hood with a clean towel.

Installation Steps **NOTE:** Actual application may vary slightly from illustrations.

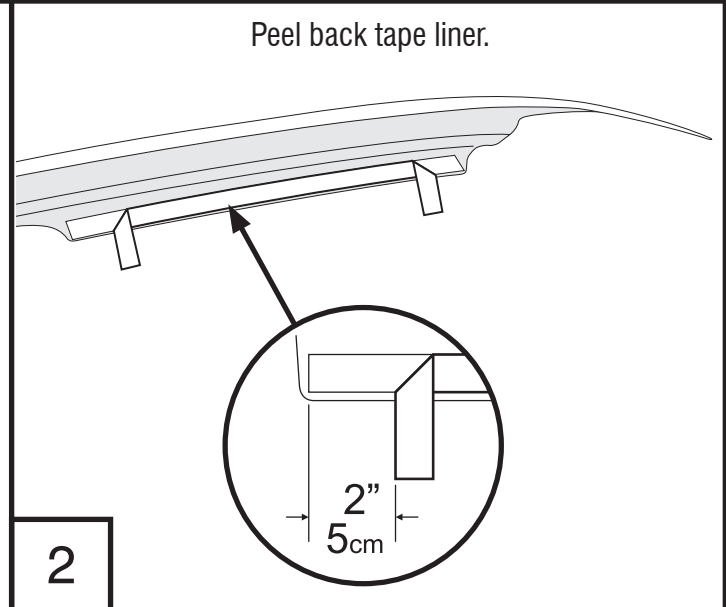
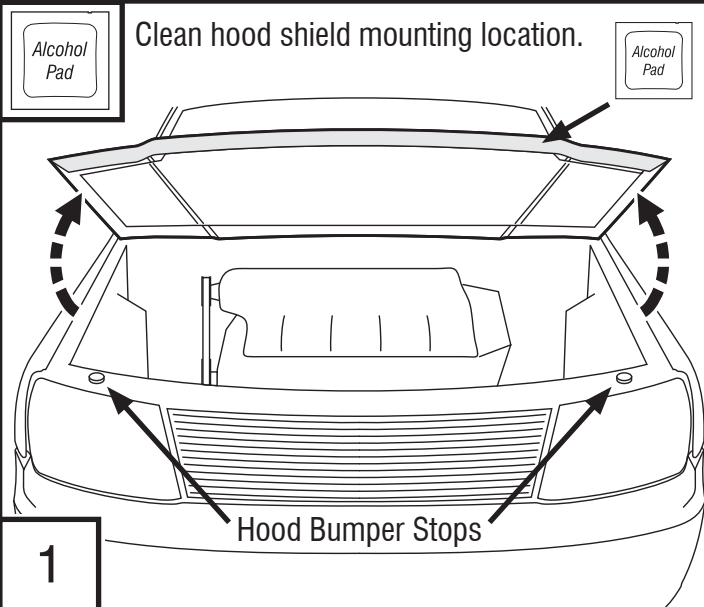

Installation Steps

NOTE: Actual application may vary slightly from drawings.

Center hood shield and attach with exposed tape. Remove tape liner.

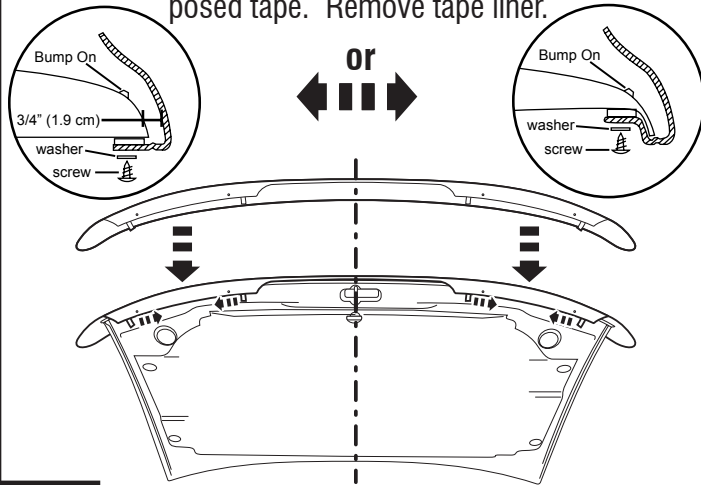

3

NOTE: The hood shield should be offset approximately 3/4" (1.9 cm) from the front edge of hood.

Apply pressure to tape flange.

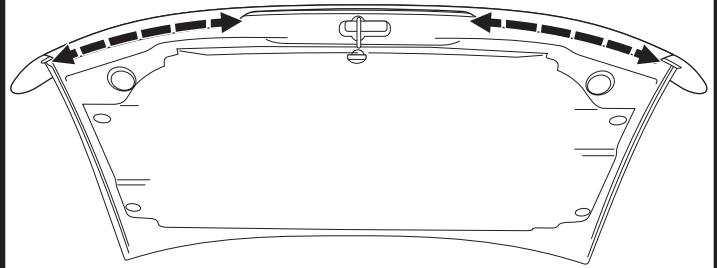

4

Optional Screw Attachment

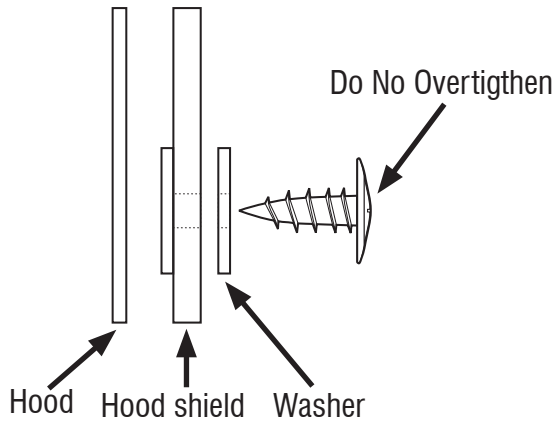

5

Lower hood, adjust hood bumper stops if necessary. Apply bump-ons to hood surface.

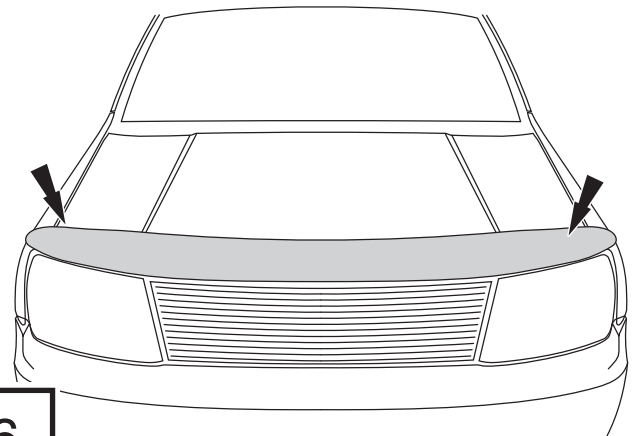

6

Care and Cleaning

- Wash only with mild soap & dry with a clean cloth.

Congratulations!

You have purchased one of the many quality Auto Ventshade™ branded products offered by Lund International, Inc. We take the utmost pride in our products and want you to enjoy years of satisfaction from your investment. We have made every effort to ensure that your product is top quality in terms of fit, durability, finish and ease of installation.



Check out the collection of stone and bug deflectors we offer.