

# Installation Instructions



Bugflector<sup>®</sup> - Bugflector II<sup>®</sup> - Carflector<sup>®</sup> - Chrome Hood Shield<sup>™</sup>

## Important Safety Information



- CAUTION - Before driving, ensure that the hood shield is properly secured to vehicle.
- Do not use automatic "brush-style" car washes.
- Do not use cleaning solvents of any kind.
- Periodically check all components for tightness.

## Contents **NOTE:** Actual product may vary from illustration.



Hood Shield

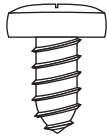

Phillips Screw x4

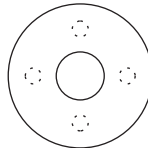

Plastic Washer x4



Alcohol Pad x2



Bump On x4

## Tools Required



Car Wash Supplies



Clean Towel

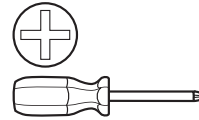

Phillips Screwdriver

## Preparation Before Painting / Installation

- A trial fit is recommended to ensure proper positioning and fit.
- Check fit of parts before painting as we will not accept the return of modified or painted parts.
- Wash and dry your vehicle to remove any debris and/or dirt from the installation area.

## Installation Steps **NOTE:** Actual application may vary slightly from illustrations.

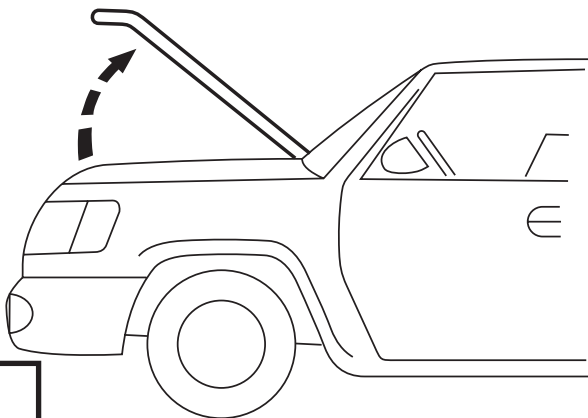

1

Center hood shield on hood. Note locations of (4) holes in hood shield and the corresponding locations on hood.

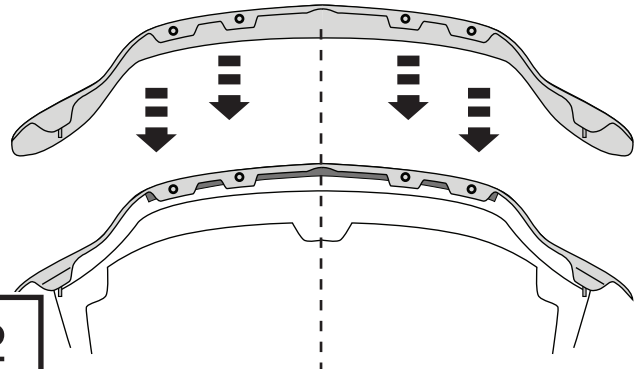

2

# Installation Steps

**NOTE:** Actual application may vary slightly from drawings.

Remove and discard (4) fasteners from hood weatherstrip noted in **Step 2**.

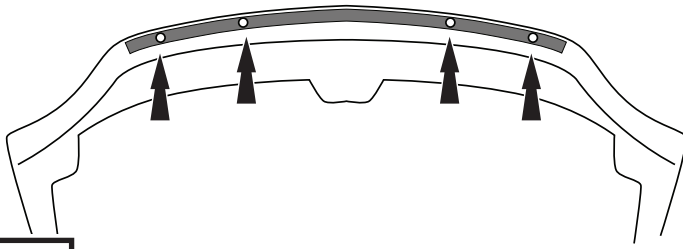

3

Clean **outboard** edges of hood with an alcohol pad.

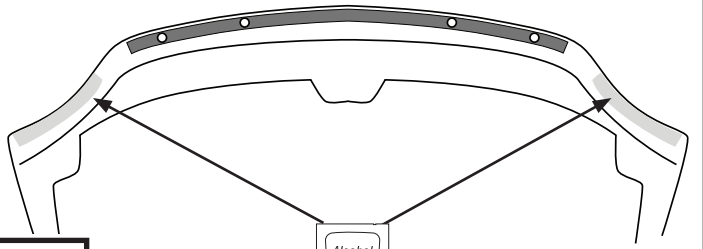

4

Peel back 2" (5cm) of tape liner from each end of hood shield.

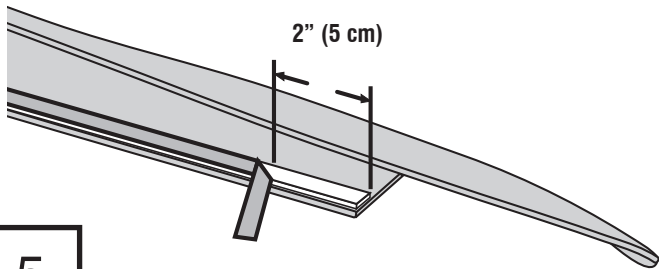

5

Carefully slide (4) **inboard** hood shield flanges **under** weatherstrip and align hood shield with holes in hood.

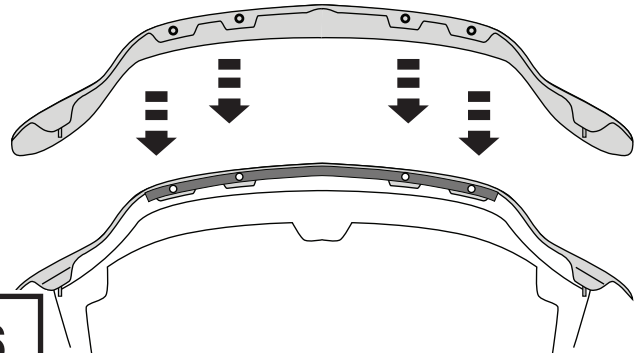

6

Install (4) phillips screws with washers as indicated.

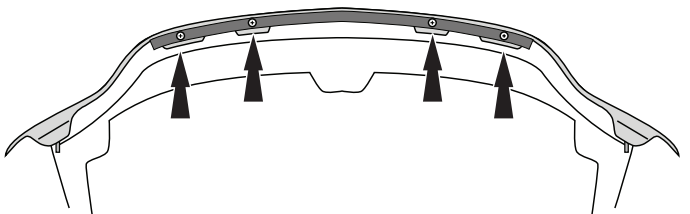
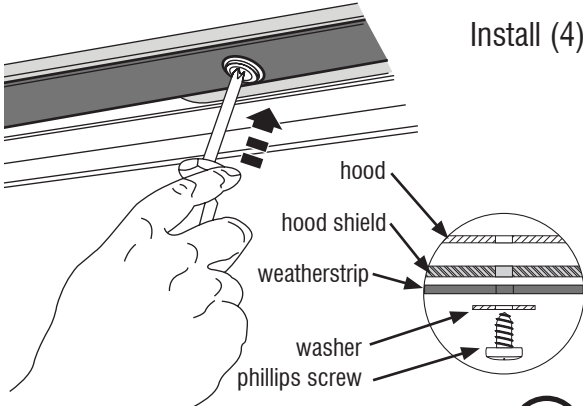
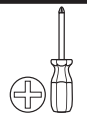
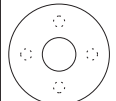
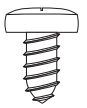

7

Do not overtighten

(X4)

Remove tape liner from both **outboard** flanges.

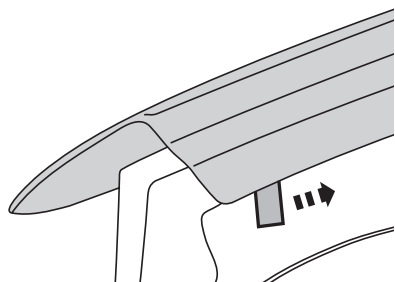

8

(X2)

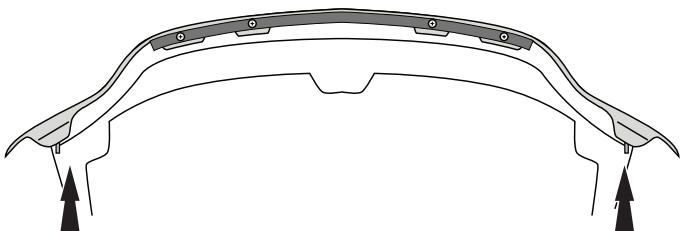

## Installation Steps

**NOTE:** Actual application may vary slightly from drawings.



Apply pressure to flanges to ensure adhesion to hood surface.

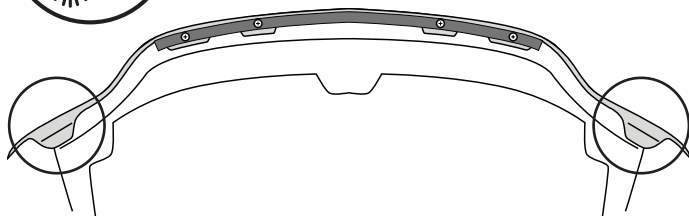

9

Close hood.

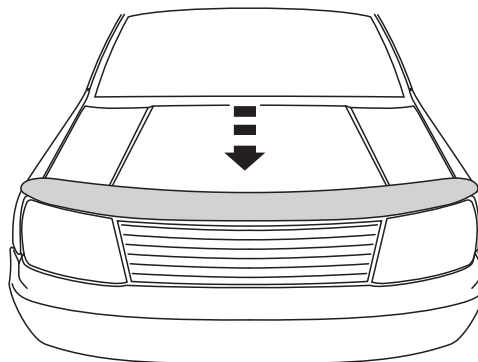

10



Apply bump ons at precleaned locations on hood surface.

X4

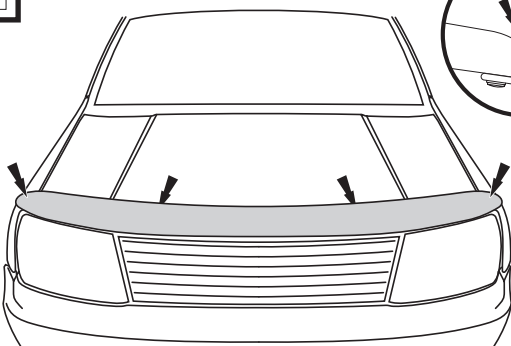
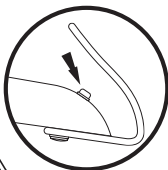

11

## Care and Cleaning

- Wash only with mild soap & dry with a clean cloth.

## Congratulations!

You have purchased one of the many quality Auto Ventshade™ branded products offered by Lund International, Inc. We take the utmost pride in our products and want you to enjoy years of satisfaction from your investment. We have made every effort to ensure that your product is top quality in terms of fit, durability, finish and ease of installation.



When it comes to quality stone and bug deflectors, AVS is the brand you can depend on.