

# Installation Instructions



## Bugflector® - Bugflector II® - Carflector®

### Important Safety Information



- CAUTION - Before driving, ensure that the hood shield is properly secured to vehicle.
- Do not use automatic "brush-style" car washes.
- Do not use cleaning solvents of any kind.
- Periodically check all components for tightness.

### Contents **NOTE:** Actual product may vary from illustration.



Hood shield



Bump On x4

### Tools Required



Car Wash Supplies

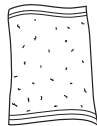

Clean Towel

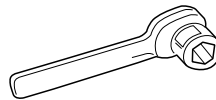

8 mm socket wrench

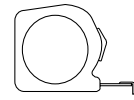

Measuring Tape

### Preparation Before Painting / Installation

- A trial fit is recommended to ensure proper positioning and fit.
- Check fit of parts before painting as we will not accept the return of modified or painted parts.
- Wash and dry your vehicle to remove any debris and/or dirt from the installation area.

### Installation Steps **NOTE:** Actual application may vary slightly from illustrations.

Raise hood.

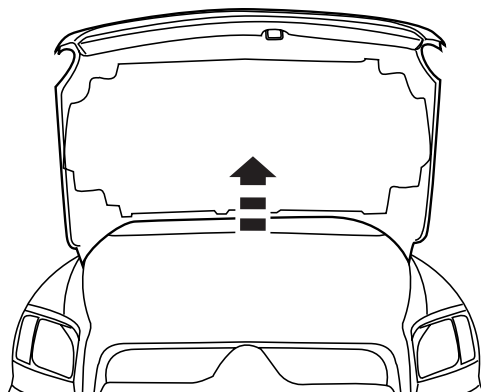

1



Loosen, but do not remove, (5) nuts securing grill to hood.

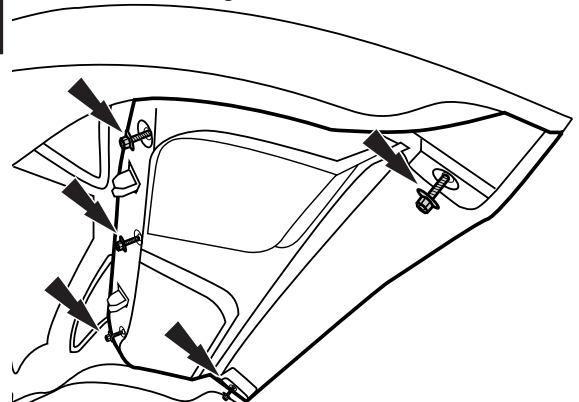

2

## Installation Steps **NOTE:** Actual application may vary slightly from illustrations.

Squeeze tabs of (2) retaining clips together to release the locking tabs.

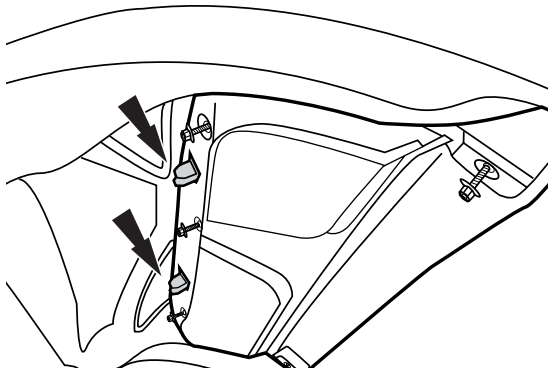

3



Lower the hood, and pivot the grill forward to create a 1/4" (.6 cm) gap between hood and grill.

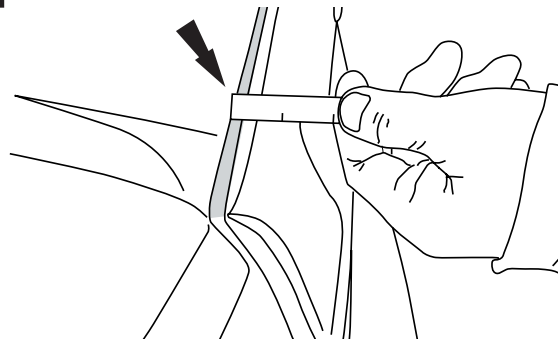

4

Slide the hood shield between the hood and grill, and center.

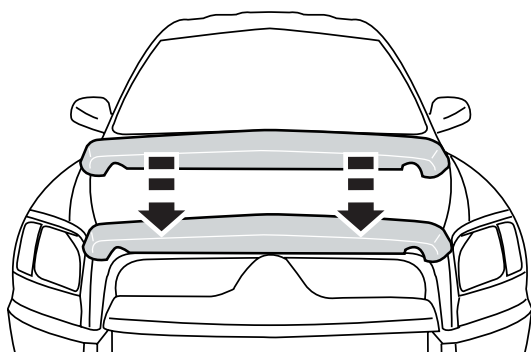

5



Raise hood, and retighten (5) previously loosened screws. Snap (2) retaining clips back into place.

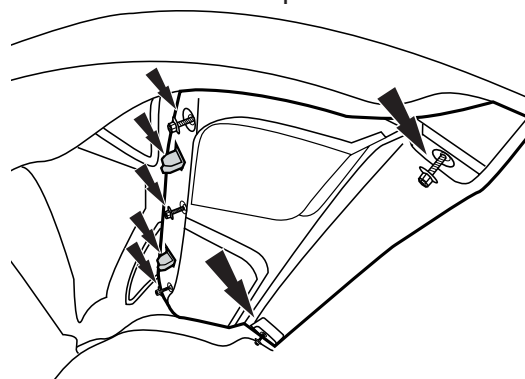

6



Install (4) bumpers on pre-cleaned areas of hood surface.

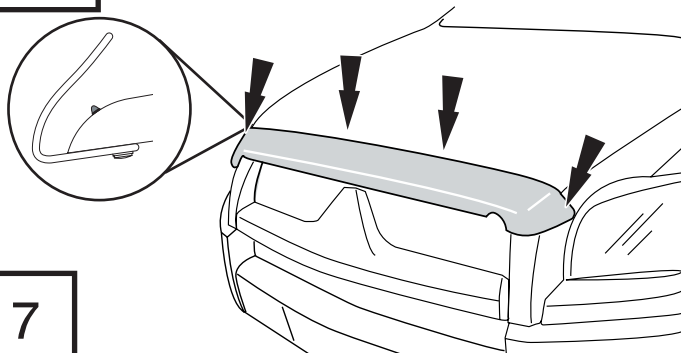

7

## Care and Cleaning

- Wash only with mild soap & dry with a clean cloth.

## Congratulations!

You have purchased one of the many quality Auto Ventshade™ branded products offered by Lund International, Inc. We take the utmost pride in our products and want you to enjoy years of satisfaction from your investment. We have made every effort to ensure that your product is top quality in terms of fit, durability, finish and ease of installation.



When it comes to quality stone and bug deflectors, AVS is the brand you can depend on.