

Installation Instructions



Bugflector® - Bugflector II® - Carflector®

Important Safety Information



- CAUTION - Before driving, ensure that the hood shield is properly secured to vehicle.
- Do not use automatic "brush-style" car washes.
- Do not use cleaning solvents of any kind.
- Periodically check all components for tightness.

Contents

NOTE: Actual product may vary from illustration.

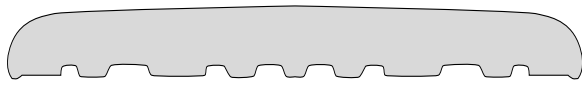

Hood shield



Fender Protector x2



Bump On x2



Screws x2

Tools Required



Car Wash Supplies



Clean Towel

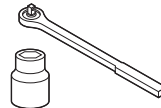

Socket Wrench

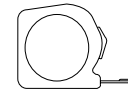

Measuring Tape

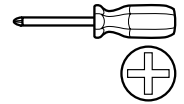

Phillips Screwdriver

Preparation Before Painting / Installation

- A trial fit is recommended to ensure proper positioning and fit.
- Check fit of parts before painting as we will not accept the return of modified or painted parts.
- Wash and dry your vehicle to remove any debris and/or dirt from the installation area.

Installation Steps

NOTE: Actual application may vary slightly from illustrations.

Open Hood.

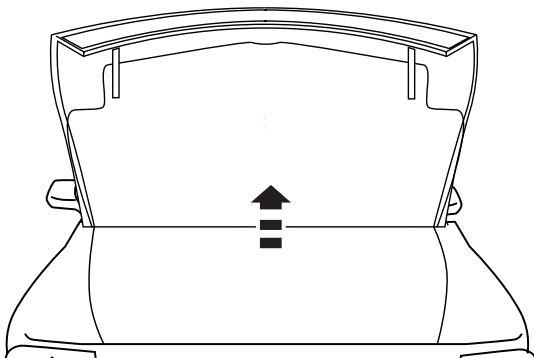

Locate frame that attaches to hood. Loosen, but do not remove (4) hex screws that attach to the underside of hood.

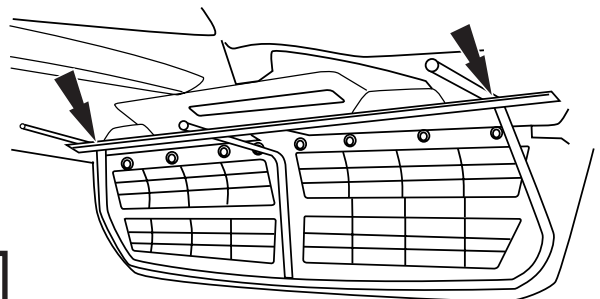

Installation Steps

NOTE: Actual application may vary slightly from illustrations.



Locate hex screws that the top of grill to hood. Loosen, but do not remove screws.

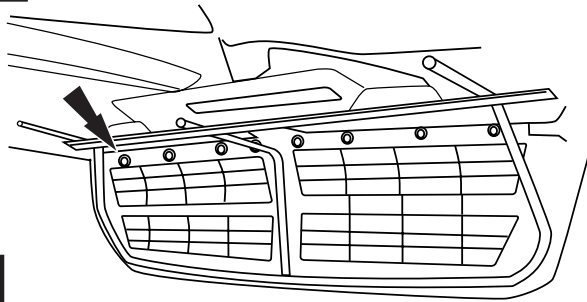

3



Lower hood and pivot grill forward to create a 1/8" gap between hood and grill.

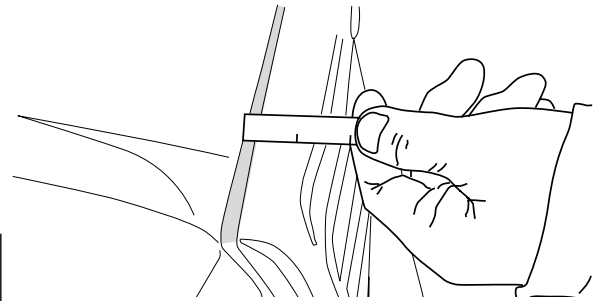

4

Slide hood shield between hood and grill until properly positioned. Retighten previously loosened hex screws.

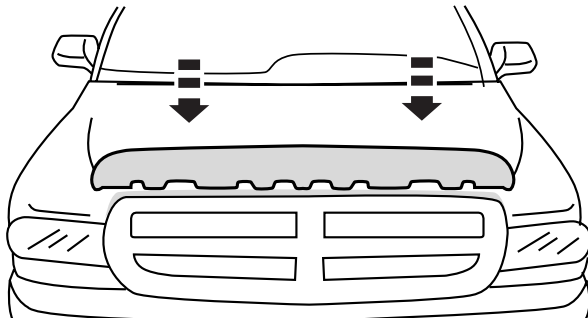

5

Fender Protector Installation

Place (1) bump on on the leading edge of fender above headlight 9" from edge of grill.

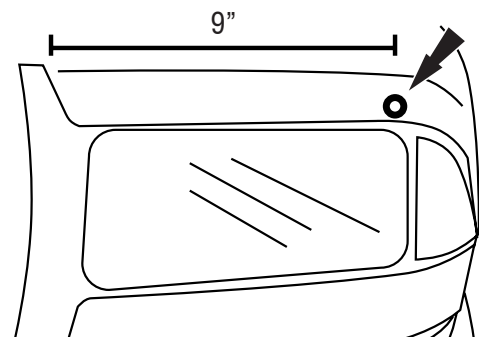

6

Expose sheet metal of hood by releasing the rubber seal near grill area. Discard plastic fastener.

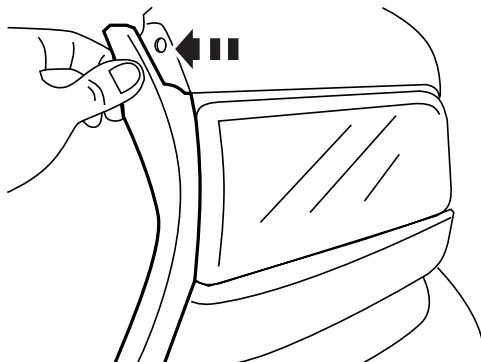

7

Slide protector tab behind main assembly by tilting while aligned with the space between the side marker and main headlight assembly.

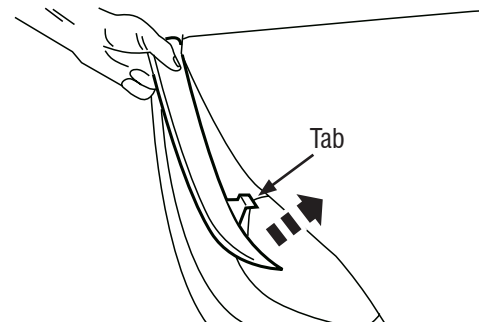

8

Align the predrilled hole in the protector with the hole in the sheet metal by sliding flange between the rubber and metal flange.

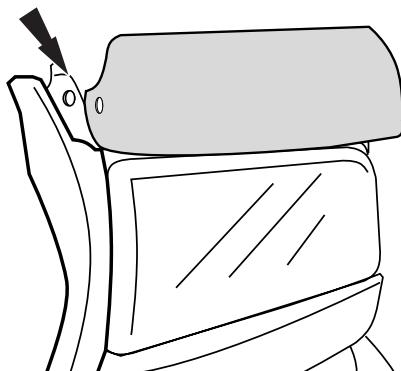

9

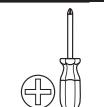

The self tapping screw replaces the previously discarded fastener. Secure deflector and rubber seal to sheet metal flange using this screw.

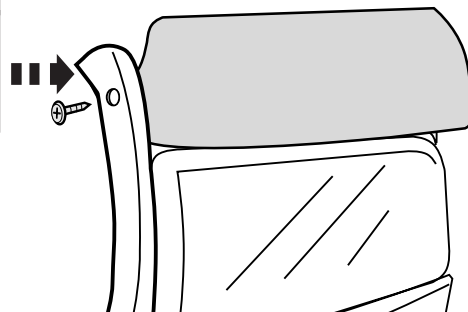

10

DO NOT OVER TIGHTEN

Installation Steps **NOTE:** Actual application may vary slightly from illustrations.

Repeat for opposite side fender protector.

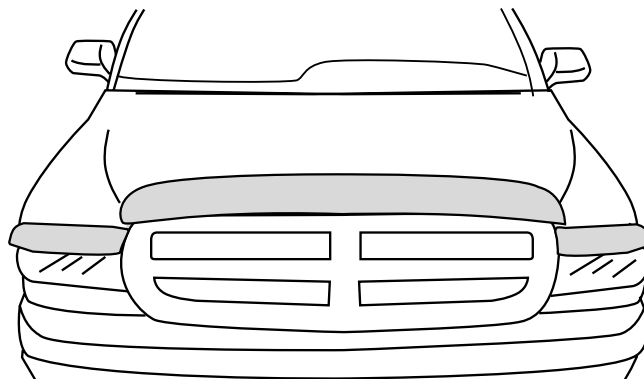

11

Care and Cleaning

- Wash only with mild soap & dry with a clean cloth.

Congratulations!

You have purchased one of the many quality Auto Ventshade™ branded products offered by Lund International, Inc. We take the utmost pride in our products and want you to enjoy years of satisfaction from your investment. We have made every effort to ensure that your product is top quality in terms of fit, durability, finish and ease of installation.



When it comes to quality stone and bug deflectors, AVS is the brand you can depend on.