

Installation Instructions



Bugflector® - Bugflector II® - Carflector® - Chrome Hood Shield™

Important Safety Information



- CAUTION - Before driving, ensure that the hood shield is properly anchored to vehicle.
- Do not use automatic "brush-style" car washes.
- Do not use cleaning solvents of any kind.
- Periodically check all components for tightness.

Contents **NOTE:** Actual product may vary from illustration.



Hood shield



Fastener x2



Bump On x4

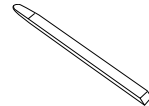

Pry Tool x1
(Tundra ONLY)

Tools Required



Car Wash Supplies

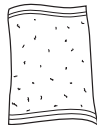

Clean Towel

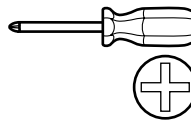

Phillips screw-
driver

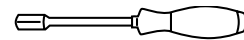

10mm Nut
Driver

Preparation Before Painting / Installation

- A trial fit is recommended to ensure proper positioning and fit.
- Check fit of parts before painting as we will not accept the return of modified or painted parts.
- Wash and dry your vehicle to remove any debris and/or dirt from the installation area.

Installation Steps **NOTE:** Actual application may vary slightly from illustrations.

NOTE: Steps 1 - 3 Tundra ONLY

Locate the plastic applique on the grill.

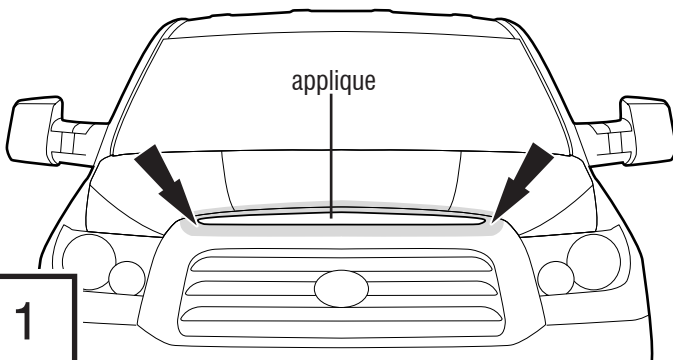

Using the Pry Tool provided, carefully pry the plastic applique away from the grill. Begin by lifting up the bottom drivers side corner and work your way across to the bottom passenger side corner. Remove applique.

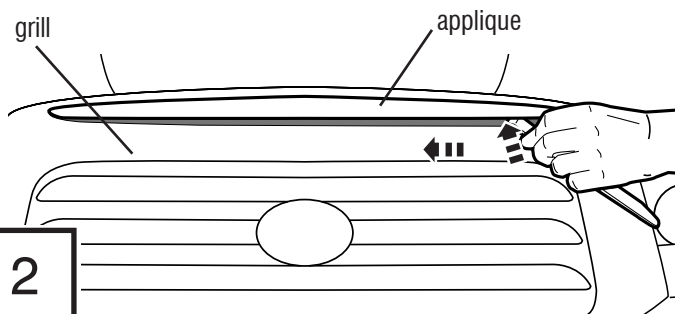

Installation Steps

NOTE: Actual application may vary slightly from illustrations.



With the applique removed, use a 10mm nut driver to remove the (5) exposed bolts.

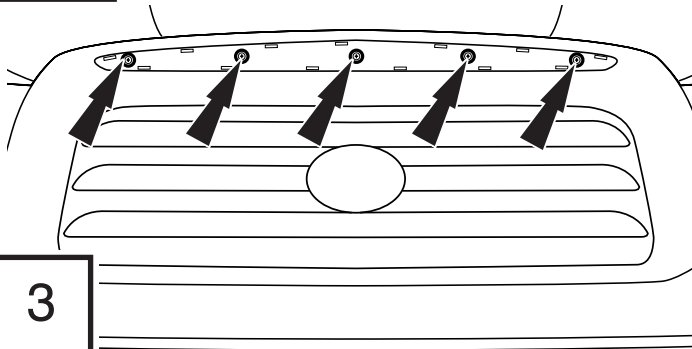

3

Carefully raise hood.

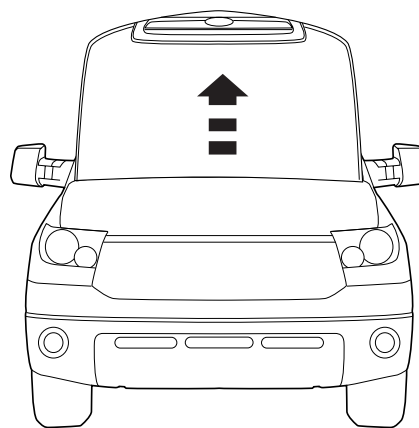

4

Reach under the hood to the backside of the grill and disconnect the hood lock rod from the grill by releasing the lock mechanism and gently lifting the rod away from grill.

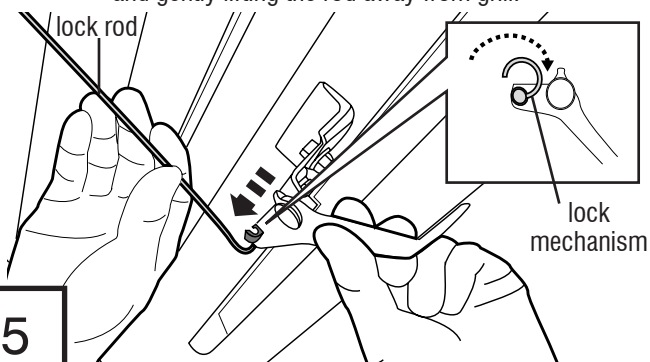

5



Reach under the hood to the backside of the grill, and using a nut driver remove (10) nuts.

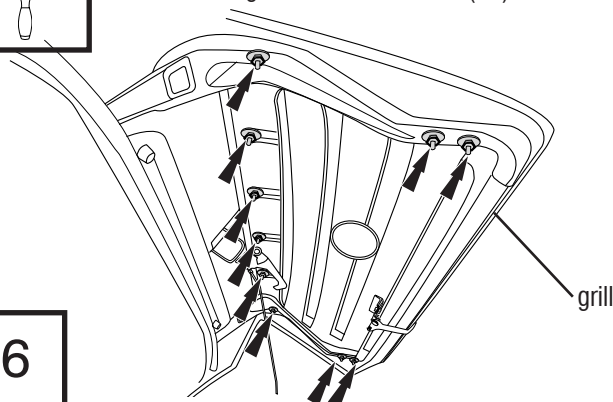

6

Carefully lower hood.

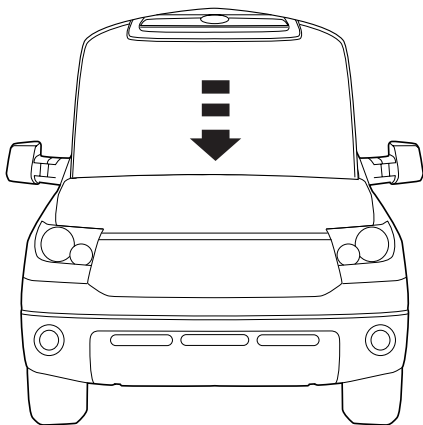

7



NOTE: Tundra ONLY

Starting on the driver side top corner of the grill, and then the passenger side, use the Pry Tool provided to carefully pry the grill loose from the hood. Set grill aside.

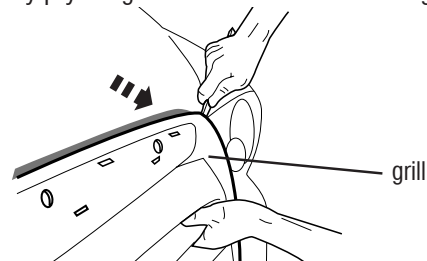

8

NOTE: The grill will make a "popping" noise as it separates from the vehicle. This is normal.



Clean front of hood edge, and carefully raise hood.

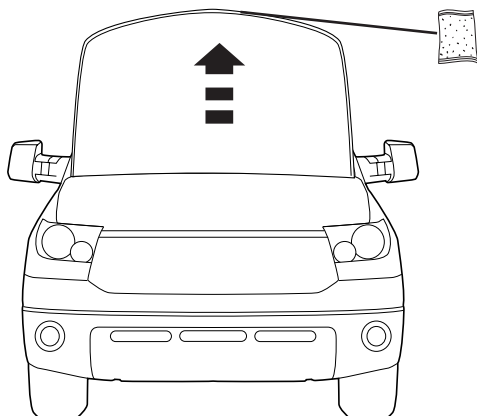

9

Align hood shield with hood edge.

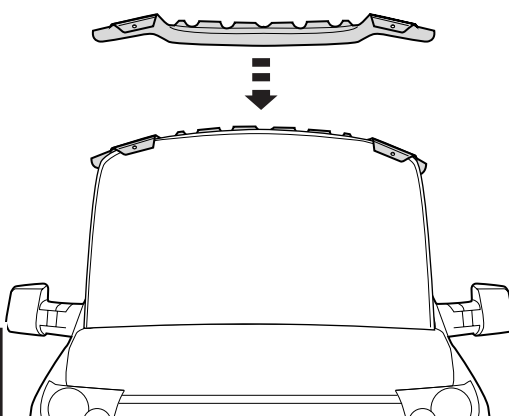

10

Installation Steps

NOTE: Actual application may vary slightly from illustrations.

Align (2) holes in hood shield with holes in hood.
Install a fastener in each hole.

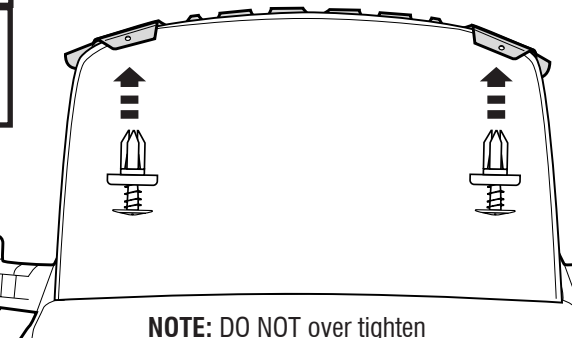

NOTE: DO NOT over tighten

11

This panel shows the installation of the hood shield. It includes two inset images: the top one shows a fastener being inserted into a hole, and the bottom one shows a screwdriver being used to tighten the fastener. The main diagram shows the hood shield being aligned with two holes on the hood, with arrows indicating the direction of the fasteners.

Carefully lower hood.

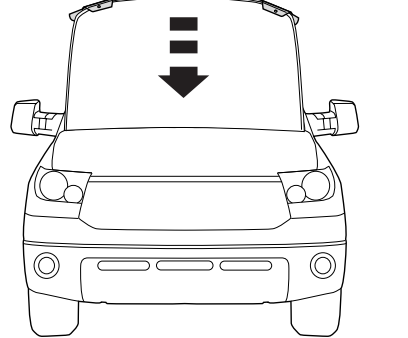

12

This panel shows the hood being lowered. A downward-pointing arrow with three horizontal bars indicates the direction of movement.

Reinstall grill by aligning with holes in hood edge. Ensure that the hood shield is **BETWEEN** the grill and the hood.

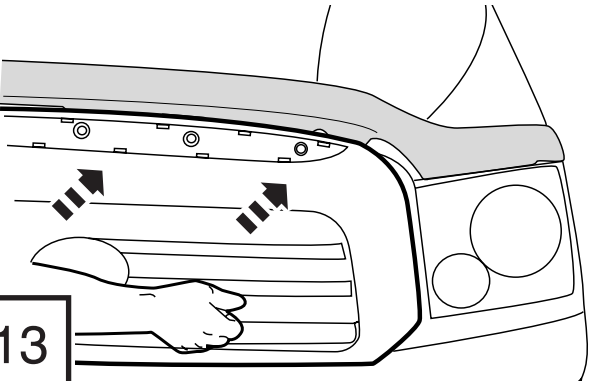

13

This panel shows the grill being reinstalled. A hand is shown pushing the grill into place, with arrows indicating the direction of movement. The hood shield is shown being pushed between the grill and the hood.

NOTE: Tundra ONLY
Reattach the grill by reinstalling (5) bolts previously removed.

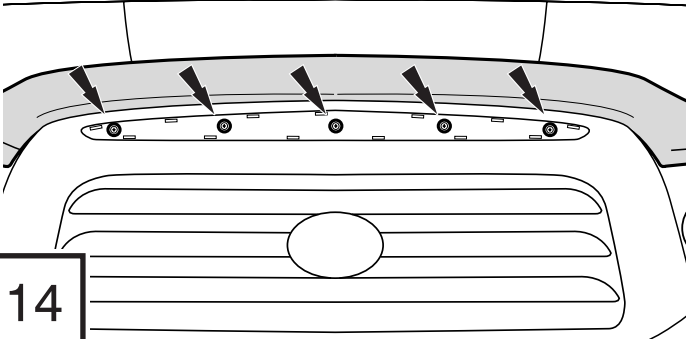

14

This panel shows the grill being reattached to the hood. Five bolts are shown being inserted into the hood edge, with arrows indicating the direction of movement.

Carefully raise hood.

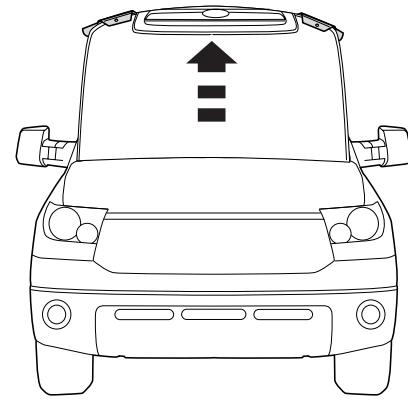

15

This panel shows the hood being raised. An upward-pointing arrow with three horizontal bars indicates the direction of movement.

Reach under the hood to the backside of the grill, and reinstall (10) nuts previously removed.

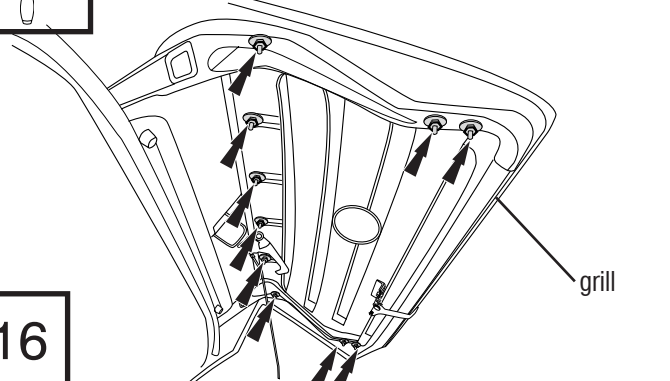

16

grill

This panel shows the grill being reattached to the hood. Ten nuts are shown being inserted into the backside of the grill, with arrows indicating the direction of movement. The word 'grill' is labeled with a line pointing to the grill.

Reach under the hood to the backside of the grill and reattach the hood lock rod to the grill.

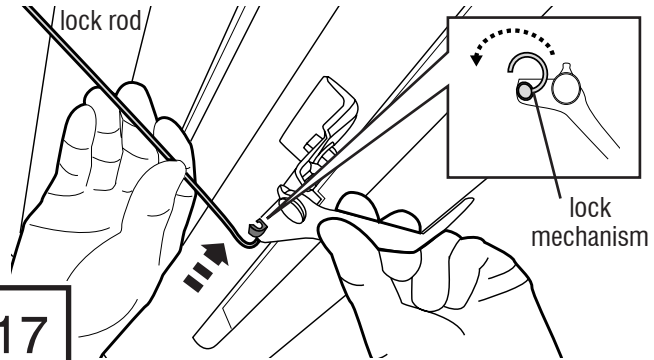

lock rod

lock mechanism

17

This panel shows the hood lock rod being reattached to the grill. A hand is shown holding the lock rod and inserting it into the lock mechanism. An inset diagram shows the lock mechanism being rotated.

Carefully close hood.

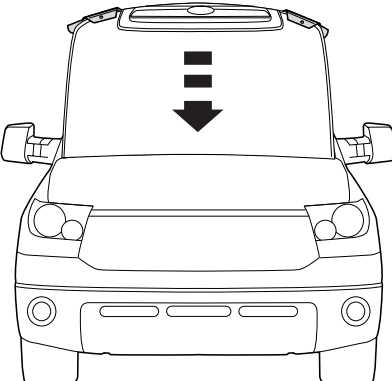

18

This panel shows the hood being closed. A downward-pointing arrow with three horizontal bars indicates the direction of movement.

Installation Steps

NOTE: Actual application may vary slightly from illustrations.

NOTE: Tundra ONLY

Carefully reinstall the previously removed applique. Slide the top clips in first, then press firmly to snap remaining tabs into place.

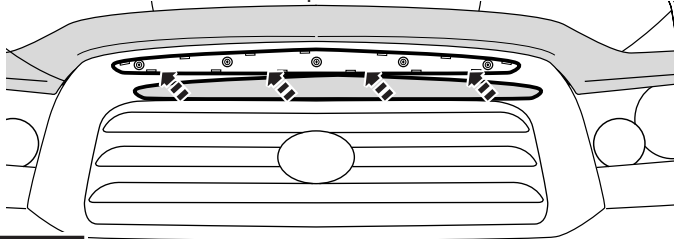

19



Apply (4) Bump ons to hood surface.

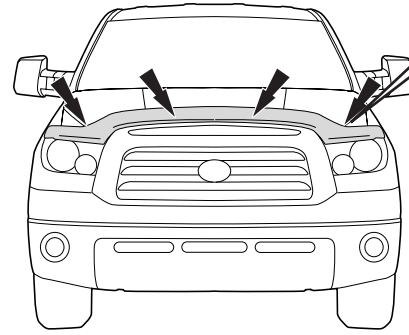

20

Care and Cleaning

- Wash only with mild soap & dry with a clean cloth.

Congratulations!

You have purchased one of the many quality Auto Ventshade™ branded products offered by Lund International, Inc. We take the utmost pride in our products and want you to enjoy years of satisfaction from your investment. We have made every effort to ensure that your product is top quality in terms of fit, durability, finish and ease of installation.



Rely on premium stone and bug deflectors by AVS if you're looking for quality and efficiency.