

# Installation Instructions



**Bugflector® - Bugflector II® - Carflector® - Chrome Hood Shield™**

## Important Safety Information



- CAUTION - Before driving, ensure that the hood shield is properly secured to vehicle.
- Do not use automatic "brush-style" car washes.
- Do not use cleaning solvents of any kind.
- Periodically check all components for tightness.

**Contents** NOTE: Actual product may vary from illustration.

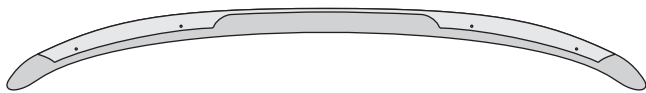

Hood Shield

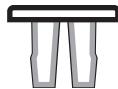

Hood Insert x4

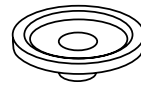

Grommet x4



Screw x4



Bump On x4

## Tools Required



Car Wash Supplies



Clean Towel

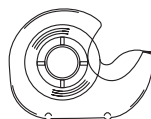

Tape

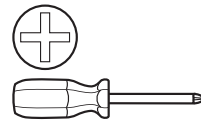

Phillips Screwdriver

## Preparation Before Painting / Installation

- A trial fit is recommended to ensure proper positioning and fit.
- Check fit of parts before painting as we will not accept the return of modified or painted parts.
- Wash your vehicle to remove any debris and/or dirt from installation area.
- Dry the installation area with a clean towel.

**Installation Steps** NOTE: Actual application may vary slightly from illustrations.

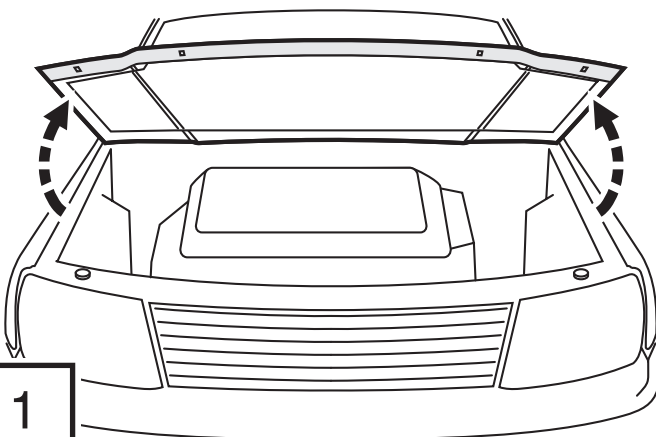

## Installation Steps

**NOTE:** Actual application may vary slightly from drawings.

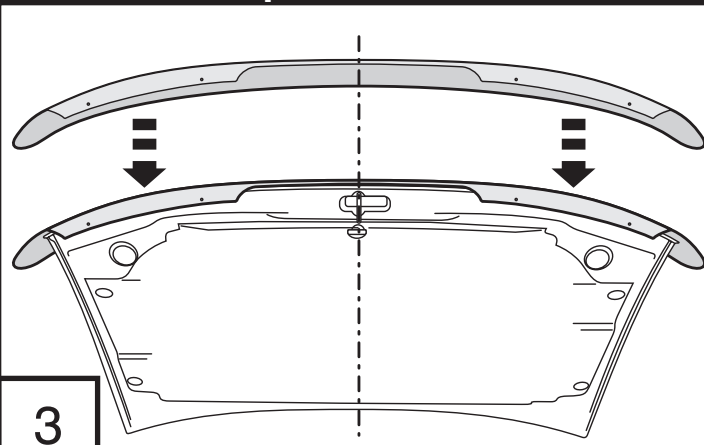

3

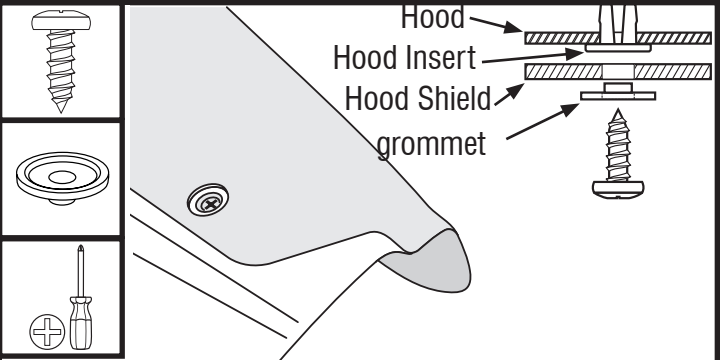

4

**NOTE:** Do No Overtighten

(X4)

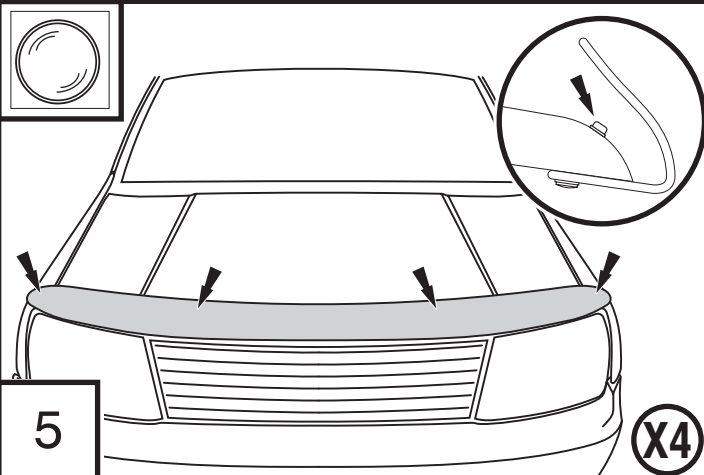

5

(X4)

## Care and Cleaning

- Wash only with mild soap & dry with a clean cloth.

## Congratulations!

You have purchased one of the many quality Auto Ventshade™ branded products offered by Lund International, Inc. We take the utmost pride in our products and want you to enjoy years of satisfaction from your investment. We have made every effort to ensure that your product is top quality in terms of fit, durability, finish and ease of installation.



Check out the collection of stone and bug deflectors we offer.