

Installation Instructions



Bugflector[®] - Bugflector II[®] - Carflector[®] - Chrome Hood Shield[™]

Important Safety Information



- CAUTION - Before driving, ensure that the hood shield is properly anchored to vehicle.
- Do not use automatic "brush-style" car washes.
- Do not use cleaning solvents of any kind.
- Periodically check all components for tightness.

Contents **NOTE:** Actual product may vary from illustration.

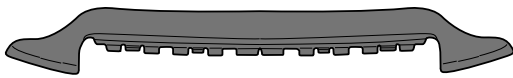

Hood Shield



Screw x2



Washer x2



Bump On x4

Tools Required



Car Wash Supplies



Clean Towel

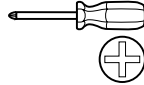

Phillips Screw
Driver

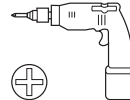

Drill



Ratchet or Wrench

Preparation Before Painting / Installation

- A trial fit is recommended to ensure proper positioning and fit.
- Check fit of parts before painting as we will not accept the return of modified or painted parts.
- Wash your vehicle's hood to remove any debris and/or dirt.
- Dry the hood with a clean towel.

Installation Steps **NOTE:** Actual application may vary slightly from illustrations.



Open hood and remove (2) 8mm hex head screws located at the bottom of the metal grille brace on either side of the grille. Retain screws for later reinstallation.

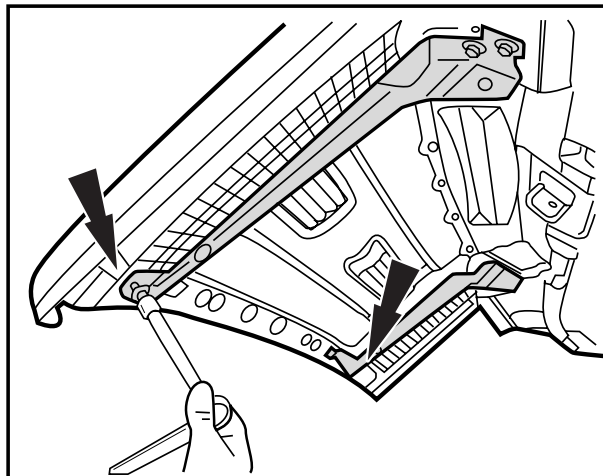

Remove 8mm hex
screws

1

Installation Steps

NOTE: Actual application may vary slightly from drawings.

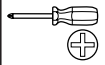

Bring hood back down to a semi-closed position. Remove (7) grille retaining fasteners with a #2 phillips screwdriver. Retain fasteners for later reinstallation.

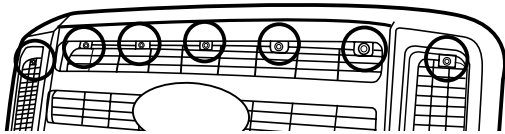
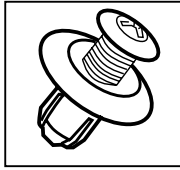

3

NOTE: It may be necessary to squeeze the back side of these retainers by hand to help the screw back out of the fastener base.

Carefully remove grille by grasping the top and bottom of one side and gently pulling upwards. This will disengage the top underside retention clips. Repeat the same procedure for the opposite side. The grille will need to be completely removed and placed carefully aside to avoid any possible damage. Clean this newly exposed area of the hood.

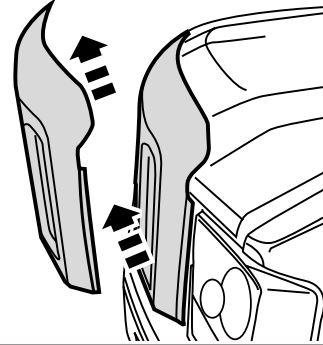

4

Remove hood shield from packaging, fit hood shield onto hood at the wing mounting tabs first and then the center. Ensure the wing tabs are located on the underside of the hood and that the center mounting tab cut outs do not block the existing hood holes. Make sure that the hood shield is centrally located on the hood.

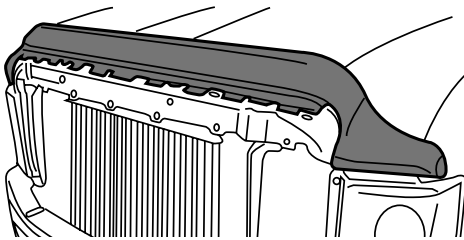
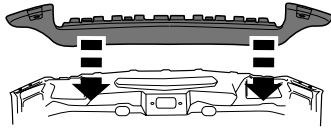

5

Re-install the grille onto the hood, making sure that the protruding mounting points on the grille line up with the receiving holes in the hood.

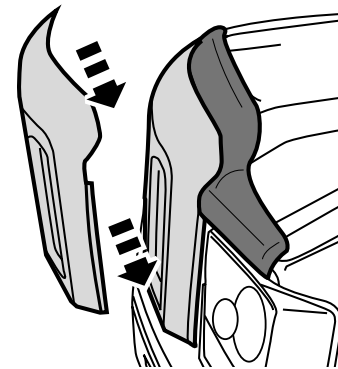

6

NOTE: the grille will not completely snap back into these mountings as the thickness of the product will now hold it off slightly.

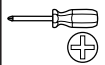

Reinstall the previously removed (7) fasteners back into the grille to ensure that it is being securely held in place.

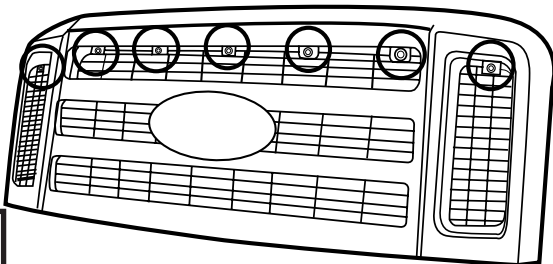
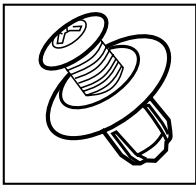

7

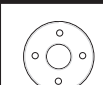
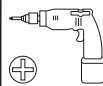

Carefully open the hood and install the screws and washers at the outer wing area tabs to secure the hood shield to the hood.

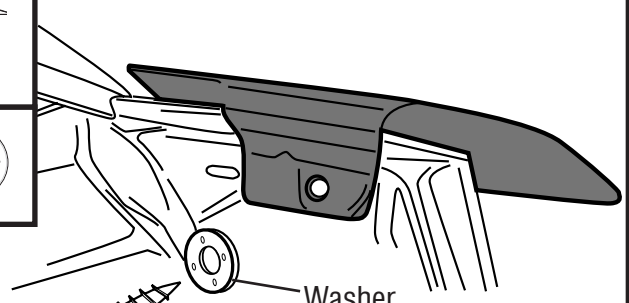

Washer

Screw

8

NOTE: Do not over tighten.

Installation Steps

NOTE: Actual application may vary slightly from drawings.



Re-install the previously removed (2) 8mm hex head screws back into the bottom of the metal grille brace on either side of the grille.
Close hood.

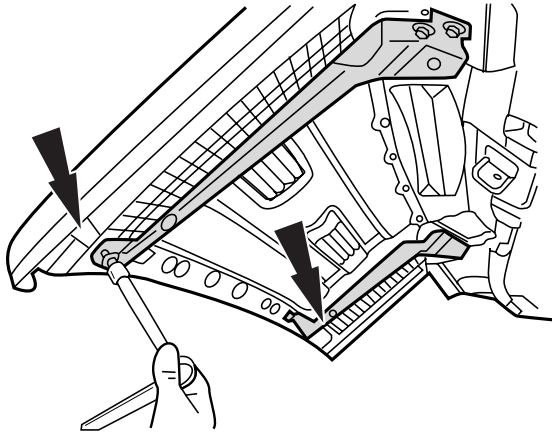

9



Install (4) bump ons.

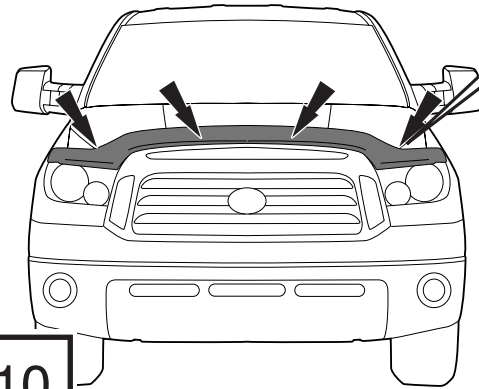

10

Care and Cleaning

- Wash only with mild soap & dry with a clean cloth.

Congratulations!

You have purchased one of the many quality Auto Ventshade™ branded products offered by Lund International, Inc. We take the utmost pride in our products and want you to enjoy years of satisfaction from your investment. We have made every effort to ensure that your product is top quality in terms of fit, durability, finish and ease of installation.



Check out the collection of stone and bug deflectors we offer.