

Installation Instructions



Headlight Covers

For proper installation and best possible fit, please read all instructions **BEFORE** you begin.

Important Safety Information



- CAUTION - Before driving, ensure that the headlight covers are properly secured to vehicle.
- Do not use automatic “brush-style” car washes.
- Do not use cleaning solvents of any kind.
- Periodically check that all components are secured.

TO CONFORM WITH FEDERAL & STATE/LOCAL LAWS, HEADLIGHT COVERS ARE INTENDED FOR SHOW, COMPETITION, AND OFF-ROAD USE ONLY.

Contents **NOTE:** Actual product may vary from illustration.

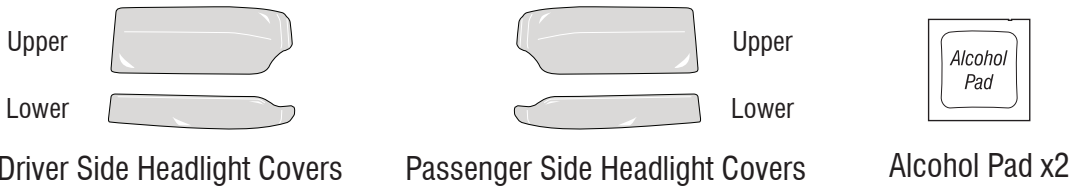

Tools Required



Car Wash Supplies

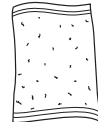

Clean Towel

Preparation Before Painting / Installation

- A trial fit is recommended to ensure proper positioning and fit.
- Check fit of parts before painting as we will not accept the return of modified or painted parts.
- Wash your vehicle’s headlight assembly to remove any debris and/or dirt.
- Dry the headlight assembly with a clean towel.

Installation Steps **NOTE:** Actual application may vary slightly from illustrations.



Clean Headlight Cover mounting location on driver side of vehicle using alcohol pad.

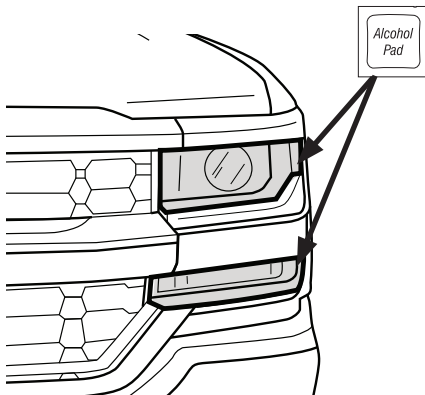

1

Remove and discard tape liners from dual-lock tabs on back side of Driver Side Upper Headlight Cover. (Number will vary based on application.)

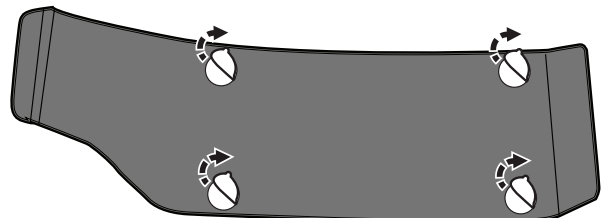

2

Installation Steps

NOTE: Actual application may vary slightly from illustrations.

Set Upper Headlight Cover in place.

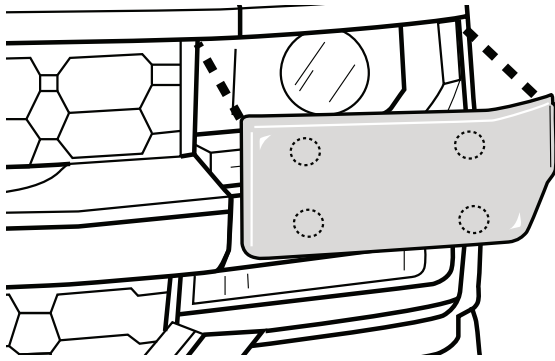

3

NOTE: The edge flange goes **BETWEEN** the headlight and the headlight trim. Use caution when inserting edge flange in place as using excessive force could damage the cover.

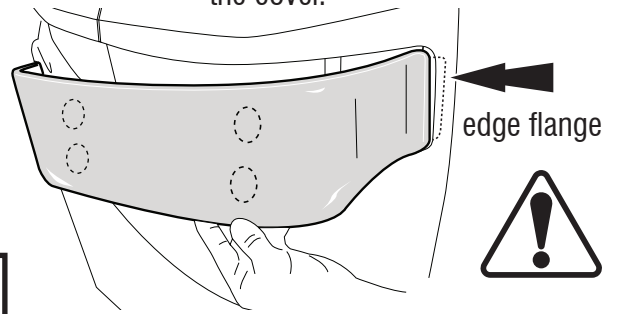

4

Apply pressure to areas of Upper Headlight Cover with dual-lock tabs to secure.

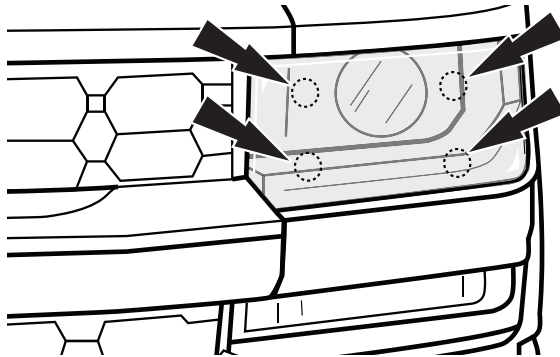

5

Repeat **Steps 2-5** to install Driver Side Lower Headlight Cover.

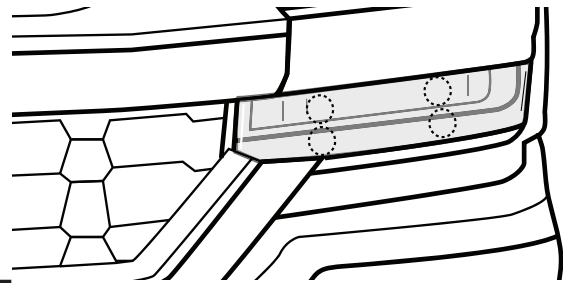

6

Repeat **Steps 1-6** for passenger side Headlight Covers.

Care and Cleaning

- Wash only with mild soap & dry with a clean cloth.

Warranty

Unconditional Lifetime Warranty: Auto Ventshade Headlight Covers are warranted to be free of manufacturer's defects. Neither seller or manufacturer shall be liable for any injury, loss or damage, direct or consequential, arising out of use of this product. User assumes all risk liability whatsoever in connection with this product.

Auto Ventshade requires the retention of these instructions for as long as you own avs headlight covers. Auto Ventshade also requires that you transfer instructions to any subsequent owner of the vehicle that uses these covers. Failure to transfer these instructions may void all warranties associated with the headlight covers.

Congratulations!

You have purchased one of the many quality Auto Ventshade™ branded products offered by Lund International, Inc. We take the utmost pride in our products and want you to enjoy years of satisfaction from your investment. We have made every effort to ensure that your product is top quality in terms of fit, durability, finish and ease of installation.



Discover other custom light covers on our website.