

# INSTALLATION INSTRUCTIONS ELECTRIC SPEEDOMETER

2650-1268-00



## General Information

This electric speedometer utilizes a LCD to display odometer and trip odometer mileage. Momentarily pressing the Trip/Reset button on the dial window cycles the odometer, trip 1, and trip 2 displays on the LCD. Pressing and holding the Trip/Reset button for more than two seconds while in either trip mode, will reset the trip odometer currently being displayed. The odometer cannot be reset.

**NOTE:** The odometer on this speedometer will show some mileage less than 5 miles (8 km). This is a result of factory testing to insure optimum quality.

### Speedometer Senders

The speedometer is designed to operate with an electrical speed sender. The speed sender signal range must be between 500 and 400,000 pulses/mile (310 and 248,500 pulses/km). Any speed sender or electronic module that meets the following two conditions can be used:

- |   |   |
|---|---|
| 1. Pulse rate generated is proportional to vehicle speed. | Recommended – Auto Meter Hall effect sender, 3-wire 16 pulses/revolution. |
| 2. Output voltage within the ranges listed below:         | 5291 Standard 7/8 – 18 thread   |
| • Hall effect sender, 3-wire (5 to 16V)                   | 5292 Ford, plug in  |
| • Sine wave generator, 2-wire (1.4 VAC min.)              | 5289 GPS Interface Module   |
| • 5V Square wave (CMOS)                                   | 5290 Universal Speed Sensor   |
|   | 3299 Optional Tach/Speedo Gauge Connector                                 |

## Mounting

1. Mount a 3<sup>3</sup>/<sub>8</sub>" speedometer in a 3<sup>3</sup>/<sub>8</sub>" dia. hole and a 5" speedometer in a 4<sup>5</sup>/<sub>8</sub>" dia. hole. Be careful not to cut the hole too large.
2. Cut a 3/8" dia. hole in the firewall for the speedometer wires. Place a rubber grommet in the hole and route the wires through the grommet to the engine compartment.
3. Connect the speedometer wires as shown in the wiring sections.
4. Secure the speedometer to the dashboard using the provided bracket and hardware.

3<sup>3</sup>/<sub>8</sub>" Models

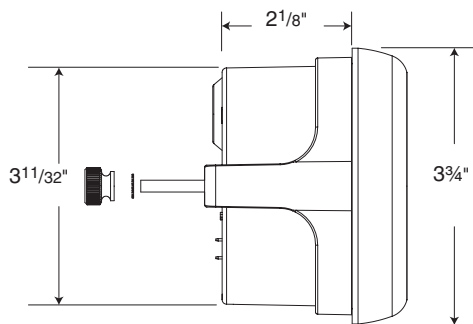

5" Models

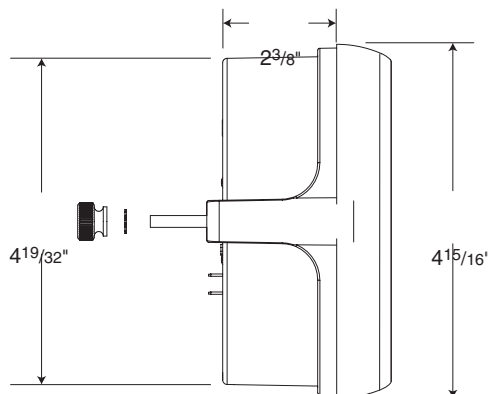

## Testing

Once the speedometer is mounted and wired into the vehicle, the speedometer should be tested to verify that the electrical connections are working properly. First, watch the speedometer's pointer as the power is applied. The pointer should first move to a midrange position, then down to the 0 position on the dial. This action verifies that power is properly connected to the speedometer. The vehicle should be driven some distance to verify the Vehicle Speed Sender (VSS) is connected properly and that the pointer moves. If the pointer does not move off of the zero position, verify that the VSS is connected properly. In some cases calibration may be needed if the pointer does not register speed. Follow the calibration procedure and retest.

## Calibration (Electric Speedometer calibration made easy!)

To calibrate your electric speedometer:

1. With the power off, push and hold the Trip/Reset button. While holding the button, start the vehicle and continue to hold the button until the pointer sweeps to full scale and stays at full scale. You may now release the button.
2. Drive to the beginning of a pre-marked 2 mile (2 kilometer) distance and stop. It does not matter how far away it is to get to this pre-marked 2 mile (2 kilometer) mile distance. DO NOT SHUT THE ENGINE OFF. Push and release the Trip/Reset button. The pointer will drop to half scale.
3. Drive the 2 mile (2 kilometer) distance. The pointer will remain at the half scale position no matter what speed you drive. It will be normal to see the LCD odometer counting rapidly as it is receiving a speed signal. If you have to stop during the calibration, that is o.k. The speedometer will simply stop counting pulses during this time.
4. At the end of the 2 mile (2 kilometer) distance, stop and press and release the Trip/Reset button. The pointer will drop to 0 and the calibration is stored. You are now finished.

Remember the accuracy of your 2 mile (2 kilometer) distance will directly affect the accuracy of your speedometer.

The following list contains factors that can affect speedometer accuracy and how to minimize them during calibration.

1. Tire diameter increases slightly as vehicle speed increases. To minimize this error drive at an average speed of 45 MPH (75 KPH) during calibration.
2. Tire diameter increases slightly as tire air pressure is increases. To minimize this error, check the vehicle's tires to ensure correct air pressure.
3. Tire diameter changes with vehicle load. Minimize this error by having an average load in the vehicle during calibration.
4. Minimize tire slippage error by not breaking traction during calibration.

**Note:** Always recalibrate speedometer after any tire size or differential ratio change.

## Wiring - Diagram 1

**NOTE:** Some models may have ground and lamp terminals on the upper row instead of lower row.

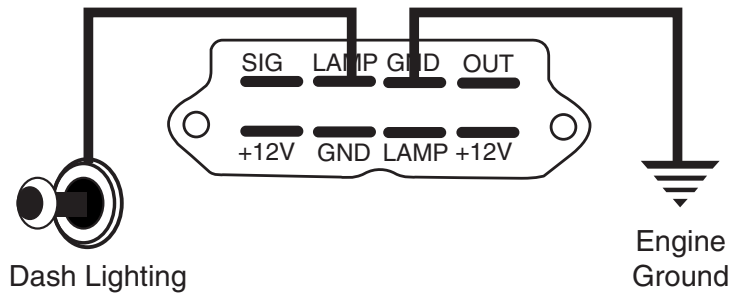

## Wiring w/ typical aftermarket 3-wire sender

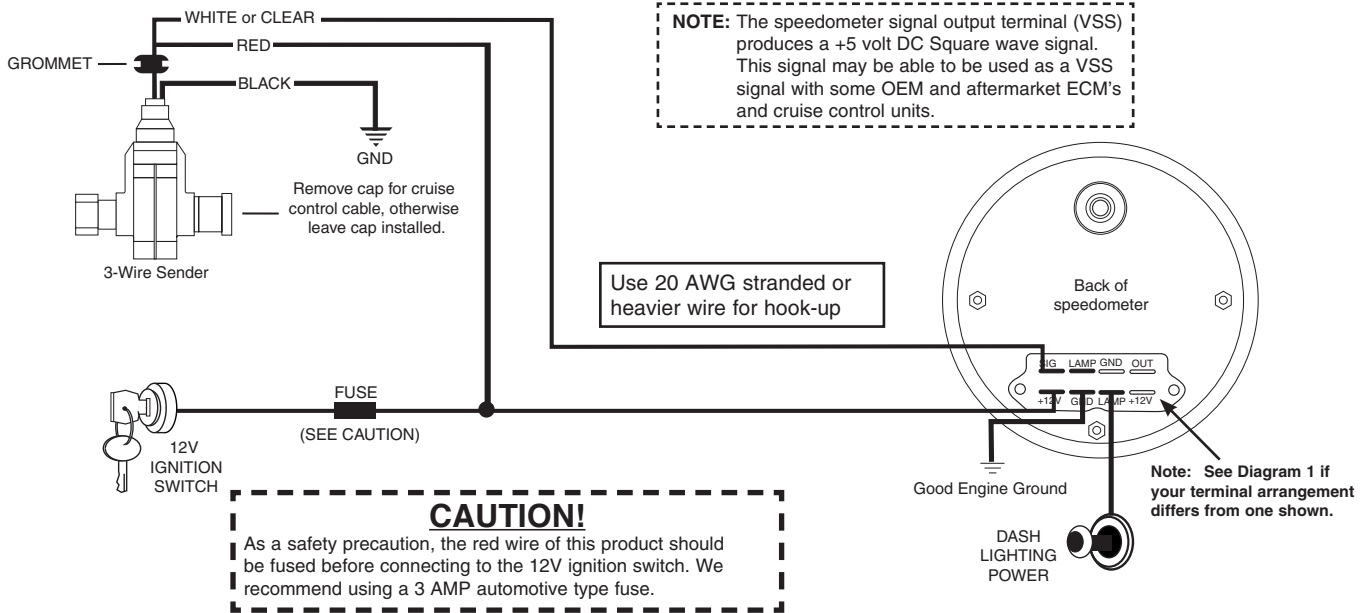

## Wiring w/ typical aftermarket 2-wire sender (and no computer)

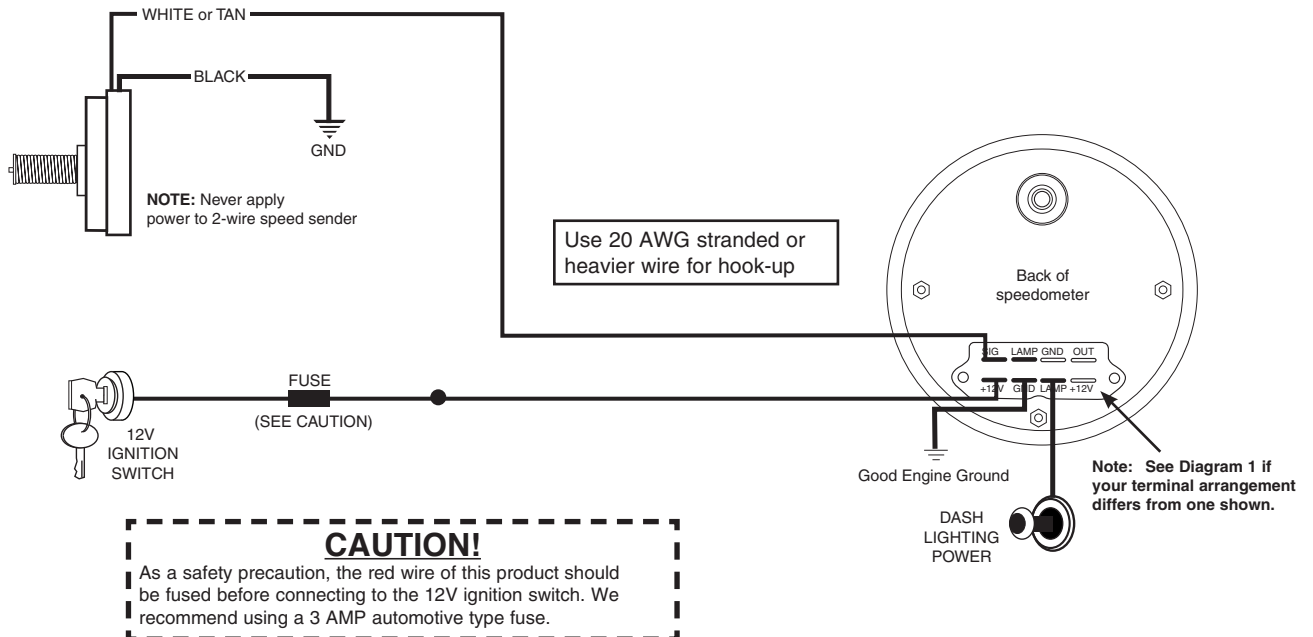

## Wiring w/ most OEM 3-wire V.S.S (Vehicle Speed Sensor)

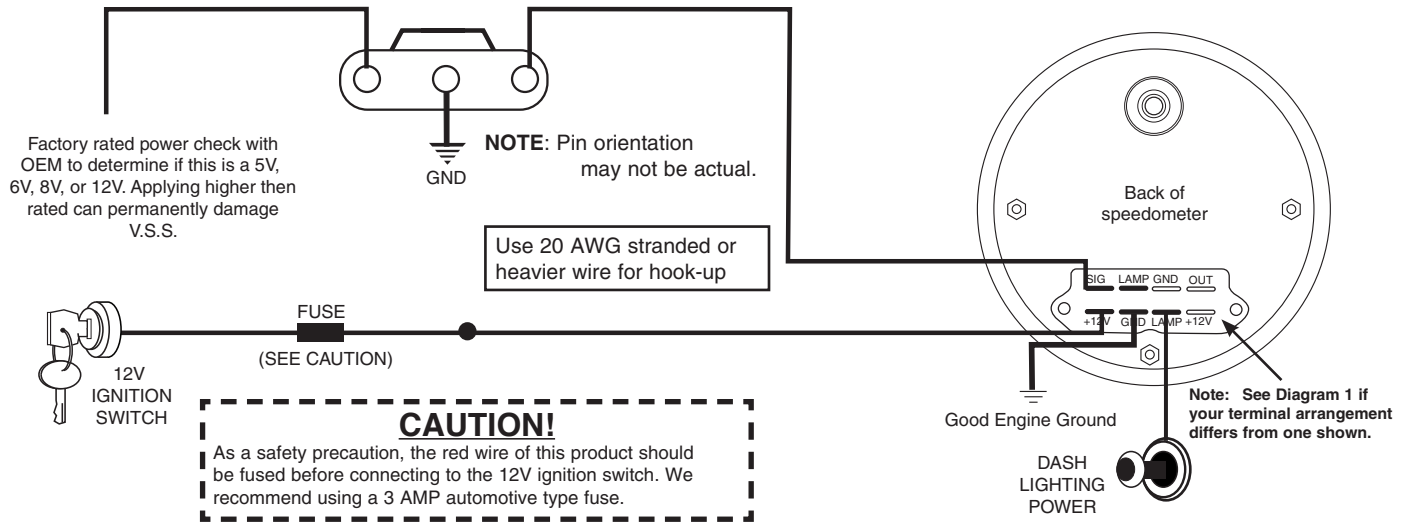

## Wiring w/ most OEM 2-wire V.S.S (When no computer involved)

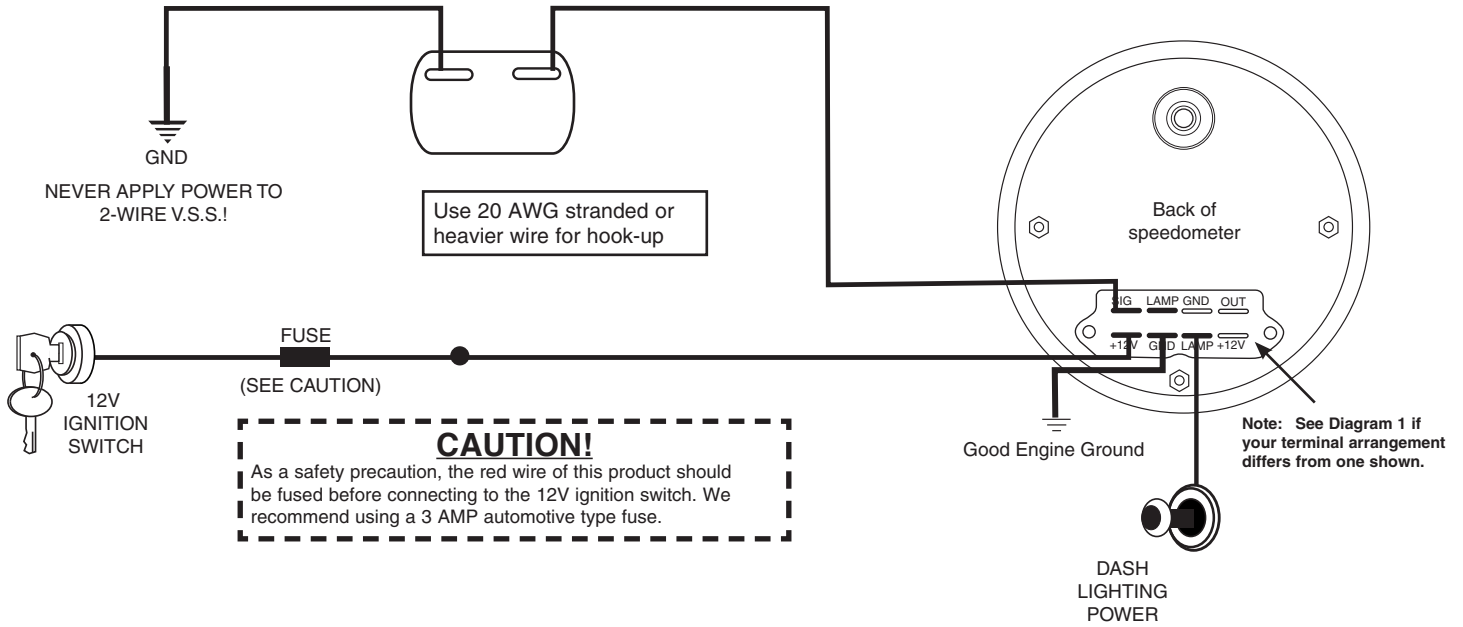

## Wiring w/ most OEM 2-wire V.S.S. when using computer or trans controller

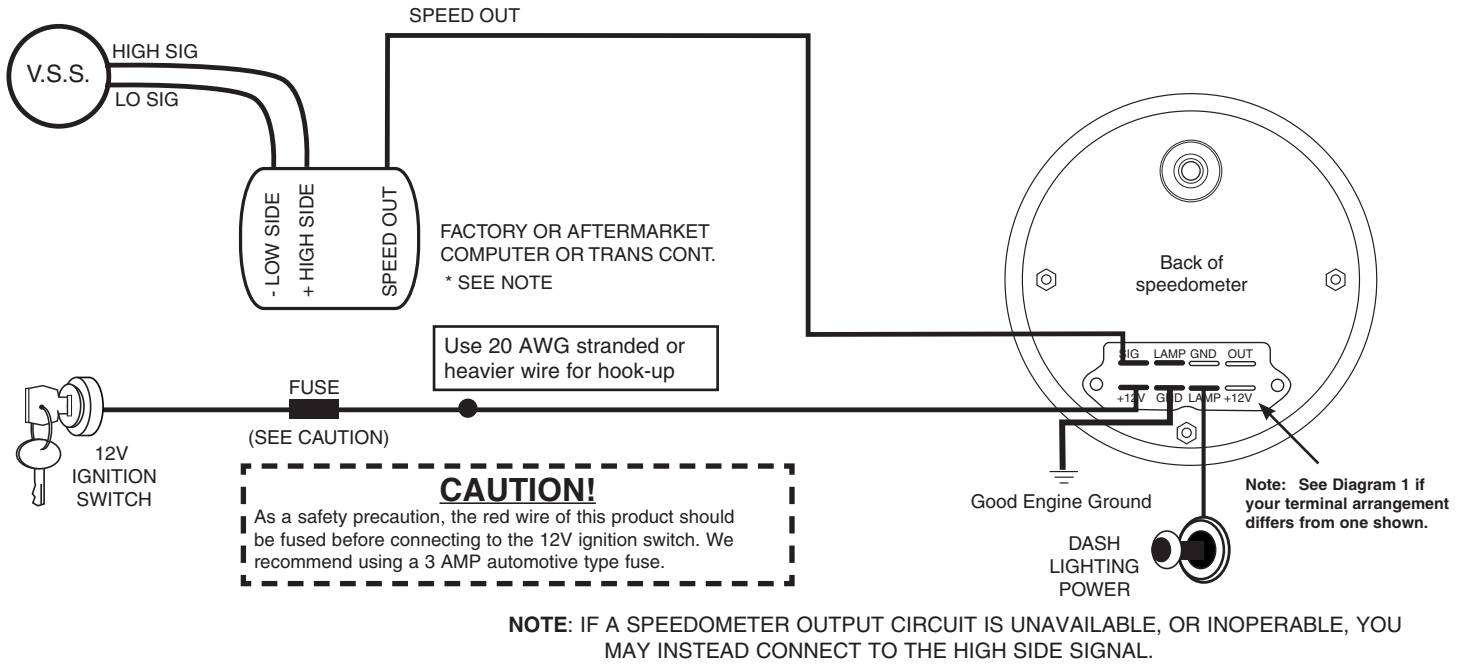

## Wiring w/ Auto Meter 5289 GPS Interface

