



With PM TEST
AGM Compatible
U.S. Patent No.
6,061,638
6,359,442
D442,503
6,771,073

VDROP is a
trademark of
Auto Meter Products



Engineered &
Manufactured by



BCT-200J Instruction Manual

**Battery Load, Charging System, Starting System and
Voltage Drop Tester for Truck Maintenance
Optional J1708 Hookup**

Complement your battery testing with complete system test including a voltage drop test that measures the voltage drop of the starting and charging circuit. The BCT-200J is automated and menu driven with simple hook-up methods for testing the negative and positive legs in one operation. Special tests are included for the magnetic switch circuit.



You have purchased one of Auto Meter's hand-held Voltage Drop Analyzers. It is designed to test each circuit of a trucks starting and charging circuit with speed and accuracy. If you should have any questions about your tester or the testing procedures please see back cover for contact information.

BCT-200J

Test Capacity	120 Amp algorithmic load
Battery sizes	200-1600 CCA
Digital Display with backlight...	1" x 2.5" - 4 line x 16 character
Volt Ranges.....	Digital 0-40V
Cooling	Vented
Load Clamps.....	4 ft., 6 Gauge
External Leads	20ft 16 Gauge
Size	6" x 9 1/2" x 1 7/8"
Memory	stores the last 80 tests
Internal Battery.....	9 Volt Alkaline
Post Adapter Kit	For group 31 batteries
<i>Optional AC-25</i>	6 pin to 9 pin J1708 Adapter
<i>Optional AC-26</i>	J1708 Cable
<i>Optional PR-15</i>	Infrared printer
<i>Optional AC24J</i>	carrying case
<i>Optional AC-10</i>	PC Interface adapter cord
<i>Optional AC-27</i>	Alternator Adapters
<i>Optional AC-35</i>	PC download program
Weight.....	4.27 lbs.

What to Expect from the BCT-200J:

Immediately recognize a bad battery. Also perform a complete voltage drop test analysis on 12 and 24 Volt systems. Load test 12 Volt batteries, load a 12 Volt alternator and do a check on a 24 Volt alternator. The BCT-200J is a portable full-featured menu-driven battery tester and voltage drop tester that provides quick, professional load results using Auto Meter's advanced algorithmic load. The BCT-200J has the option of using a J1708 cable. It is professionally accurate and detailed test results are LCD displayed after each test and can be reviewed and printed from memory.

CAUTION: The BCT-200J grill may get hot after repeated use. Be sure to hold the unit from the side grips only. Keep hands away from the grill.

Remy Intelli-Check II™ Charging System Test

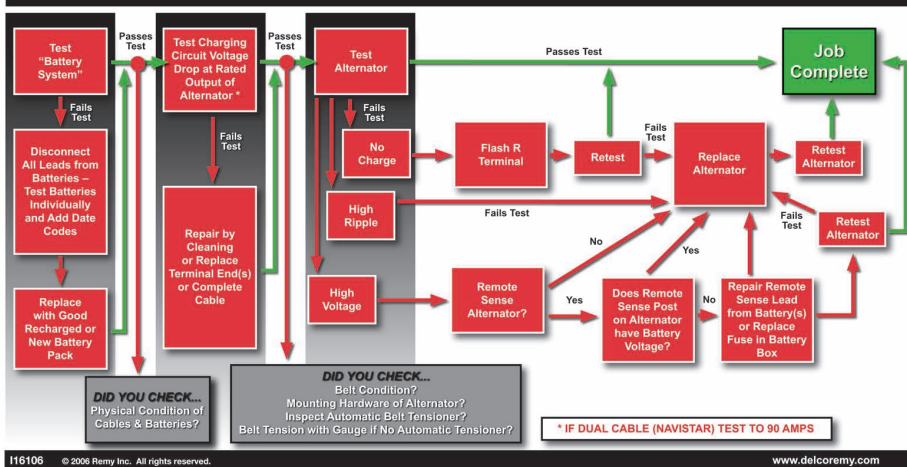

H16106 © 2006 Remy Inc. All rights reserved. www.delcoremy.com

Remy Intelli-Check II™ Cranking System Test

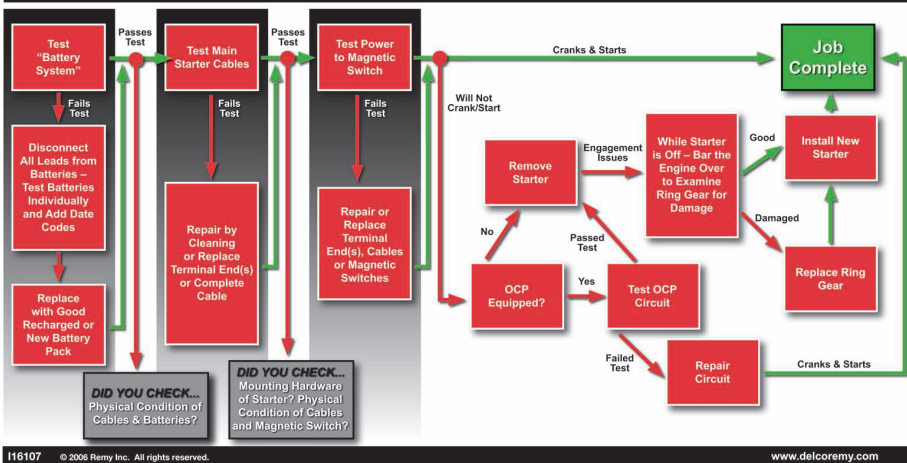

I16107 © 2006 Remy Inc. All rights reserved. www.delcoremy.com

TABLE OF CONTENTS

Specifications	2
Safety	4
Cause of Battery Failure	4
Inspection and Visual Check	5
Controls and Functions	6

Test Sections

1. PM Test	7
2. Battery Bank Test	8-9
3. Individual Battery Test	10-12
4. Charging Cable VDrop Test	13-15
* Single	
* Dual	
5. Alternator Output Test	16-23
* Standard	
* Remote Sense	
6. Main Starting Cable VDrop Test	24-29
* Single	
* Split	
7. Magnetic Circuit VDrop Test	30-32
* Without IMS	
* With IMS	
8. Key Circuit VDrop Test	33-36
* Without OCP	
* With OCP	
9. Liftgate VDrop Tests	37-39
10. Alternator Bench Test	40-45

Maintenance	46
Clamp Replacement	46
Battery Replacement	46

Other Menu Options	
Review Tests	47
(Optional) Printer	47
Printing Test Results	48
Volt Meter	48
J1708 Data	48
Setup	50-51
PC Download Interface	46
Using Windows	47
Downloading Test Information	48
Capturing Text in Microsoft Excel	49
About	56
Warranty Information	57
Chart	58

SAFETY

- Carefully read all operating instructions before operating the BCT-200J
- Wear eye protection when working on batteries.
- Be sure each test is complete before removing load clamps to prevent arcing and potential explosion from battery gases. Never remove load clamps while testing. Keep sparks, flames or cigarettes away from battery.
- Keep hair, hands, and clothing as well as tester leads and cords away from moving blades and belt.
- Provide adequate ventilation to remove exhaust.
- In extremely cold temperatures check for frozen electrolyte fluid or swelled case before applying load. Do not attempt to Load Test or charge a battery under 20° F. (-7°C.). Allow the battery to warm to room temperature before testing or charging.
- **Warning!** BCT-200J can only be attached to a Delco Remy Bench Tester and used in prescribed manner. It should never be attached to any other tester or charging unit. Damage may result.

**Wear
Safety
Glasses**



WARNING!

TESTING OF HYBRID VEHICLES

DO NOT test the starter, alternator and/or 12 volt starting battery while it is in the vehicle.

DO NOT remove, service or test the hybrid battery pack under any circumstances.

Remove the 12 volt starting battery, starter or alternator from the vehicle prior to testing.

CAUSE OF BATTERY FAILURE

- **Incorrect Application:** Wrong size battery may have inadequate cold cranking rating for original vehicle specifications.
- **Incorrect Installation:** Loose battery hold-downs cause excessive vibration, which can result in damage to the plates.
- **Improper Maintenance:** Low electrolytic fluid and corrosion on battery connections can greatly reduce battery life and effect battery performance.
- **Internal Connections:** Make sure internal connections of entire charging system meet proper specifications.
- **Age of Battery:** If the date code on the battery is old, test failure may indicate the need of replacement.
- **Overcharging:** Overcharging caused by a high voltage regulator setting or incorrect battery charging can cause excessive gas, heat and water loss.
- **Undercharging:** Undercharging caused by a faulty charging system or low voltage regulator setting can cause lead sulfate to gradually build up and crystallize on the plates, greatly reducing the battery's capacity and ability to be recharged.
- **Cycling:** Excessive drain on battery when alternator is not operating.

LIMITED WARRANTY

1 YEAR FROM DATE OF PURCHASE CABLES 90 DAYS

The manufacturer warrants to the consumer that this product will be free from defects in material or workmanship for a period of one (1) year from the date of original purchase (90 Days for cables).

Products that fail within this 1 year warranty period will be repaired or replaced at the manufacturer's option to the consumer when determined by the manufacturer that the product failed due to defects in material or workmanship. This warranty is limited to the repair or replacement of parts the necessary labor by the manufacturer to effect the repair or replacement of the product. In no event shall the manufacturer be responsible for special, incidental or consequential damages or costs incurred due to the failure of this product.

Improper use, accident, water damage, abuse, unauthorized repairs or alterations voids this warranty. The manufacturer disclaims any liability or consequential damages due to breach of any written or implied warranty on its test equipment.

WARRANTY AND SERVICE INFORMATION

Warranty claims to the manufacturer's service department must be transportation prepaid accompanied with dated proof of purchase. This warranty applies only to the original purchaser is non-transferable. Shipper damage incurred during return shipments is not covered under this warranty. It is the responsibility of the shipper (the customer returning the Test Equipment) to package the tester properly to prevent any damage during return shipment. Repair costs for such damages will be charged back to shipper (customer returning the Test Equipment). Protect the product by shipping in the original carton. Add plenty of over-pack cushioning such as crumpled up newspaper.

Remy Intelli-Check II™ Key Components

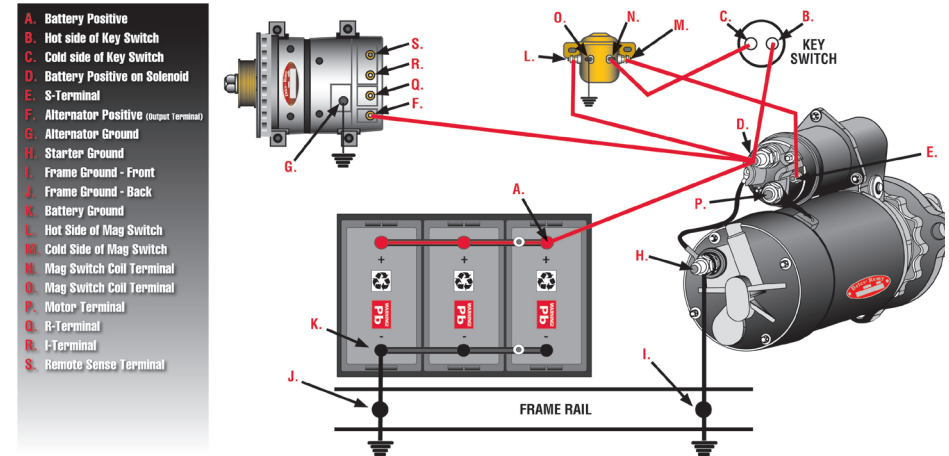

116108 © 2006 Remy Inc. All rights reserved.

www.delcoremy.com

ABOUT

```
J1708      ↑
SETUP
DOWNLOAD
>ABOUT
```

```
INTELLI-CHECK2J
VERSION 4.12
DATE 05/16/2013
COPYRIGHT 1999
```

Gives the version of the software.

NOTE: This screen is for reference only. The software version and date shown in the screen illustration may not match what is displayed on the actual tester.

The program can be updated to the most recent version by reflashing the memory. Before turning the unit on hold the (N Exc.) and the (Y Enter) key down simultaneously. The following will appear.

```
READY (U2.00)
```

```
REFLASHING!
```

When a computer can be attached to the unit in the same way the test data can be downloaded. "REFLASHING!" will then appear.

The software will be available from a CD or can be downloaded from our website. Contact Auto Meter for more information.

INSPECTION

Valid automotive electrical system testing depends on all the components being in good operating condition. In addition, the battery **MUST** have sufficient charge for testing. Carefully perform the following before attempting electrical diagnosis.

VISUAL CHECK

- **Inspect Battery** for terminal corrosion, loose broken posts, cracks in the case, loose hold-downs, low electrolyte level, moisture, and dirt around the terminal.

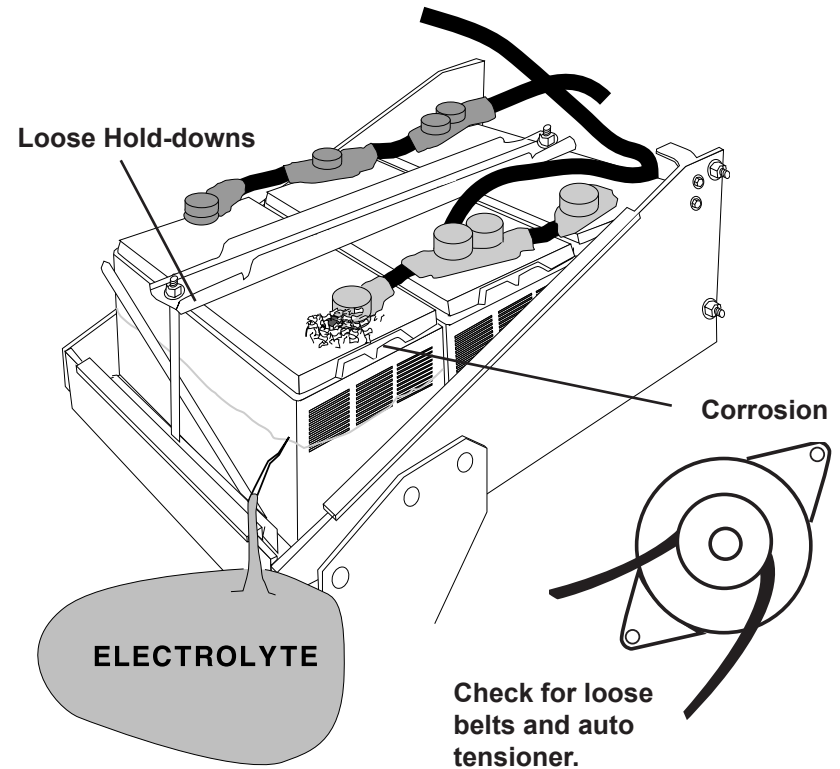

- **Important Note:** **A known defective battery must be replaced before proceeding with any test on the charging or starting system.**
- **Inspect Belts** for cracks, glazed surface and fraying. Tighten loose belts. Inspect auto-tensioner for proper belt tension.
- **Inspect Starting System.** Check starter, solenoid, and alternator for loose connections, loose mounts and frayed or cracked wires.

CONTROLS AND FUNCTIONS

LCD:

Displays menus and test results.

KEYS:

When each key is pressed, a beep sounds to assure contact has been made.

On/Off Key:

This is the manual on/off key.

Y Enter Key:

This key selects the next menu, the cursor line item and answers 'yes' to a test progression.

+Up Key:

This key moves the cursor up in order to select a menu line item. It also increments a value.

-Down Arrow Key:

This key moves the cursor down in order to select a menu line. It also decrements a value.

N Esc Key:

This key cancels a test or progression. It also returns to the previous menu.

Print Key:

When the BCT-200J is pointed toward or at the optional PR-15 printer, pressing the print key will cause the test results to be printed.

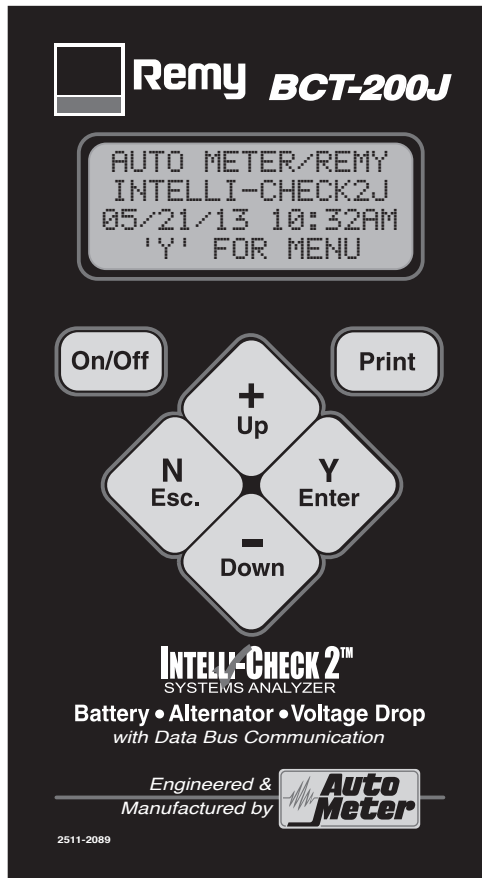

J1708 and PC Download Jack:
Adapter cord inserts here.

Infrared Print Light:

Data is sent to the infrared printer when the print button is pressed.

Retractable Hanging Hook:

Hang unit at various points to free hands for clamp attachment.

CAPTURING TEXT

5. Using Microsoft Excel

Note: For other software applications consult your software manual.

- Make sure menu is displayed as shown in illustration page 20 step 3.
- Select "Capture Text" in the Transfer Menu.
- Type in **c:\my documents\download.txt** and then select "Start."
- Press "1" to download. When finished select Capture Text again from the Transfer Menu then select Stop.
- Launch Microsoft Excel and select open file.
- Under "Files of Type" at the bottom of the open file window select All Files (*.*)
- Highlight your "**download.txt**" file then select Open.
- Select "Delimited" and start at row 1 then "Next"
- Select "Comma" then "Next"

	A	B	C	D	E	F	G	H	I	J	K	L	M	N	O	P
53																
54																
55																
56																
57	--- Download Data ---															
58																
59	6V Battery Tests 4															
60	12V Battery Tests 51															
61	24V Battery Tests 1															
62	12V Alt. Tests 21															
63	24V Alt. Tests 0															
64	12V Starter Tests 11															
65	24V Starter Tests 0															
66	Total Prints 11															
67	85	12V Batte	12.8	9.3	200	180	70	1								
68	87	12V Batte	12.86	0	0	170	70	5								
69	86	12V Batte	12.56	10.96	550	640	70	1								
70	85	12V Batte	12.74	10.96	1000	560	70	0								
71	84	12V Batte	12.77	0	0	860	30	5								
72	83	12V Batte	12.77	0	0	700	30	5								
73	82	12V Batte	0	0	0	3660	30	4								
74	81	12V Alter	14.52	13.86	1118	0	0	99								

- Under Column Date Format select "General" then "Finish"
- After the file is loaded you can delete unwanted rows and format columns as desired. The following are labels for identifying the 8 columns of information.

BCT-200J Test Labels

Date Code	N/A	N/A	N/A	N/A	N/A	Condition	Tech ID	Vehicle ID	VIN	Time/Date
Date Code	N/A	N/A	N/A	N/A	N/A	Condition	Tech ID	Vehicle ID	VIN	Time/Date
Date Code	N/A	N/A	N/A	N/A	N/A	Condition	Tech ID	Vehicle ID	VIN	Time/Date
Engine Speed	R-Term	Engine Speed	N/A	N/A	Code	N/A	Tech ID	Vehicle ID	VIN	Time/Date
Engine Speed	R-Term	Engine Speed	N/A	N/A	Code	N/A	Tech ID	Vehicle ID	VIN	Time/Date
Oil Temp	Amb. Temp	N/A	N/A	N/A	Code	N/A	Tech ID	Vehicle ID	VIN	Time/Date
Oil Temp	Amb. Temp	N/A	N/A	N/A	Code	N/A	Tech ID	Vehicle ID	VIN	Time/Date

1 PM TEST

4. PC Screen Menu

- If the BCT-200J is properly connected to your PC and the LCD shows "CONNECT ANALYZER TO A PC" the menu should automatically be displayed in Hyper Terminal.
- Press "1" to download the stored data.

To save the information displayed see "Capture text into Microsoft Excel." See BCT-200J test labels below for identification.

- Press "Enter" to return to Menu.
- Press "Enter" to return to Menu.
- Press "3" to Exit.

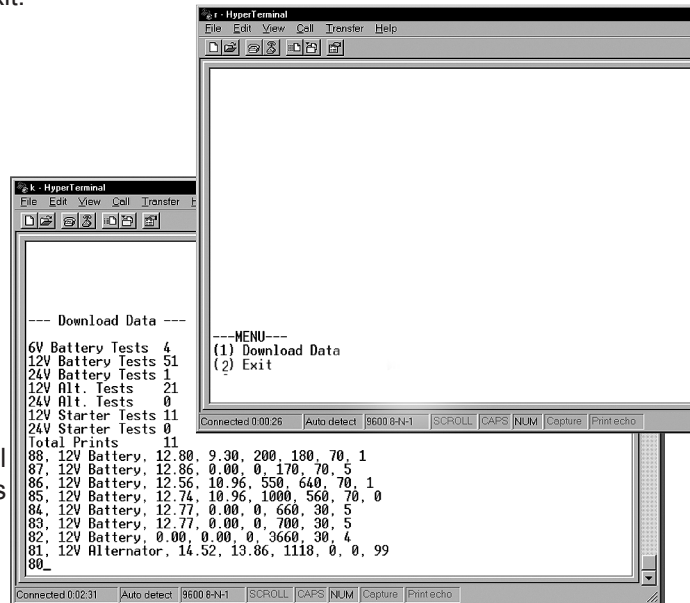

HyperTerminal Windows

BCT-200J Test Labels

Battery Bank	Beginning Volts	Loaded Volts	Rated CCA	# of Batteries	Temperature	N/A	Amb. Temp
12V Battery	Beginning Volts	Loaded Volts	Rated CCA	Est. CCA	Temperature	1ST CCA	Amb. Temp
24V Battery	Beginning Volts	N/A	N/A	N/A	Temperature	N/A	Amb. Temp
12V Alter.	Beginning Volts	Loaded Volts	mVAC	Peak Volts	mVAC	Rated Current	R-Term
24V Alter.	Beginning Volts	Loaded Volts	mVAC	Peak Volts	N/A	Rated Current	R-Term
12V Starter	Beginning Volts	Loaded Volts	Ext Volts	Pos Drop	Cranking Volts	Pos Drop	Draw

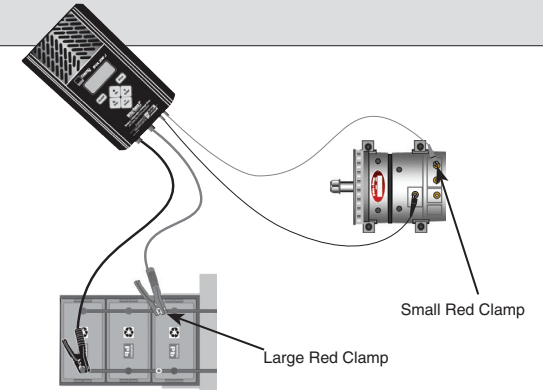

The PM Test should only be used during a time when the vehicle is in the shop for a PM Service, NOT when the vehicle is having electrical system issues. For a vehicle with a suspected electrical problem use the individual tests starting with the batteries, then the cables, and finally the alternator or starter.

- AUTOMETER/REMY INTELLI-CHECK2J 05/21/13 'Y' FOR MENU
- >PM TEST BATTERY TEST BATTERY BANK V DROP MENU
- >ENTER NUMBER OF BATTERIES: 4 USE +/- 'Y' TO CONTINUE
- >CONNECT LARGE LEADS TO THE BATTERY BANK 'Y' TO CONTINUE
- >BANK MUST BE STABILIZED FOR VALID RESULTS 'Y' TO CONTINUE
- >ENTER BATTERY TEMP: 40F 12.89 V 'Y' TO CONTINUE
- >ENTER BATT TYPE AGM USE +/- 12.89 V 'Y' TO CONTINUE
- >ENTER SINGLE CCA: 700 12.89 V 'Y' TO CONTINUE
- TESTING BANK PLEASE WAIT
- LOAD BATTERY PLEASE WAIT
- >START ENGINE AND THEN REV TO GOVERNED SPEED 'N' TO CANCEL
- TESTING STARTER PLEASE WAIT
- TESTING ALT. PLEASE WAIT
- TESTING ALT. AT GOVERNED SPEED 14.12 V
- >SET IDLE AT ABOUT 1000 R.P.M. 'Y' TO CONTINUE
- TESTING ALT. PLEASE WAIT
- #13 PM CHECK BATTERIES: PASS STARTING: PASS CHARGING: PASS
- #13 PM TEST GOOD BATTERIES 12.89 V CHRG 100%
- #13 PM TEST CRANK V: 10.91 V CRANK A: 570A VDROPA500A: 0.41
- #13 PM TEST GOOD REG: 14.09 V RIPPLE: 2.70M V

2

BATTERY BANK TEST

NOTE: When performing a PM Test the tester will automatically run the Battery Bank Test to make sure that the battery bank passes. Therefore, you need only use the Battery Bank Test for testing the battery bank only. The Battery Bank Test is designed for preventative maintenance only. If there is an electrical problem you should test each battery individually.

```
>ENTER NUMBER OF
  BATTERIES: 3
  USE +/-
  'Y' TO CONTINUE
```

You will be asked to enter the number of batteries in the system. The number selected in the last test will appear. Simply use the (+) or (-) key to select the correct number. Then press ('Y' Enter) to continue.

```
>INSPECT BANK FOR
  DIRT, LEAKS OR
  CRACKS.
  'Y' TO CONTINUE
```

```
>INSPECT POSTS
  AND CONNECTIONS
  'Y' TO CONTINUE
```

Always check batteries, battery posts and connections before testing the batteries. If the batteries or posts are damaged replace the batteries. Make sure the batteries are free from dirt, cracks and leaks and that the connections are clean and secure.

USING WINDOWS 98/2000/NT/XP

Note: The BCT-200J will interface with any basic (ANSI) terminal emulation software. Most operating systems contain a program that will do this. Following are instructions for Windows. For other operating systems consult the Manual for that system.

3. Opening Windows HyperTerminal:

- Select Windows Start
- Then "Programs"
- Then "Accessories"
- Then "Communications"
- Then Click "Hyper-Terminal"
- Double Click "Hypetrm.exe" application
- Type in a name for your connection
- Select an icon for future identification
- Select "OK"
- Select the COM port number you have previously identified in step 1.
- Select "OK" and select the following from the pull down menus:

Bits per second	9600
Data bits	8
Parity	None
Stop Bits	1
Flow Control	None
- Select "OK"

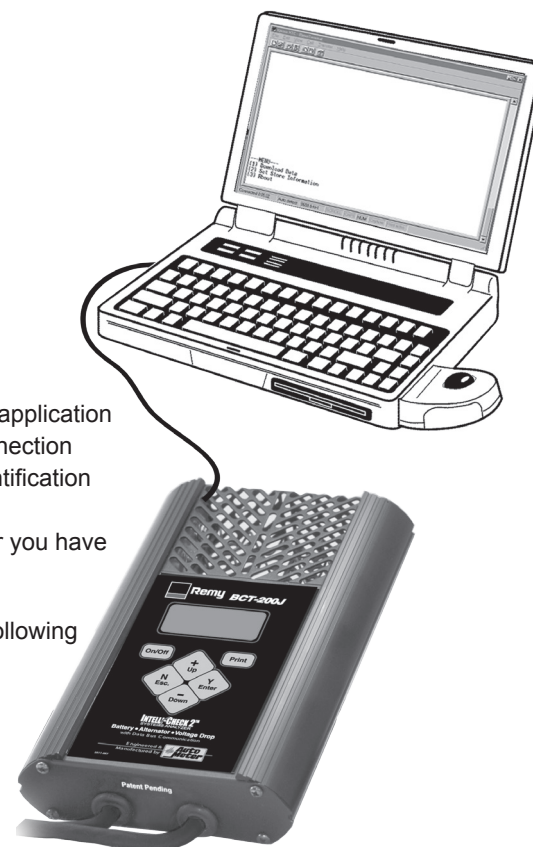

PC INTERFACE

1. Scroll down the main menu to DOWNLOAD. Press (Y Enter) to select.

```
VOLT METER
J1708 DATA
SETUP
>DOWNLOAD
```

Using Auto Meter's optional adapter cord AC-10 insert the plug into the jack on the BCT-200J (see page 6) and then plug the serial adapter into a free serial port on your computer.

```
CONNECT ANALYZER
TO A P.C.
9600, N, 8, 1.
'N' TO CANCEL.
```

Note: Most computers are configured with at least one serial port (identified as COM 1), and some have a second serial port, usually identified as (COM 2). Check your computer manual to locate and identify a serial port connector. Even if you have a physical COM port you need to make sure it is working properly before you proceed. Consult your computer manual. If your computer serial port is configured for 25 pin you will need to obtain an adapter from your computer store. If your computer does not have an available serial port and you're planning on using *Windows HYPER Terminal* as illustrated below, you will need to buy and install an adapter card with a serial port.

2. Using Auto Meter's AC-35 Application Program
By purchasing Auto Meter's PC Application Program, information that is stored and collected in the BCT 200J can be easily downloaded into a PC program format for storage. The AC-35 comes with a PC cable, installation and user instructions.

BATTERY BANK (Cont.)

```
>CONNECT LARGE
LEADS TO THE
BATTERY BANK
'Y' TO CONTINUE
```

You will be instructed to connect the large leads. Connect the red clamp to the main positive cable coming to the bank and the black clamp to the main negative cable leaving the bank.

```
>BANK MUST BE
STABILIZED FOR
VALID RESULTS
'Y' TO CONTINUE
```

For the most accurate and repeatable tests always allow the batteries to stabilize for at least 10 minutes after being charged or loaded before running a test.

Black Clamp at Negative Main

Red Clamp at Positive Main

Connect large alligator clips as far apart as possible.



Battery Bank of 3 Batteries

Using the (+) or (-) key adjust the temperature in units of 10 degrees. This should be the temperature of the battery(S). Consider where the vehicle has been before adjusting.

```
>ENTER BATTERY
TEMP. 70F.
12.39V
'Y' TO CONTINUE
```

Use the (+) or (-) key to select the battery type, either AGM or regular lead-acid.

```
>ENTER BATT TYPE
AGM USE +/-
12.39V
'Y' TO CONTINUE
```

Using the (+) or (-) key adjust the CCA of an individual battery. If each battery varies in CCA approximate an average. If the CCA is unknown consider that most truck batteries range from 625-950 CCA.

```
>ENTER SINGLE
CCA 650
12.39V
'Y' TO BEGIN
```

Press (Y Enter) to begin the test and wait for results. Example is at the top of page 10 (Individual Battery Test).

```
TESTING BANK
PLEASE WAIT...
```

3

INDIVIDUAL BATTERY TEST

SETUP (Cont.)

```
#211 12V BANK
GOOD BATTERIES
12.70V CHRGR 100%
11.50V LOADED
```

When the test results appear as **GOOD BATTERIES** after running the PM Check or Battery Bank Test there is no need to run the individual battery tests. Press (N Esc.) to return to the menu

```
#211 12V BANK
TEST SEPARATELY
12.38V CHRGR 66%
```

If the battery bank test results are low you will be instructed to test each battery separately. Press (Y Enter) to continue.

```
PM TEST
>BATTERY TEST
BATTERY BANK
VDROP TEST
```

Select **BATTERY TEST** from the main menu.

```
>INSPECT BATTERY
FOR DIRT, LEAKS
OR CRACKS
'Y' TO CONTINUE
```

Always check for dirt and cracks or leaks in the battery.

```
>INSPECT POSTS
AND CONNECTIONS
'Y' TO CONTINUE
```

IMPORTANT

Poor connections may be the reason for battery bank failure. Clean posts and connections are essential when checking each battery. Make sure batteries not being tested are disconnected.

Note! When testing batteries individually each battery should be disconnected. Avoid improper results and damage to the posts by using the included post adapters on threaded post batteries.

```
>CONNECT LARGE
LEADS TO THE
BATTERY.
'Y' TO CONTINUE
```

Connect the large red clamp to the positive and the large black to the negative battery terminal. If the clamps are connected improperly you will be prompted to correct the problem. The tester will then revert back to the beginning or main menu. Be sure to use post adapters on threaded steel posts as illustrated on the next page then press (Y Enter).

```
>REQUIRE BATTERY
SERIAL #? NO
USE +/-,
'Y' TO SELECT.
```

To require a battery serial number before each battery test select **YES**. If **YES** is selected then before each battery test the tester will prompt for a 14 digit alphanumeric serial number. This serial number will be printed near the bottom of the printout along with the warranty code.

```
>CHANGE THE TIME
01/31/03 10:12AM
'N' OR 'Y'
```

If you select **Yes** you can change the **MONTH, DAY, YEAR, HOUR** and **MINUTE**.

```
>SET MONTH:01
USE +/-,
'Y' TO CONTINUE
```

Select the month as 01 to 12

```
>SET DAY:02
USE +/-,
'Y' TO CONTINUE
```

Select the day as 01 to 31

```
>SET YEAR:03
USE +/-,
'Y' TO CONTINUE
```

Select the year as 04 to 99

```
>SET HOUR:10 AM
USE +/-,
'Y' TO CONTINUE
```

Select the hour as 01 to 12 AM/PM

```
>SET MINUTE:12
USE +/-,
'Y' TO CONTINUE
```

Select the minute as 01 to 60

```
>DELETE STORED
DATA
USE +/-,
'N' OR 'Y'
```

Can delete all test data or one item at a time.

SETUP

INDIVIDUAL BATTERY TEST (Cont.)

```
REVIEW/PRINT
VOLT METER
J1708 DATA
>SETUP
```

From the main menu select SETUP.

```
>SET TEMPERATURE
SCALE: F.
USE +/- .
'Y' TO SELECT
```

Select the temperature in Fahrenheit or Centigrade.

```
>REQUIRE VEHICLE
ID NUMBERS? YES
USE +/- .
'Y' TO SELECT
```

```
>ENTER VEHICLE
ID# 0000
USE +/- .
'Y' TO CONTINUE
```

You can require the entry of a vehicle identification number for each test. Use the (+) or (-) key to change the displayed request.

If answered YES the above screen will appear at the beginning of the first test for a vehicle. Each digit, with a total of 6, requires increment or decrement to the desired number. The requested digit to change is flashing. By pressing (Y Enter) the next digit is selected. On the last enter the displayed number will be accepted and remain in memory.

Note: The ID number will not be requested again as long as the unit is not turned off.

```
>REQUIRE TECH.
NUMBERS? NO
USE +/- .
'Y' TO SELECT
```

To require technician numbers change YES or NO using the (+) or (-) key. Press (Y Enter) to select.

```
>REQUIRE VISUAL
CHECKS? NO
USE +/- .
'Y' TO CONTINUE
```

To require visual checks change YES or No using the (+) or (-) key. Press (Y Enter) to select.

```
>REQUIRE BATTERY
DATE CODES? NO
USE +/- .
'Y' TO SELECT
```

To require battery date codes change YES or No using the (+) or (-) key. Press (Y Enter) to select.

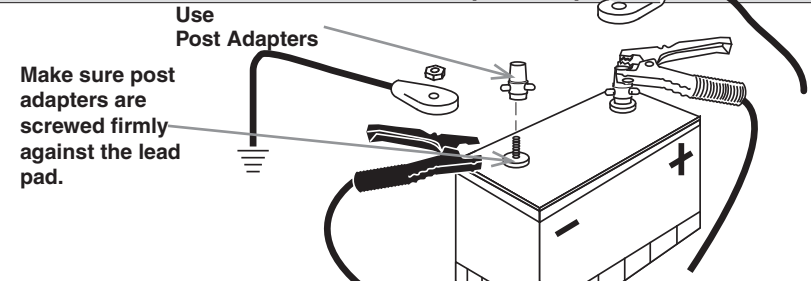

```
>ENTER BATTERY
DATE CODE: A4
USE +/- . 01/04
'Y' TO CONTINUE
```

The prompt only appears if the user requests it in the SETUP. The first letter should be flashing, this is the month. Using the (+) or (-) adjust the month, then press enter. the year will then flash use the (+) or (-) to select the correct year. 'Y' to continue.

```
>ENTER BATTERY
TEMP. 70F.
12.39V
'Y' TO CONTINUE
```

Using the (+) or (-) key adjust the temperature in units of 10 degrees. This should be the temperature of the battery.

```
>ENTER BATT TYPE
AGM USE +/- .
12.39V
'Y' TO CONTINUE
```

Use the (+) or (-) key to select the battery type, either AGM or regular lead-acid.

```
>ENTER RATED CCA
650
12.39V
'Y' TO BEGIN
```

Using the (+) or (-) key adjust the CCA of the battery. Press (Y Enter) to begin test.

```
TESTING BATTERY
PLEASE WAIT...
```

Wait for results.

There are five test results which are explained in detail on Pg. 12

Make sure they are correct when done.

```
#220 12V BATTERY
GOOD NEEDS CHRG.
12.28 CHARGE 54%
EST CCA 840
```

FIVE TEST RESULTS

GOOD BATTERY

- The battery has passed the load and capacity tests and is at a high enough state of charge to continue all electrical test or operate.

MARGINAL BATTERY

- The battery has lost capacity and should be replaced if in a critical or harsh situation.

BAD BATTERY

- The battery was at a high enough state of charge to test and failed. Replace battery.

GOOD, NEEDS CHARGING

- Battery tested good, however it needs to be charged before going into operation, normal vehicle operation might not charge this battery(s). All batteries need to leave the repair facility at or near 100% state of charge for good electrical performance.

CHARGE AND TEST

- The battery is at a low state of charge and can not be accurately tested unless it has been charged, Depending on the charger model, several hours may be needed to fully recharge and be ready to test.

VOLT METER

```
ALTERNATOR  ↑
STARTER TEST
REVIEW PRINT
>VOLT METER  ↓
```

Select VOLT METER from the main menu and press (Y Enter).

This gives the user a chance to check the voltage from the large clamps and the external leads.

```
-VOLT METER-
VOLTS: 12.28V.
EXT VOLTS: 3.77V
0.00 POS 0.00NEG
```

```
-VOLT METER-
VOLTS: 12.28V.
EXT VOLTS: 3.77V
RIPPLE: 0.00MV
```

Press (Y Enter) to switch between screens showing voltage drop or ripple

J1708 DATA

```
STARTER TEST  ↑
REVIEW/PRINT
VOLT METER
>J1708 DATA  ↓
```

Select J1708 for the main menu and press (Y Enter).

```
ERROR: J1708
NOT READING
```

If ERROR appears the connections has not been established.

```
VIN: 12345689A
BATTERY 14.10V.
OIL TEMP 68F.
AMB. TEMP. 75F.
```

```
VIN: 12345689A
BATTERY 14.10V.
OIL TEMP 68F.
AMB. TEMP. 75F.
```

Press (Y Enter) to switch between screens.

This gives the user a chance to check the J1708 connections and obtain pertinent information such as the ambient temperature for later use in testing the battery. Keep in mind that the ambient temperature may not be the actual temperature of the battery unless the vehicle battery has been in the place sufficient time for the battery to reach the surrounding ambient temperature. A low oil temperature would add a greater demand on the starter. This information is used by the BCT-200J to calculate the condition of the starter.

PRINTING TEST RESULTS

Point the BCT-200J in the direction of the optional PR-15 printer with the printer's IR receiver pointed in the direction of the BCT-200J. Press (Print). You should be within 15 ft. of the printer. Wait for the screen to clear before moving the BCT-200J. It takes a moment to send all the test data. The BCT-200J also operates the AC-14 printer installed in Auto Meter's XTC-160 tester/charger or BVA-2100 heavy duty tester/analyzer.

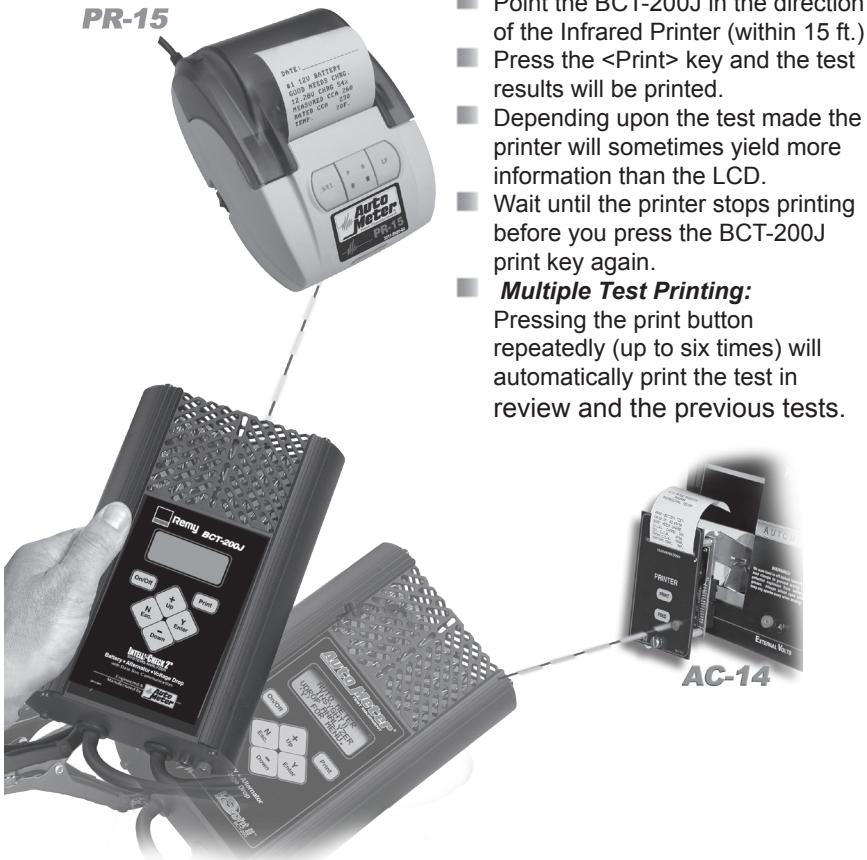

- Make sure the Infrared Printer is properly set up.
- After a test is made with the BCT-200J make sure the results are displayed on the LCD.
- Point the BCT-200J in the direction of the Infrared Printer (within 15 ft.)
- Press the <Print> key and the test results will be printed.
- Depending upon the test made the printer will sometimes yield more information than the LCD.
- Wait until the printer stops printing before you press the BCT-200J print key again.
- **Multiple Test Printing:**
Pressing the print button repeatedly (up to six times) will automatically print the test in review and the previous tests.

Example warranty code:

WARRANTY CODE

2BC0813280B012H12

For battery, starter, and alternator tests a unique warranty code is generated and printed at the bottom of the printout. This code is used for data and warranty verification.

4

CHARGING CABLE VDROPTM TEST

ALTERNATOR HOOKUP

Red to Positive

Black to Ground

Connect the large leads to the alternator pos. on output terminal and neg. on case.

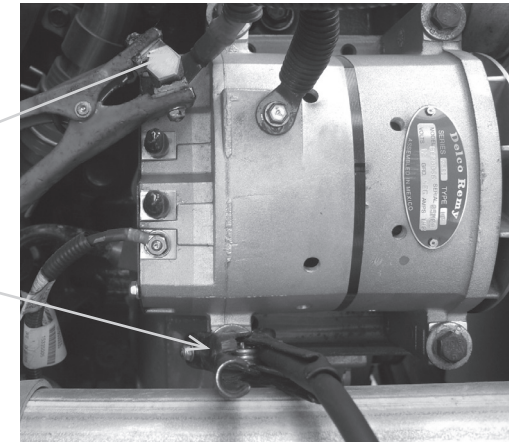

```
>CONNECT SMALL  
LEADS TO THE  
BATTERY  
'Y' TO BEGIN
```

Connect the small leads to the battery bank - the red on the positive main and the black on the negative main and not to an individual battery. The added small external leads will check the cables before the alternator is tested. This is the individual VDrop Test

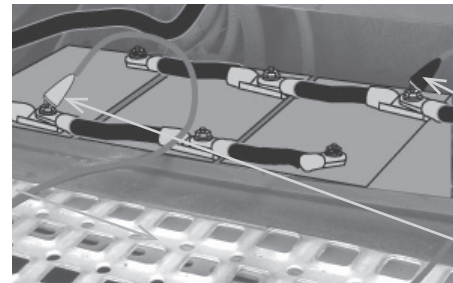

Black Clamp at Negative Main

BATTERY HOOKUP

Red Clamp at Positive Main

```
PM TEST  
BATTERY TEST  
BATTERY BANK  
>VDROP MENU
```

This same test and hookup can be run individually by selecting VDrop Menu

```
>CHARGING CABLES  
STR MAIN CABLES  
MAG. CIRCUIT  
LIFEGATE VDORP
```

...and then Charging Cables.

CHARGING CABLE VDROPTM (Cont.)

LOADING
PLEASE WAIT...

The Charging System Test performs this individual VDrop Test before allowing you to test the alternator's output.

If all connections are correct press (Y Enter) to begin VDrop Test. Wait for a load to be applied.

#7 CHRGR CABLES
PASSED @ 130A
GOOD TO 192A
0.15POS 0.19NEG

#8 CHRGR CABLES
OUT OF SPEC @
135A GOOD TO 123A
0.16POS 0.46NEG.

The results will vary depending upon the conditions of the cables. Both the positive and negative circuit results will be indicated. If the test does not pass, correct the connection or replace the cable and run the test again. The BCT-200J will automatically resume the test after it is disconnected. Just answer 'YES' when prompted.

Determining if the charging circuit is a "single" or "dual" system

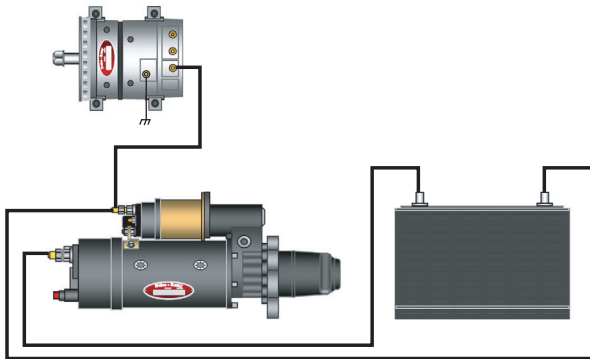

Single has one cable from the alternator output terminal.

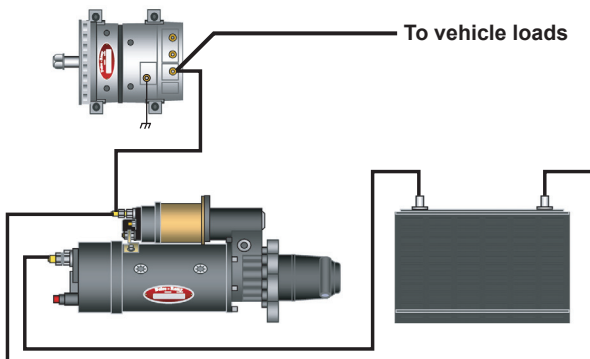

Dual system has two cables attached to the output terminal. Every load that the tractor and trailer utilize must be subtracted from the amount of current that can go to the batteries.

REVIEW TESTS

From the main menu select **REVIEW/PRINT**

VDROP MENU
ALTERNATOR
STARTER TEST
>REVIEW/PRINT

The last test will be displayed.

Press (+Up) or (-Down) key to select the desired test. Press

#30 12V BATTERY
GOOD BATTERY
12.55V CHRG 85%
EST. CCA 810

(N Esc.) to select MAIN MENU.

OPTIONAL INFRARED PRINTER

The optional PR-15 printer receives an infrared beam from the BCT-200J up to 40 ft. No connection cords are needed. For more instructions on how to operate the printer consult the printer manual.

Printer Type -----Thermal
Print Speed-----24-char. line per second
Paper-----2.25 in x 80 ft. roll (included)*
Power----- AC Adapter

Note: Thermal Paper can be purchased at any office supply.

CLAMP INSPECTION

IMPORTANT: Both jaws of each clamp must firmly engage all terminals. The copper jaw contains the smaller gauge wire that reads the voltage and the silver jaw contains the larger conducting wire that draws the load in each test. Jaw insulation is necessary for accurate readings. Damaged clamps or loose wires will affect the readings. Keep clamps clean and in good repair. **DO NOT ATTEMPT TO REPLACE CLAMPS WITH ANYTHING OTHER THAN AUTO METER CLAMPS.**

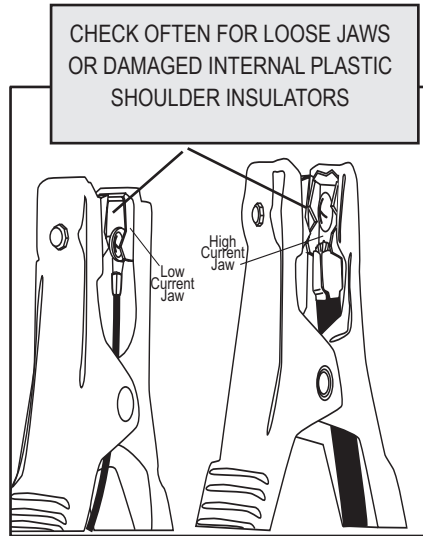

BATTERY CLAMP REPLACEMENT

Over time the battery clamps will need to be replaced if the following are indicated:

- CCA values seem to be way off.
- If there is continuity between the silver and copper jaw.
- If there is excessive damage or corrosion to the cables or clamps.

PROCEDURE

- Disconnect the back cover.
- Remove the battery to prevent shorting.
- Disconnect the two small wires from the PC board.
- Remove the large cables from the copper busses.
- Carefully pull each wire through the grommets.
- Reverse the procedure in replacing new clamps.
- **Caution:** Make sure the red clamp wires are attached to the positive buss and the black clamp is attached to the negative buss. Putting a little mineral spirits on the new cable ends will increase ease of insertion through the grommets.

BATTERY REPLACEMENT

When the LCD indicates a low internal battery. Remove the back cover and replace the battery with a 9 volt Alkaline battery.

VDROP ERROR MESSAGES

One of the following may appear during any drop test sequence. Correct the situation before continuing.

ERROR:
LARGE LEADS
NOT CONNECTED
'Y' TO CONTINUE

One or both of the large leads are not connected.

ERROR:
BAD CONNECTION
ON LARGE LEADS
'Y' TO CONTINUE

Tester detected that one of the large leads does not have a good connection.

ERROR:
CHECK LARGE
BLACK LEAD
'Y' TO CONTINUE

Tester detected that the large black lead is not connected properly

ERROR:
CHECK LARGE
RED LEAD
'Y' TO CONTINUE

Tester detected that the large red lead is not connected properly

Note: On the large leads, both sides of the jaws must make a good connection

ERROR:
SMALL LEADS
NOT CONNECTED
'Y' TO CONTINUE

One or both of the small external leads is not connected

ERROR:
SMALL LEADS
REVERSED
'Y' TO CONTINUE

The tester detected that the small leads are hooked up backwards the tester should also beep when it occurs

5

STANDARD ALTERNATOR OUTPUT TEST

After the battery or batteries have been tested and were good (or have been replaced) and after the charging cables have been tested and were good (or were repaired or replaced) you may proceed to test the alternator.

```
BATTERY TEST  ↑
BATTERY BANK
VDROP TEST
>ALTERNATOR  ↓
```

This test can also be selected from the main menu by selecting Alternator Test then press (Y Enter).

```
>INSPECT BELT
CONDITION.

'Y' TO CONTINUE
```

If the unit is setup to require visual checks you will be asked to inspect belt condition...

See picture below
...and tension.

```
>INSPECT BELT
TENSION.

'Y' TO CONTINUE
```

```
>INSPECT CABLES
AND CONNECTIONS

'Y' TO CONTINUE
```

Inspect cables and connections before alternator rating is entered.

```
CONNECT LARGE LEADS
TO THE ALTERNATOR

'Y' TO CONTINUE
```

Red to output terminal and Black to ground / case output adapters recommended.

```
CONNECT LARGE LEADS
TO THE ALTERNATOR

'Y' TO CONTINUE
```

Check the alternator tag or housing and use the +/- key to select the rated output



ALTERNATOR BENCH TESTING (Cont.)

```
#48 12V BENCH BAD
ALTERNATOR HIGH
RIPPLE
REG.      14.39V
```

```
#147 12V ALTER.
GOOD REG.  14.15V
GOOD DIODE
GOOD OUTPUT
```

This result indicates the alternator is in good working order

```
#149 12V ALTER.
LOW REG.   12.74V
BAD DIODE
LOW OUTPUT
```

This is a defective alternator. It has a defective component and is producing high ripple

```
#151 12V ALTER.
HIGH REG.  15.02V
BAD DIODE
PARTIAL OUTPUT
```

This is a defective alternator. Not only does it have defective components - the regulation set point is high.

```
#148 12V ALTER.
LOW REG.   12.74V
LOW OUTPUT
```

This is a defective alternator. The output and regulation are low. Defective batteries can cause this condition

```
#150 12V ALTER.
HIGH REG.  15.02V
GOOD DIODE
LOW OUTPUT
```

Defective alternator. It can not handle the load and it is regulating high.

ALTERNATOR BENCH TESTING (Cont.)

STANDARD ALTERNATOR OUTPUT TEST (Cont.)

ALLOWING VOLTAGE
TO STABILIZE
14.47V.
PLEASE WAIT . . .

TESTING
ALTERNATOR
14.47V.
PLEASE WAIT . . .

VERIFY THAT BELT
IS AROUND LARGE
FULLEY.
'Y' TO CONTINUE

TURN MOTOR SWITCH
OFF.

'Y' TO CONTINUE.

TURN BATTERY
SWITCH OFF.

'N' TO CANCEL

TURN BENCH POWER
SWITCH OFF.

'Y' TO CONTINUE

#45 12V BENCH
GOOD ALTERNATOR
GOOD REG. 14.47V

If this prompt shows up during the alternator test then verify that the belt goes around the large pulley on the bench motor and that the correct pulley is used on the alternator. If the correct pulleys are being used then press Y/ Enter to continue otherwise press N/Cancel and use the correct pulleys.

After the BCT-200J has tested the alternator it will prompt for the motor, the battery switch and the bench power to be turned off.

After the bench is turned off the BCT-200J will report the condition of the alternator.

DOES ALTERNATOR
HAVE A
REMOTE SENSE?
'N' OR 'Y'

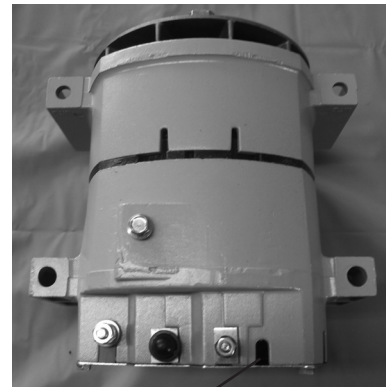

Non Remote Sense (empty port)

DOES VEHICLE HAVE
J-1708 DATA PORT?
'N' OR 'Y'

>ATTACH J-1708
DATA CABLE
'N' TO CANCEL

TURN IGNITION
SWITCH ON

See photo of non remote sense alternator below "N" for Non-remote sense alternator

Non Remote Sense Alternator



If vehicle is equipped with a J-1708 port and you have the optional cable. Select "Y". If vehicle is not equipped with J-1708 data port or you don't have an optional J-1708 cable select "N"

If NO skip the next two steps.

Attach the cable from the tester to the data port on the vehicle.

NOTE: if the tester does not detect it is hooked to the data port it will not go beyond this screen.

Once it detects it is hooked up properly it will prompt you to turn the ignition key to the run position.

STANDARD ALTERNATOR TEST RESULTS

ALTERNATOR BENCH TESTING (Cont.)

>CONNECT R CLIP
TO THE R TERM
ON ALTERNATOR
'Y' TO CONTINUE

Connect the single alligator clip
from the AC-26 J1708 cable to the R
terminal on the alternator.

Output terminal adapter utilized

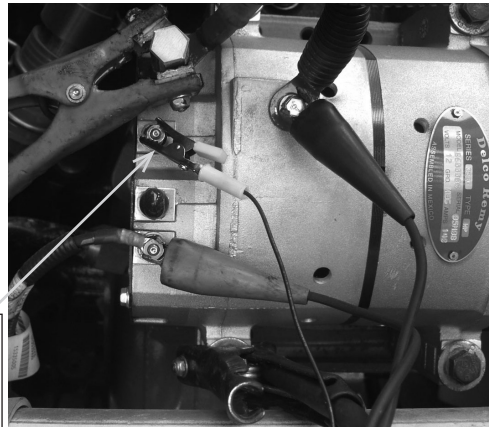

>START ENGINE.
SET IDLE AT
ABOUT 1000 RPM
'N' TO CANCEL

Make sure all is clear. Start engine
and run at fast idle - 1,000 RPM.

>ALLOW VOLTAGE
TO STABILIZE.
14.20V
'Y' TO BEGIN

You **MUST** allow voltage to stabilize
for an accurate test. If, voltage is low,
tester will start a one minute clock to
ensure proper test.

>REV ENGINE TO
GOV. FOR 10 S.
'N' TO CANCEL

Rev the engine to governed speed
for 10 seconds. If no results appear
press (Y Enter).

FLIP BATTERY
SWITCH TO
ALTERNATOR.
'N' TO CANCEL.

CHECKING BENCH
BATTERY

PLEASE WAIT . . .

TURN OFF OR
DISCONNECT
CHARGER.
'Y' TO CONTINUE

The BCT 200J will check the bench
battery to ensure that it is charged and
sufficiently good to continue with the
alternator test.

If the battery has a charger connected
to it the charger must be turned off or
disconnected to continue with the
alternator test.

BENCH BATTERY OR
CABLES ARE
DEFECTIVE.
'Y' TO CONTINUE

If the bench battery is too weak or if the
cables or leads of the bench have too
high of a voltage drop then the battery
and/or cables will need to be serviced
before continuing with the alternator
test.

BENCH BATTERY IS
LOW, CHARGE OR
REPLACE.
'Y' TO CONTINUE

If the bench battery is discharged then
charge or replace the battery before
continuing with the alternator test.

ENTER RATED
ALTERNATOR
OUTPUT: 100A
'Y' TO CONTINUE

Set the rated output of the alternator.
The rated output is sometimes marked
on the alternator, if it is not marked on
the alternator check the manufacturer's
documentation.

TURN MOTOR SWITCH
TO FWD.
'Y' TO CONTINUE

Turn the bench motor on to spin the
alternator. If the nut to hold the pulley
on the alternator has right-hand threads
then by turning the motor forward the
chances of the pulley coming loose
during the test will be reduced.

ALTERNATOR BENCH TESTING (Cont.)

STANDARD ALTERNATOR TEST RESULTS

```
ALTERNATOR AND  
TESTER SHOULD BE  
HOOKED UP.  
'Y' TO CONTINUE
```

If the prompts are skipped over by pressing the +/Up key then a prompt is displayed indicating that the alternator and the tester should at this point be connected to the bench. After verifying that the setup is correct press the Y/Enter key to continue.

```
DOES  
ALTERNATOR HAVE A  
REMOTE SENSE.  
'N' OR 'Y'
```

Some alternators have a remote sense post to enable the alternator to regulate the voltage at the battery instead of at the alternator. If the alternator has a remote sense post then the remote sense post must be attached to the output post of the alternator to test the alternator on the bench. Otherwise the alternator's regulator will not be connected and the alternator's output voltage will be high.

```
CONNECT REMOTE  
SENSE POST TO  
OUTPUT POST.  
'Y' TO CONTINUE
```

```
TURN BENCH POWER  
SWITCH ON.
```

```
'Y' TO CONTINUE
```

Note: Output terminal and ground post adapters utilized. Model AC-27

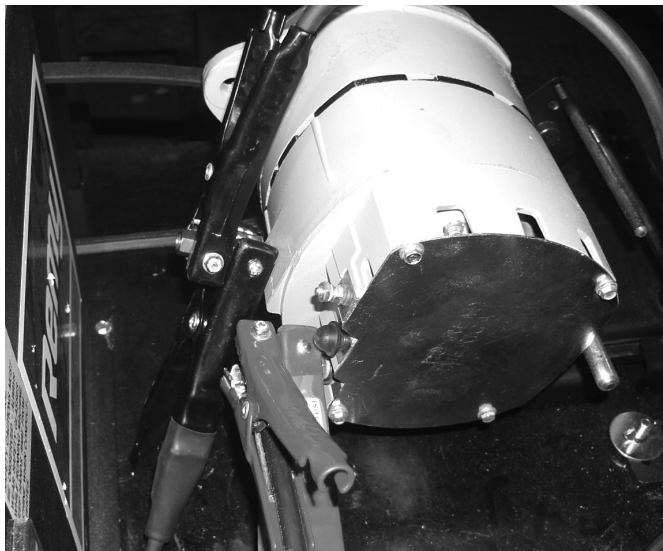

```
TESTING ALT.  
PLEASE WAIT...
```

Wait for test to complete its testing cycle.

```
#147 12V ALTER.  
GOOD REG. 14.15V  
GOOD DIODE  
GOOD OUTPUT
```

This result indicates the alternator is in good working order.

```
#149 12V ALTER.  
LOW REG. 12.74V  
BAD DIODE  
LOW OUTPUT
```

This is a defective alternator. It has a defective component and is producing high ripple.

```
#151 12V ALTER.  
HIGH REG. 15.02V  
BAD DIODE  
PARTIAL OUTPUT
```

This is a defective alternator. Not only does it have defective components the regulation set point is high.

```
#148 12V ALTER.  
LOW REG. 12.74V  
LOW OUTPUT
```

This is a defective alternator. The output and regulation are low. Defective batteries can cause this condition.

```
#150 12V ALTER.  
HIGH REG. 15.02V  
GOOD DIODE  
LOW OUTPUT
```

Defective alternator. It can not handle the load and it is regulating high.

REMOTE SENSE ALTERNATOR OUTPUT TEST

After the battery or batteries have been tested and were good (or have been replaced) and after the charging cables have been tested and were good (or were repaired or replaced) you may proceed to test the alternator.

```
BATTERY TEST ↑
BATTERY BANK
VDROP TEST
>ALTERNATOR ↓
```

This test can also be selected from the main menu by selecting Alternator Test then press (Y Enter).

```
>INSPECT BELT
CONDITION.

'Y' TO CONTINUE
```

If the unit is setup to require visual checks you will be asked to inspect belt condition...

See picture below

...and tension.

```
>INSPECT BELT
TENSION.

'Y' TO CONTINUE
```



```
>INSPECT CABLES
AND CONNECTIONS

'Y' TO CONTINUE
```

Inspect cables and connections before alternator rating is entered.

```
CONNECT LARGE LEADS
TO THE ALTERNATOR

'Y' TO CONTINUE
```

Red to output terminal and Black to ground / case output adapters recommended.

```
CONNECT LARGE LEADS
TO THE ALTERNATOR

'Y' TO CONTINUE
```

Check the alternator tag or housing and use the +/- key to select the rated output.

ALTERNATOR BENCH TESTING (Cont.)

```
MAKE SURE THAT
THE BELT IS
STRAIGHT.
'Y' TO SCROLL
```

Align the belt so that it is straight and will not come off.

```
TIGHTEN THE BELT

'Y' TO SCROLL
```

Make sure the belt is tight so that it will be able to properly turn the alternator under load.

```
ATTACH BLACK
BENCH LEAD TO
GROUND ADAPTER.
'Y' TO SCROLL
```

Securely attach the black bench lead to the alternator's casing or to the ground adapter post (if the alternator has a ground post instead of a case ground).

```
ATTACH BLACK
TESTER LEAD TO
ALTERNATOR.
'Y' TO SCROLL
```

Also attach the black lead from the BCT 200J to the alternator's casing or to the ground post (if the alternator has a ground post instead of a case ground).

```
ATTACH POSITIVE
ADAPTER TO
ALTERNATOR
'Y' TO SCROLL
```

The AC-27 adapter makes it possible to attach the red lead from the bench and the red lead from the BCT 200J to the alternator output post. Be sure to thread the adapter completely onto the output post of the alternator and tighten.

```
ATTACH RED BENCH
LEAD TO POSITIVE
ADAPTER.
'Y' TO SCROLL
```

```
ATTACH RED TESTER
LEAD TO POSITIVE
ADAPTER.
'Y' TO SCROLL
```

The Bench Test is used to test the alternator that has been removed from the vehicle and setup on an alternator test bench.

ALTERNATOR
STARTER TEST
REVIEW/PRINT
>BENCH TEST

From the main menu select Bench Test and press Y/Enter.

PRESS 'Y' TO
SCROLL THROUGH
BENCH SETUP OR
'+' TO SKIP

Press 'Y' to scroll through the prompts for connecting the alternator to the bench or press the +/Up key to skip over the prompts to attach the alternator and the test leads.

REMOVE THE
ALTERNATOR PULLEY

'Y' TO SCROLL

If the pulley that is on the alternator is a different size or different style than the pulley that comes with the bench, then remove the pulley from the alternator and attach the pulley that goes with the bench to the alternator.

ATTACH BENCH
PULLEY TO THE
ALTERNATOR.
'Y' TO SCROLL

Utilize the proper size pulley that works with the tester.

ATTACH THE
ALTERNATOR TO THE
BENCH.
'Y' TO SCROLL

Securely mount the alternator to the bench following the instructions for the bench.

ROUTE BELT OVER
LARGE BENCH
PULLEY.
'Y' TO SCROLL

It is important that the belt go around the large pulley that is attached to the bench motor. If the small pulley on the bench motor is used or if a larger pulley is used on the alternator then the bench will not spin the alternator at full speed.

DOES ALTERNATOR
HAVE A REMOTE SENSE?

'N' OR 'Y'

See photo of remote sense alternator.

Select 'Y' for remote sense

Remote Sense

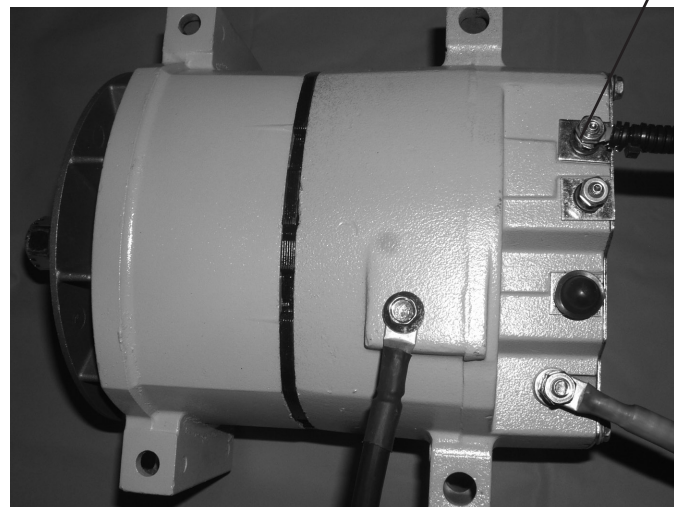

CONNECT SMALL
CLIPS TO THE
REMOTE TERM/GND
'Y' TO CONTINUE

Use the small ext leads and connect the red to the remote sense port and the black to the Alt ground.

ERROR:
FAULTY REMOTE
SENSE WIRE
'Y' TO CONTINUE

If the tester does not see battery voltage this error will appear.

DOES VEHICLE HAVE
J-1708 DATA PORT?

'N' OR 'Y'

If vehicle is equipped with a J-1708 port and you have the optional cable. Select 'Y'. If vehicle is not equipped with J-1708 data port or you don't have an optional J-1708 cable select 'N' If NO skip the next two steps.

REMOTE SENSE ALTERNATOR TEST (Cont.)

```
>ATTACH J-1708
DATA CABLE

'N' TO CANCEL
```

Attach the cable from the tester to the data port on the vehicle.

NOTE: if the tester does not detect it is hooked to the data port it will not go beyond this screen.

```
TURN IGNITION
SWITCH ON
```

Once it detects it is hooked up properly it will prompt you to turn the ignition key to the run position.

```
>CONNECT R CLIP
TO THE R TERM
ON ALTERNATOR
'Y' TO CONTINUE
```

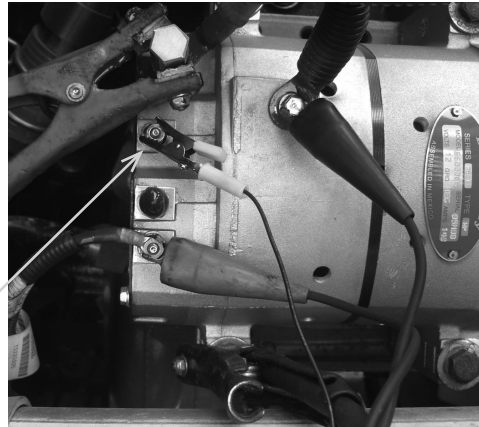

Connect the single alligator clip from the AC-26 J1708 cable to the R terminal on the alternator.

Output terminal adapter utilized

```
>START ENGINE.
SET IDLE AT
ABOUT 1000 RPM
'N' TO CANCEL
```

Make sure all is clear. Start engine and run at fast idle - 1,000 RPM

```
>ALLOW VOLTAGE
TO STABILIZE.
14.20V
'Y' TO BEGIN
```

You MUST allow voltage to stabilize for an accurate test. If, voltage is low, tester will start a one minute clock to ensure proper test.

DEFINITIONS - SYSTEM SPECIFICATIONS

BATTERY TEST

During each battery test the BCT-200J uses various results that are displayed after each test. The definition of those results are as follows:

- **% Charge** = an approximate amount of charge the battery is currently holding. This is based upon the batteries voltage.
- **Est. CCA** = is the approximate CCA of the fully charged battery.
- **GOOD BATTERY** = a battery that is good and is charged.
- **GOOD NEEDS CHARGE** = a battery that is good but is low on charge.
- **MARGINAL BATTERY** = a battery that has passed the load test but the estimated CCA is getting low or the battery is approaching its end of life.
- **CHARGE and RETEST** = a battery with insufficient charge to provide accurate test results.
- **BAD BATTERY** = a battery that is bad and should be replaced. A bad battery is a battery that failed the load test or had an estimated CCA below about 70% of the rated value.

VOLTAGE DROP TESTS

The specifications for those tests are listed below.

TEST	SYSTEM	PASS/FAIL
Charging Cables	12 Volt	Maximum drop at rated alternator output is 0.5 Volts
	24 Volt	Maximum drop at rated alternator output is 1.0 Volts
Main Starting Cables	12 Volt	Maximum drop at 500 Amps is 0.5 Volts
	24 Volt	Maximum drop at 250 Amps is 1.0 Volts
Magnetic Circuit Straight Drive	12 Volt	Maximum drop at 80 Amps is 1.0 Volts
	24 Volt	Maximum drop at 40 Amps is 2.0 Volts
Magnetic Circuit Gear Reduction	12 Volt	Maximum drop at 300 Amps is 1.0 Volts
	24 Volt	Maximum drop at 225 Amps is 2.0 Volts
Generic Voltage Drop Test	12 Volt	Reports the drops at the entered current
	24 Volt	Reports the drops at the entered current

The minimum system voltage to run a test is 12.25 Volts for a 12 Volt system and 24.5 Volts for a 24 Volt system.

LIFTGATE VDROPTM TESTS (Cont.)

Generic System Setup

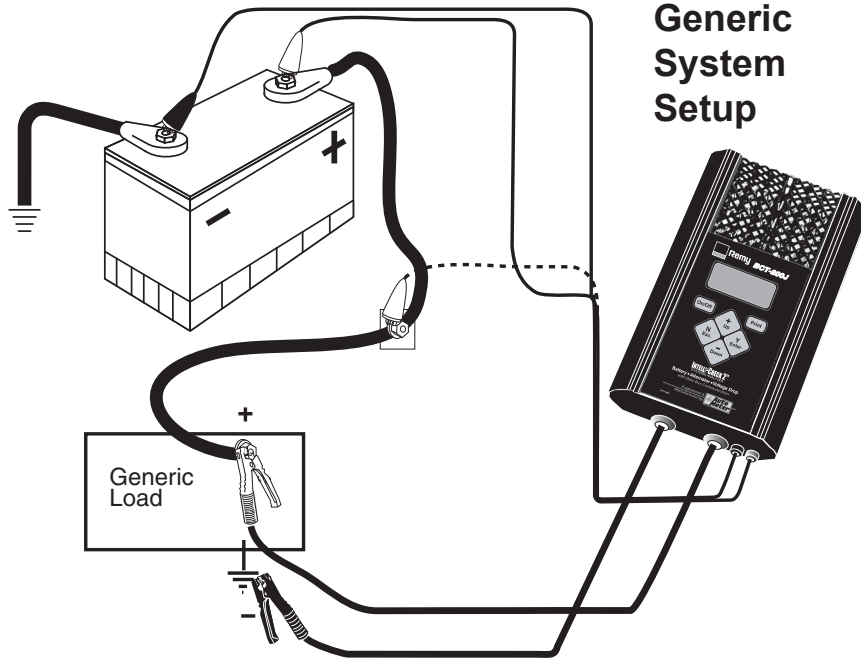

```
>CONNECT SMALL
LEADS TO THE
SYSTEM.
'Y' TO CONTINUE
```

Then connect small leads to the battery or along the circuit being tested as illustrated in the setup and press (Y Enter).

```
LOADING
PLEASE WAIT...
```

If all connections are correct, wait for a load to be applied.

```
#28 GEN. VDROPTM
VOLTAGE DROPS
AT 150 AMPS
0.33 POS 0.32 NEG
```

The results will vary depending upon and the conditions of the cables. Both the positive and negative circuit results will be indicated from the single test.

If the overall voltage drop is not within the desired specifications the small leads can be moved closer along the line being tested and the test run again (see dotted lead on previous page). If the results are desirable, it is the section not included in the last test. If the results are not desirable the problem is most likely in the section being tested. Repair and test the entire section again.

REMOTE SENSE ALTERNATOR TEST (Cont.)

```
>REV ENGINE TO
GOV. FOR 10 S.
'N' TO CANCEL
```

Rev the engine to governed speed for 10 seconds. If no results appear press (Y Enter).

```
TESTING ALT.
PLEASE WAIT...
```

Wait for test to complete its testing cycle.

```
#147 12V ALTER.
GOOD REG. 14.15V
GOOD DIODE
GOOD OUTPUT
```

This result indicates the alternator is in good working order.

```
#149 12V ALTER.
LOW REG. 12.74V
BAD DIODE
LOW OUTPUT
```

This is a defective alternator. It has a defective component and is producing high ripple.

```
#151 12V ALTER.
HIGH REG. 15.02V
BAD DIODE
PARTIAL OUTPUT
```

This is a defective alternator. Not only does it have defective components - the regulation set point is high.

```
#148 12V ALTER.
LOW REG. 12.74V
LOW OUTPUT
```

This is a defective alternator. The output and regulation are low. Defective batteries can cause this condition.

```
#150 12V ALTER.
HIGH REG. 15.02V
GOOD DIODE
LOW OUTPUT
```

Defective alternator. It can not handle the loa and it is regulating high.

6 STARTING SYSTEM MAIN CABLE VDROPTM TEST

The circuit from the battery to the starter junction is being tested.

Note: If a split battery bank is used go to the Generic Starter Drop Test and perform a split battery procedure. See section 11. By disconnecting each bank and testing the other using the Generic Voltage Drop Test and entering one half the starter draw you can test the starter main cables individually. First of all determine if the system you are going to test is a “split” or “single” system.

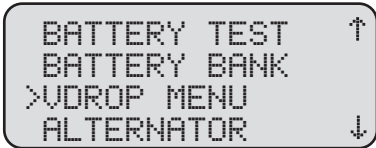

This test can be selected from the main menu by selecting VDROPTM MENU then by pressing (Y Enter).

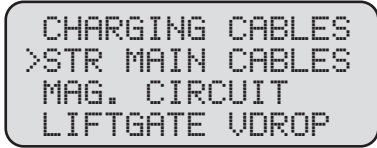

...select >STR. MAIN CABLES and press (Y Enter).

How to Determine if Single of Dual Cable System Chart

	# of Battery Boxes	# of Positive Cables	Type of System
A	1	1	Single
B	1	2	Dual
C	2	2	Dual

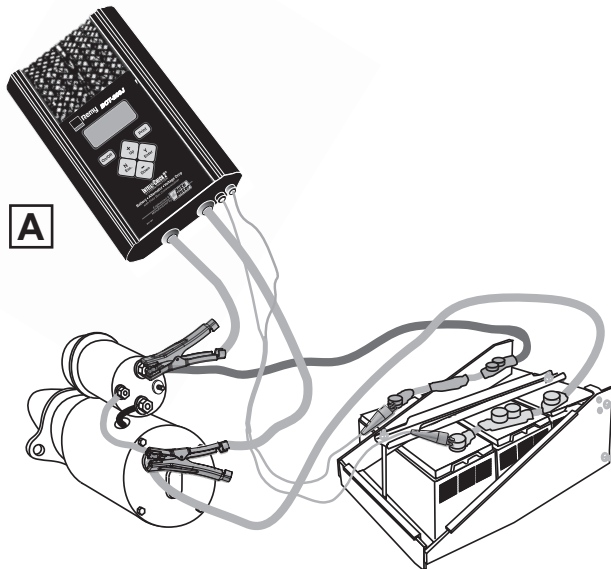

9 LIFTGATE VDROPTM TESTS

The various liftgate circuit voltage drop tests and the generic voltage drop test can be used to test the liftgate charging and motor circuits as well as any other circuit that includes a battery and cables and is designed to operate a load of 20 amps or more.

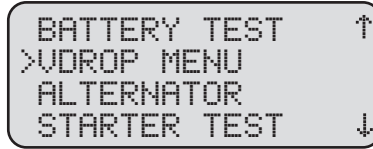

After selecting >VOLTAGE DROP from the main menu...

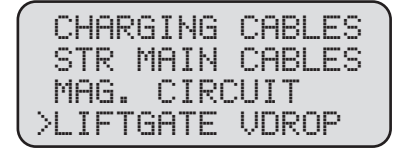

...select >LIFTGATE V DROP and press (Y Enter).

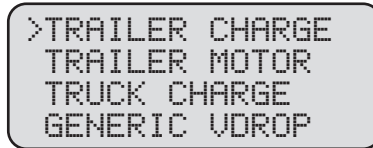

Select TRAILER CHARGE, TRAILER MOTOR or TRUCK CHARGE to perform a voltage drop test on the trailer charge circuit, trailer liftgate motor circuit or the truck's liftgate power circuit respectively.

The liftgate charging circuit includes the positive cables from the front of the trailer to the liftgate batteries and the negative cables and/or frame from the front of the trailer to the liftgate batteries.

The liftgate motor circuit includes the positive cables and the solenoid from the liftgate batteries to the liftgate motor and the negative cables and/or frame from the liftgate batteries to the liftgate motor.

The liftgate truck circuit includes the positive cables and the negative cables and/or frame from the trucks batteries to the front of the trailer (end of the “stinger” cord).

Adapters are available from Auto Meter to facilitate connecting the BCT-200J to single pole and dual pole connectors on both trucks and trailers. See the manual supplement that is included with those adapters for more detailed information on testing and trouble shooting the liftgate charging circuits and liftgate motor circuits.

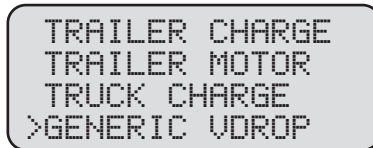

Select >GENERIC VDROPTM and press (Y Enter) to run the generic voltage drop test.

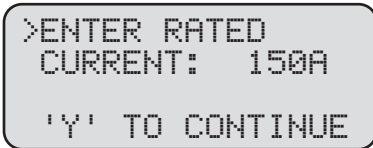

Using the (+/-) key adjust Amp rating to that of the generic load device.

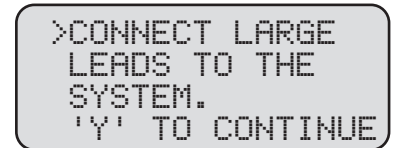

Connect large leads to the generic load.

NON OCP

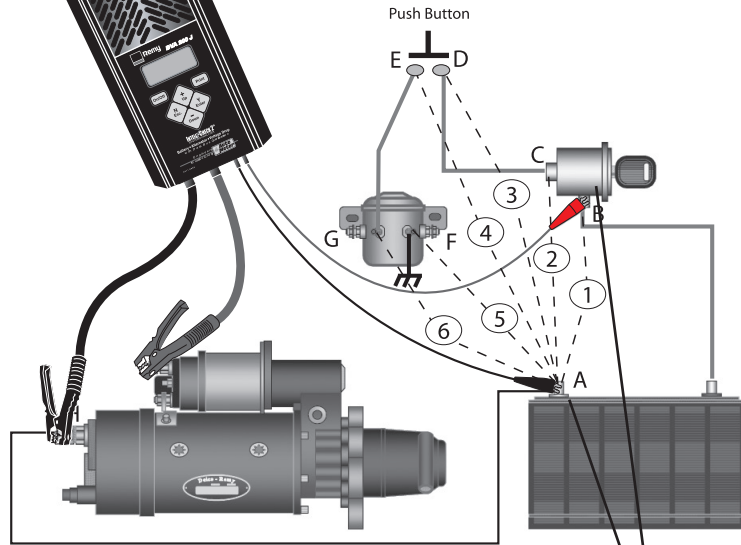

A= will always be the battery ground
 A to B tests power at key switch
 A to C tests power out of keyswitch
 A to D tests power at the push button
 A to E tests power out of the push button
 A to F tests ground at the mag switch
 A to G tests power at mag switch

Note: D & E tests only pertain to vehicles equipped with push button start

Example: Connect small black lead at A and small red lead on B

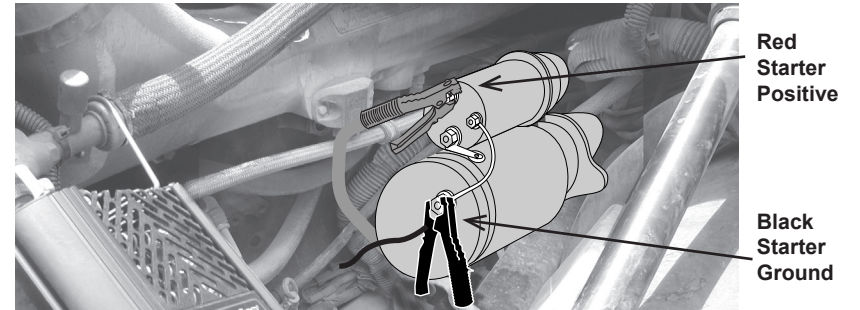

>CONNECT LARGE LEADS TO THE STARTER 'Y' TO CONTINUE

Connect large leads to the Starter

>CONNECT SMALL LEADS TO THE BATTERY 'Y' TO BEGIN

Then connect small leads to the battery bank – the red on the positive main and the black on the negative main and not to an individual battery. The added small external leads will check the main cables. Press (Y Enter).

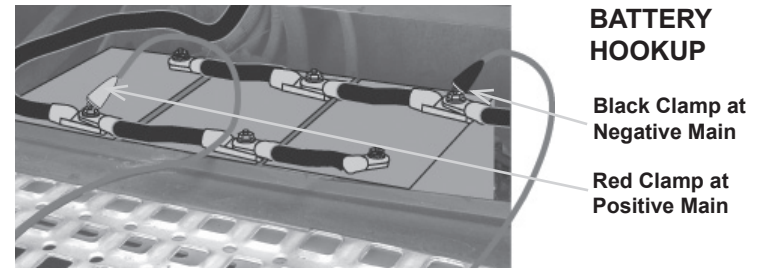

Just as the System Test checks the Magnetic Circuit first it also checks the main starting cables.

LOADING PLEASE WAIT...

If all connections are correct, wait for a load test to be performed.

The results will vary depending upon and the conditions of the cables. Both the positive and negative circuit results will be indicated from the single test. If the test does not pass, correct the connection or replace the cable and run the test again. The BCT-200J will automatically resume the test after it is disconnected. Just answer "Yes" when prompted.

STARTING MAIN CABLE VDROPTM (Cont.) SINGLE

KEY SWITCH VDROPTM TEST (Cont.) (OCP)

#10 MAIN CABLES
PASSED @ 500A
GOOD TO 545A
0.18 POS 0.13 NEG

#11 MAIN CABLES
OUT OF SPEC @ 500A
GOOD TO 375A
0.21POS 0.36NEG.

STARTING VDROPTM ... SPLIT SYSTEM TESTING PART A

BATTERY TEST
BATTERY BANK
>VDROP MENU
ALTERNATOR

CHARGING CABLES
STR MAIN CABLES
MAG. CIRCUIT
>LIFTGATE VDROPTM

TRAILER CHARGE
TRAILER MOTOR
TRUCK CHARGE
>GENERIC VDROPTM

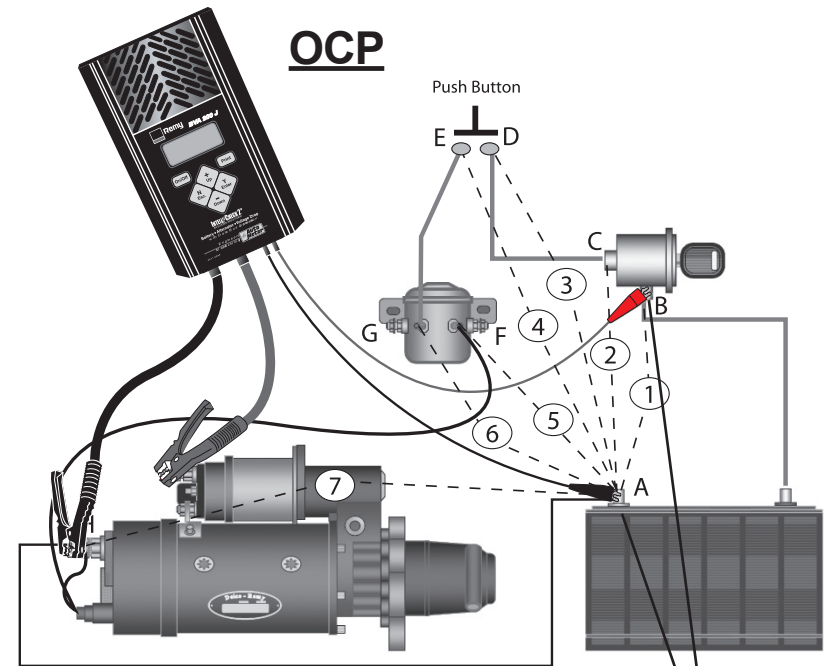
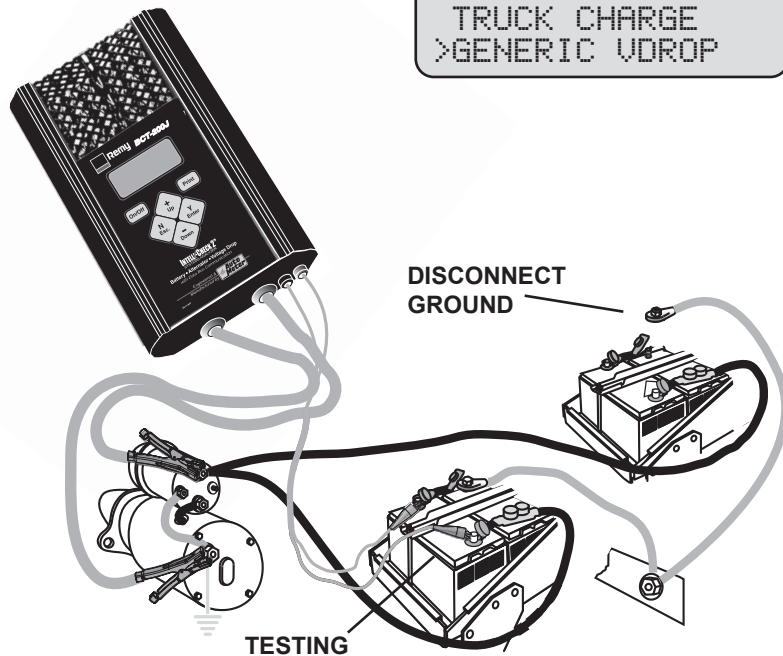

A= will always be the small black lead
A to B tests power at key switch
A to C tests power out of keyswitch
A to D tests power at the push button
A to E tests power out of the push button
A to F tests ground at the mag switch
A to G tests power at mag switch
A to H tests ground at starter

Note: D & E tests only pertain to vehicles equipped with push button start

Example: Connect small black lead at A and small red lead on B

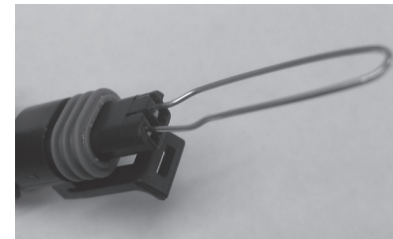

Note: For testing the OCP wiring the plug should be removed and a paper clip inserted in the connector body. (see picture)

KEY SWITCH VDROPTM TEST (Cont.)

SPLIT SYSTEM TESTING (Cont.) PART A

```
-VOLTMETER-  
VOLTS      0.00V  
EXT. V     12.63V  
0.00 POS  0.00 NEG
```

Should read voltage at ext. V. No voltage at magnetic switch coil with ignition key off.

```
-VOLTMETER-  
VOLTS      12.15V  
EXT. V     12.40V  
.15 POS   .10 NEG
```

Turn the ignition key to start position and hold. Observe both volt results. Voltage is at magnetic switch coil leads. External V is voltage at starter.

```
-VOLTMETER-  
VOLTS      12.15V  
EXT. V     12.40V  
.15 POS   .10 NEG
```

In this example the system passed, the total voltage drop is .25V which is less than the .5V drop allowed.

End of test.

```
-VOLTMETER-  
VOLTS      11.08V  
EXT. V     12V  
.33 POS   1.02 NEG
```

In this example the system is out of spec. The 1.35 volt drop exceeds the allowable .5 volt drop.

Continue testing each leg of the circuit.

```
ENTER RATED  
CURRENT: 250  
'Y' TO CONTINUE
```

Scroll to 250 amps.

```
CONNECT LARGE  
LEADS TO THE  
SYSTEM  
'Y' TO CONTINUE
```

Red to Starter battery post.
Black to Starter ground post.

```
CONNECT SMALL  
CLIPS TO THE  
SYSTEM  
'Y' TO BEGIN
```

Red to battery positive.
Black to battery negative.

```
LOADING . . .
```

```
#5 GENERIC VDROPTM  
VOLTAGE DROPS  
AT 250 AMPS  
.21 POS .16 NEG
```

You are allowed a total of 0.5 VDrop combined. Add the negative and positive voltage drop for total voltage drop. This example is within spec with a combined drop of only .37V

```
#6 GENERIC VDROPTM  
VOLTAGE DROPS  
AT 250 AMPS  
.35 POS .29 NEG
```

This example is out of spec with a total drop of .64V

The results will vary depending upon and the conditions of the cables. Both the positive and negative circuit results will be indicated from the single test. If the test does not pass, correct the connection or replace the cable and run the test again. The BCT-200J will automatically resume the test after it is disconnected. Just answer 'Yes' when prompted.

SPLIT SYSTEM TESTING (Cont.) PART B

Now test the other battery pack.

BATTERY TEST
BATTERY BANK
>VDROP MENU
ALTERNATOR

CHARGING CABLES
STR MAIN CABLES
MAG. CIRCUIT
>LIFTGATE VDROP

TRAILER CHARGE
TRAILER MOTOR
TRUCK CHARGE
>GENERIC VDROP

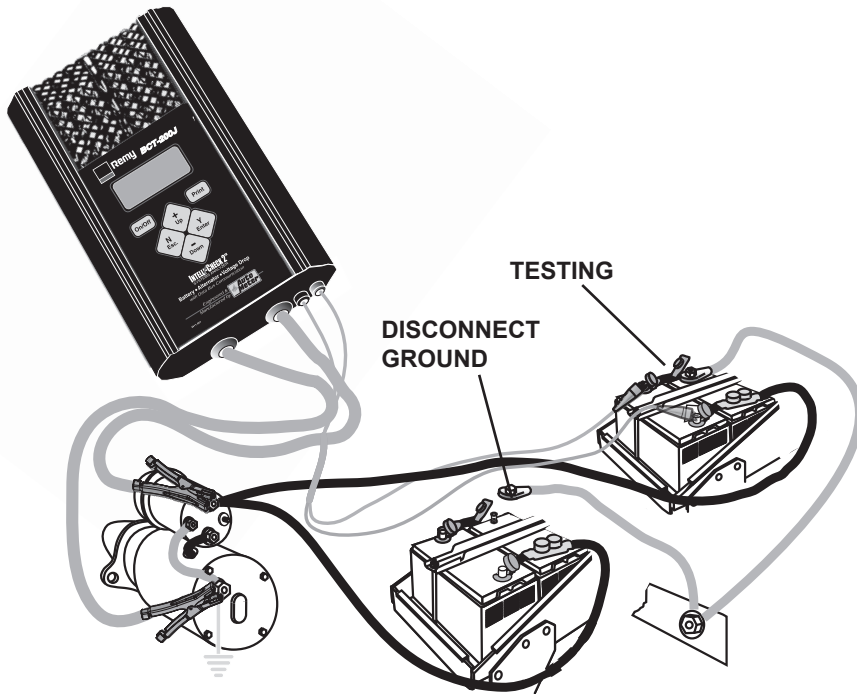

8

KEY SWITCH VDROP™ TEST

Note: This is a real time test and the operator must observe and record the data when the key switch is energized.

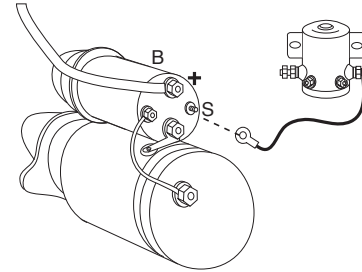

S-terminal wire must be removed from the solenoid so that the starter does not engage.

ALTERNATOR
STARTER TEST
REVIEW/PRINT
>VOLT METER

Scroll to Voltmeter

Connect large clips to magnetic switch coil.

Connect small leads to starter.

NOTE: Connections are the same for WITH OCP or WITHOUT OCP.

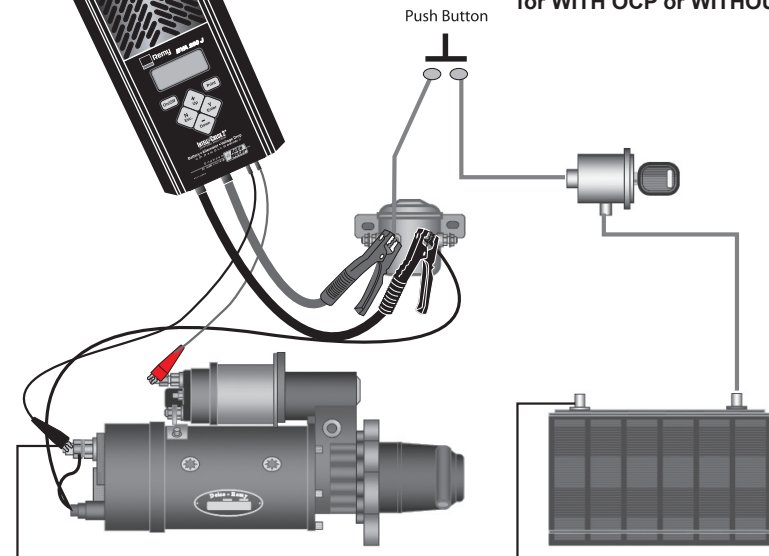

MAGNETIC CIRCUIT TEST (Cont.)

SPLIT SYSTEM TESTING (Cont.) PART B

```
#338 MAG/CIRCUIT  
OUT OF SPEC!  
DROP @ 80A: 1.54V  
'Y' TO CONTINUE
```

If the test was out of spec Press 'Y' and the BCT-200J will advance to the next menu. Excessive drop at rated load is indicated by more than 1 Volt drop at 80 Amps.

```
>MOVE THE SMALL  
RED LEAD TO THE  
MAG. "HOT"  
'Y' TO CONTINUE
```

Move the small red lead to the magnetic switch hot side connection from the battery (2), press enter and energize the switch again for 3-5 seconds (See Illustration - small clamp position 2).

```
>MOVE SMALL RED  
LEAD TO OTHER  
SIDE OF MAG.  
'Y' TO CONTINUE
```

Move the small red lead to the negative (-) side of the magnetic switch (3), press enter and energize again for 3-5 seconds (See Illustration - small clamp position 3).

```
#340 MAG/CABLES  
LEG1: 2.22V FAIL  
MAG.: 0.41V FAIL  
LEG2: 0.12V PASS
```

The final results will appear indicating the section of the circuit or switch that is in need of repair.

```
ENTER RATED  
CURRENT: 250  
'Y' TO CONTINUE
```

Scroll to 250 amps.

```
CONNECT LARGE  
LEADS TO THE  
SYSTEM  
'Y' TO CONTINUE
```

Red to Starter Solenoid battery post.
Black to Starter ground post.

```
CONNECT SMALL  
CLIPS TO THE  
SYSTEM  
'Y' TO BEGIN
```

Red to battery positive.
Black to battery negative.

```
LOADING . . .
```

```
#5 GENERIC VDROP  
VOLTAGE DROPS  
AT 250 AMPS  
.15 POS .19 NEG
```

You are allowed a total of 0.5 VDrop combined. Add the negative and positive voltage drop for total voltage drop. This example is within spec with a combined drop of only .34V

```
#6 GENERIC VDROP  
VOLTAGE DROPS  
AT 250 AMPS  
.18 POS .41 NEG
```

This example is out of spec with a total drop of .59V

The results will vary depending upon and the conditions of the cables. Both the positive and negative circuit results will be indicated from the single test. If the test does not pass, correct the connection or replace the cable and run the test again. The BCT-200J will automatically resume the test after it is disconnected. Just answer 'Yes' when prompted.

7 MAGNETIC CIRCUIT VDROPTM TEST

The Magnetic switch circuit supplies a path for current to the coils of the starter solenoid with minimum voltage drop. The Magnetic circuit is indicated by the dotted line on the illustration below. The Magnetic circuit test is designed to test the voltage drop of this circuit. It has three steps. If it passes the first test the whole circuit passes and there is no need to continue. If the first test fails, the next two tests are completed to obtain results of each leg and the magnetic switch itself. The Magnetic switch is energized by the ignition switch in each test. For safety, disconnect the negative cable from the battery.

Magnetic Circuit 3-Step Setup

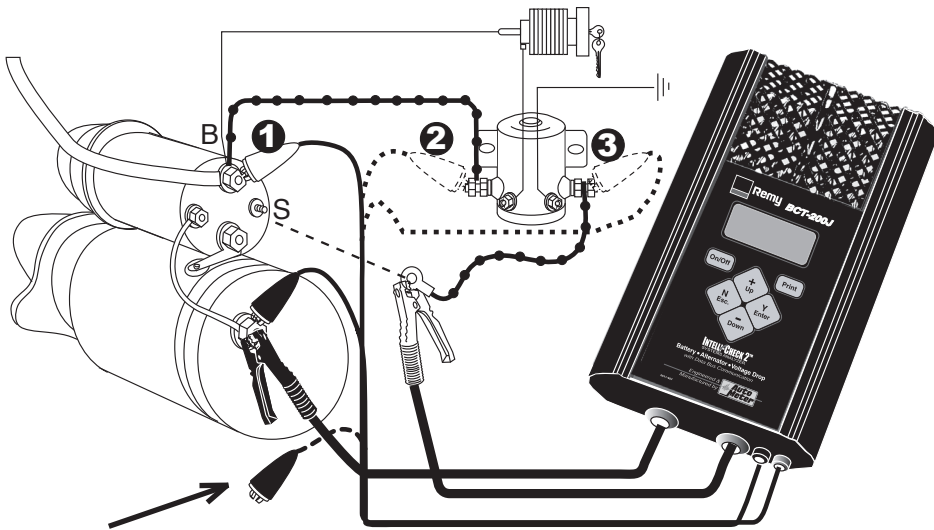

NOTE: ON 12 VOLT SYSTEMS THE SMALL BLACK LEAD CAN BE LEFT DISCONNECTED OR CAN BE CONNECTED TO ANY GROUND. ON 24 VOLT SYSTEMS THIS LEAD MUST BE CONNECTED TO THE STARTER GROUND.

```
CHARGING CABLES
STR MAIN CABLES
>MAG. CIRCUIT
LIFTGATE VDROPTM
```

This is a continuation of the Starting System Test, but can also be selected from the VDrop Menu by selecting >MAG. CIRCUIT then press Enter. In the individual test you will be asked to disconnect the Magnetic circuit from the "S" terminal on the starter solenoid as explained on the previous page. This is necessary to avoid starting the engine during this test sequence.

MAGNETIC CIRCUIT TEST (Cont.)

```
DISCONNECT THE
S-TERMINAL FROM
STARTER SOL.
'Y' TO CONTINUE
```

This is the small wire on the starter solenoid that activates the starter

```
SELECT STARTER TYPE.
STRAIGHT DRIVE/GEAR
REDUCTION
'Y' TO CONTINUE
```

Use the + / - key to select the type of starter you are testing.

```
>CONNECT LARGE
LEADS TO THE
S-TERMINAL/GND.
'Y' TO CONTINUE
```

Connect the large red clamp (+) to the disconnected ring from the S-terminal magnetic circuit. Connect the large black clamp (-) to the starter ground (See Illustration)

```
>CONNECT SMALL
LEADS TO THE
STARTER SOL/GND
'Y' TO CONTINUE
```

Connect the small red lead (+) to the 'B' terminal (+) of the starter solenoid. Attach the small black lead (-) to the starter ground (See Illustration - small clamp position 1)

```
>ENERGIZE THE
MAG SWITCH FOR
3-5 SECONDS.
'N' TO CANCEL
```

Reconnect the negative terminal on the battery. Then energize the Magnetic Switch for 3-5 seconds. Note. This can be done by a remote starter or by a second person turning the ignition.

```
LOADING
PLEASE WAIT...
```

Wait for results.

```
#337 MAG/CIRCUIT
PASSED!
DROP WITHIN SPEC
DROP @80A. 0.65V
```

If voltage drop is within specifications the whole circuit passes. This test should be done **THREE TIMES** when rotating contact magnetic switches are utilized.