

With PM Test
AGM Compatible

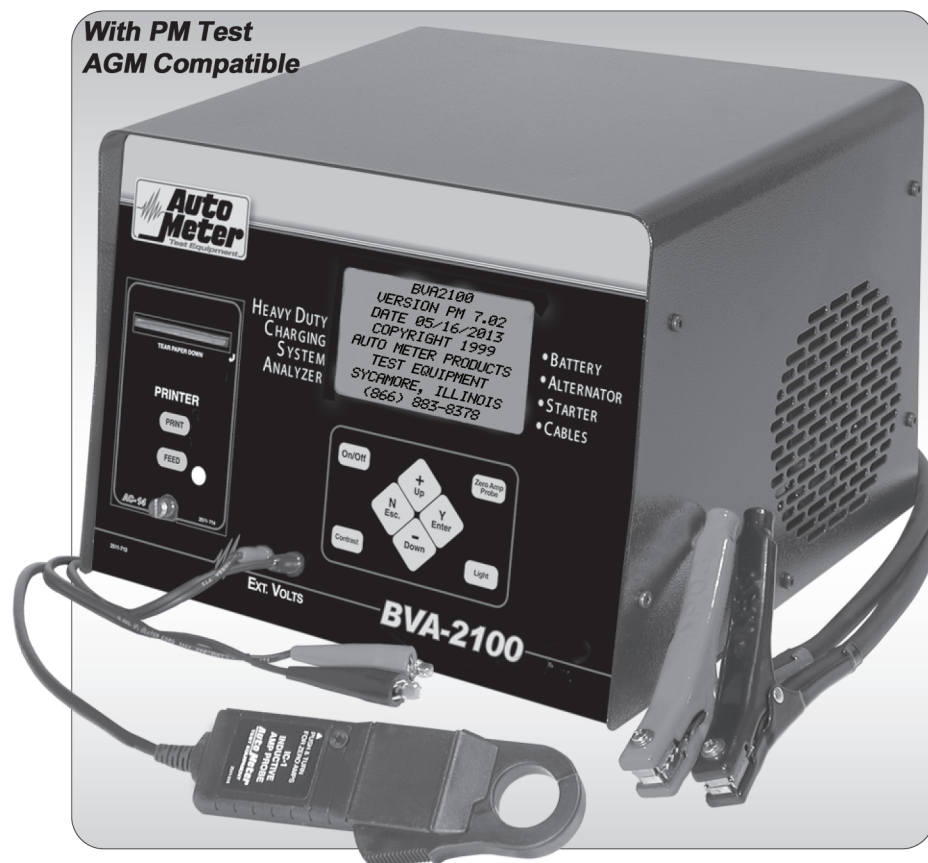

BVA-2100

Instruction Manual

Battery Load, Charging System, Starting System and Voltage Drop Tester for Light and Heavy-Duty Maintenance. Optional J1708 Hookup

Complement your battery testing with complete system test including a voltage drop test that measures the voltage drop of the starting and charging circuit. The BVA-2100 is automated and menu driven with simple hook-up methods for testing the negative and positive legs. Special tests are included for the magnetic switch circuit.

CONGRATULATIONS!

You have purchased one
of Auto Meter's Heavy Duty charging and starting system

analyzers. It is designed to test each circuit of a heavy duty or
automotive starting and charging circuits with speed and accuracy. If
you should have any questions about your tester or the testing
procedures please see back cover for contact information.



NOTES



BVA-2100

Test Capacity	500 Amp algorithmic load
Battery sizes	200-1600 CCA
Battery Voltages	6, 12, and 24 Volt
Charging System Voltages.....	12 Volt and 24 Volt
Starting System Voltages.....	12 Volt and 24 Volt
Graphic LCD w/ backlight	4.5" x 2.5"
Volt Ranges.....	Digital 0-40V
External Volt Rang	-40 to 40 Volts
Current Range	-1200 to 1200 Amps
Memory	Last 300 Tests
Internal Battery.....	6 V 7 Ah SLA
Cooling	Fan
Load Clamps.....	10 ft., 6 Gauge
External Leads	20ft 16 Gauge
Size	9.5" X 12" X 13"
Post Adapter Kit	For group 31 batteries
Optional AC-25.....	6 pin to 9 pin J1708 Adapter
Optional AC-26.....	J1708 Cable
Optional AC-14	Infrared printer
Optional AC-10	PC Interface adapter cord
Weight.....	25 lbs

What to Expect from the BVA-2100:

Immediately recognize a bad battery. Also perform a complete voltage drop test analysis on 12 and 24 Volt systems. Load test 6 and 12 Volt batteries and check 24 Volt batteries. Load 12 Volt and 24 Volt alternators. The BVA-2100 is a heavy-duty full-featured menu-driven battery tester and voltage drop tester that provides quick, professional load results using Auto Meter's advanced algorithmic load. The BVA-2100 has the option of using a J1708 cable. It is professionally accurate. Detailed test results are LCD displayed after each test and can be reviewed and printed from memory.



Specifications	2
Safety	4
Cause of Battery Failure.....	4
Inspection and Visual Check	5
Controls and Functions.....	6
Configuring the BVA-2100	7-9

Test Sections

1. PM Test	10
2. Battery Bank Test.....	11-12
3. Individual Battery Test.....	13-14
4. Charging System Test.....	15-19
5. Charging Cable VDrop Test	16-17
VDrop Error messages.....	17
6. Individual Alternator Test.....	18
Alternator Test Results.....	19
Using the Amp Probe	20
7. Starting System Test.....	21-28
8. Magnetic Circuit Test.....	22-24
9. Starting Cable VDrop Test	25-26
10. Individual Starter DrawTest.....	27
Starter Test Results.....	28
11. Liftgate & Generic VDrop Tests.....	29-30

Other Menu Options

Review Tests	31
<i>(Optional)</i> Printer.....	31-32
Printing Test Results	32
Multimeters	33
J1708 Data	34-35
Setup	36-37
Clearing Test and Setting Language	37
PC Download Interface.....	38
Using Windows.....	39
Downloading Test Information	40
Capturing Text in Microsoft Excel	40
About.....	41
Battery and VDrop Test System Specifications	42

SAFETY

- Carefully read all operating instructions before operating the BVA-2100
- Wear eye protection when working on batteries.
- Be sure each test is complete before removing load clamps to prevent arcing and potential explosion from battery gases. Never remove load clamps while testing. Keep sparks, flames or cigarettes away from battery.
- Keep hair, hands, and clothing as well as tester leads and cords away from moving blades and belt.
- Provide adequate ventilation to remove exhaust.
- In extremely cold temperatures check for frozen electrolyte fluid or swelled case before applying load. Do not attempt to Load Test or charge a battery under 20° F. (-7°C.). Allow the battery to warm to room temperature before testing or charging.
- **Warning!** Never attach the BVA-2100 to a battery connected to any other tester or charging unit. Damage may result.



NOTES



CAUSE OF BATTERY FAILURE

- **Incorrect Application:** Wrong size battery may have inadequate cold cranking rating for original vehicle specifications.
- **Incorrect Installation:** Loose battery hold-downs cause excessive vibration, which can result in damage to the plates.
- **Improper Maintenance:** Low electrolytic fluid and corrosion on battery connections can greatly reduce battery life and effect battery performance.
- **Internal Connections:** Make sure internal connections of entire charging system meet proper specifications.
- **Age of Battery:** If the date code on the battery is old, test failure may indicate the need of replacement.
- **Overcharging:** Overcharging caused by a high voltage regulator setting or incorrect battery charging can cause excessive gas, heat and water loss.
- **Undercharging:** Undercharging caused by a faulty charging system or low voltage regulator setting can cause lead sulfate to gradually build up and crystallize on the plates, greatly reducing the battery's capacity and ability to be recharged.
- **Cycling:** Excessive drain on battery when alternator is not operating.



1 YEAR FROM DATE OF PURCHASE CABLES 90 DAYS

The manufacturer warrants to the consumer that this product will be free from defects in material or workmanship for a period of one (1) year from the date of original purchase (90 Days for cables). Products that fail within this 1-year warranty period will be repaired or replaced at the manufacturer's option to the consumer when determined by the manufacturer that the product failed due to defects in material or workmanship. This warranty is limited to the repair or replacement of parts and the necessary labor by the manufacturer to effect the repair or replacement of the product. In no event shall the manufacturer be responsible for special, incidental or consequential damages or costs incurred due to the failure of this product.

Improper use, accident, water damage, abuse, unauthorized repairs or alterations voids this warranty. The manufacturer disclaims any liability or consequential damages due to breach of any written or implied warranty on its test equipment.

WARRANTY AND SERVICE INFORMATION

Warranty claims to the manufacturer's service department must be transportation prepaid and accompanied with dated proof of purchase. This warranty applies only to the original purchaser and is non-transferable. Shipper damage incurred during return shipments is not covered under this warranty. It is the responsibility of the shipper (the customer returning the Test Equipment) to package the tester properly to prevent any damage during return shipment. Repair costs for such damages will be charged back to shipper (customer returning the Test Equipment). Protect the product by shipping in the original carton. Add plenty of over-pack cushioning such as crumpled up newspaper.



Valid automotive electrical system testing depends on all the components being in good operating condition. In addition, the battery MUST have sufficient charge for testing. Carefully perform the following before attempting electrical diagnosis.

VISUAL CHECK

- **Inspect Battery** for terminal corrosion, loose broken posts, cracks in the case, loose hold-downs, low electrolyte level, moisture, and dirt around the terminal.

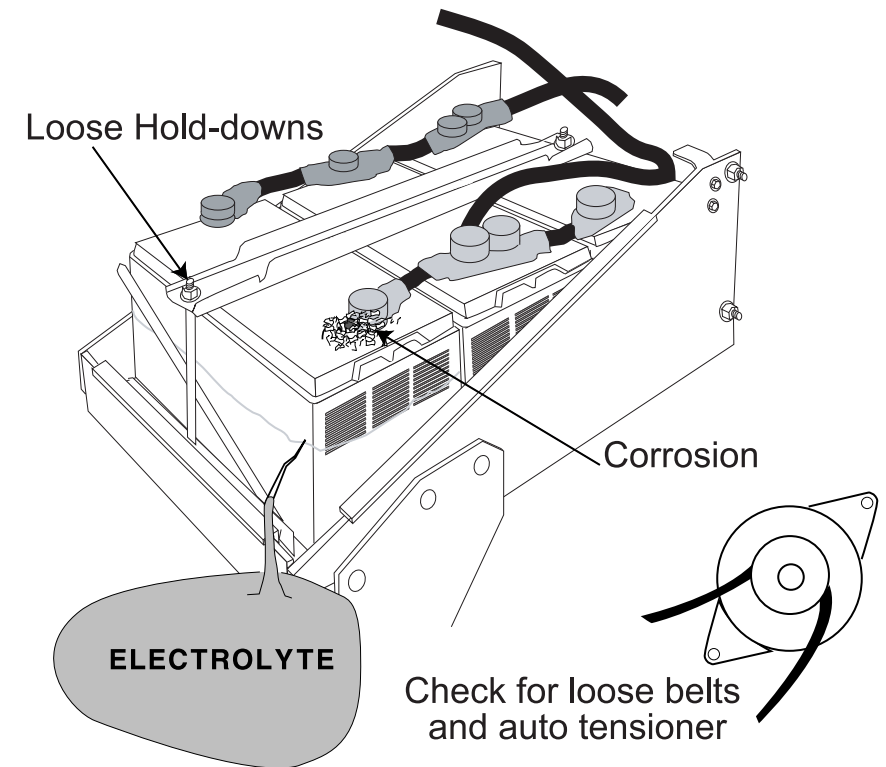

- **Important Note:** **A known defective battery must be replaced before proceeding with any test on the charging or starting system.**
- **Inspect Belts** for cracks, glazed surface and fraying. Tighten loose belts. Inspect auto-tensioner for proper belt tension.
- **Inspect Starting System.** Check starter, solenoid, and alternator for loose connections, loose mounts and frayed or cracked wires.

CONTROLS AND FUNCTIONS

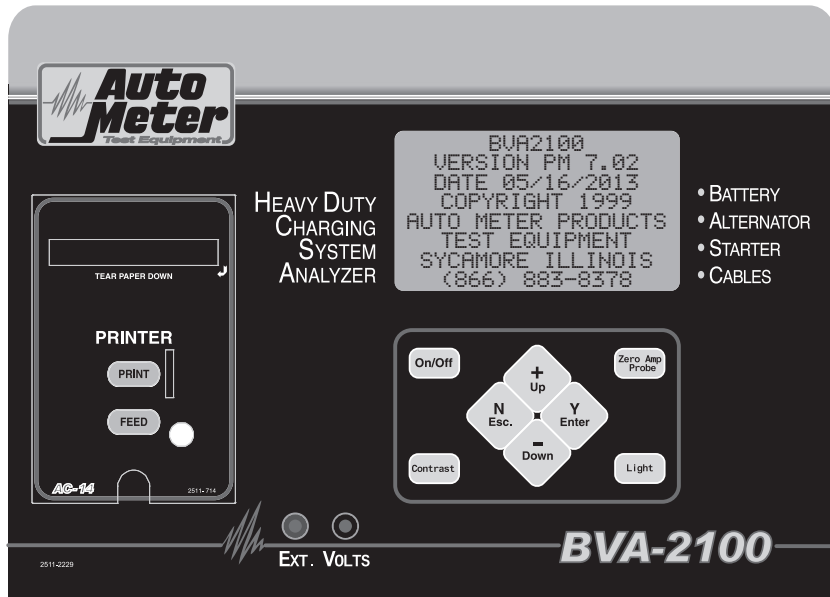

ON/OFF: Turns the unit and LCD display on. On the opening screen, Press 'Y' for menu.

Y ENTER: Selects the main or next menu. It also selects the cursor line item and answers yes to a test progression.

+Up Arrow: Moves the cursor up to select a menu item. It also increments a value.

-Down Arrow: Moves the cursor down to select a menu line. It also decrements a value.

N Esc: Cancels a test or progression. It also returns to a previous menu for another selection.

Contrast: Sets the LCD contrast.

Zero Amp Probe: Zero's the Amp Probe.

• BATTERY
• ALTERNATOR
• STARTER
• CABLES

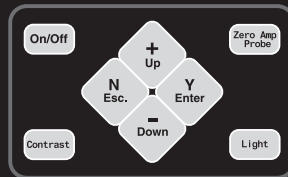

Light: Turns the LCD back light on or off.

PRINT: With Optional Printer - Prints the test results displayed on the LCD.

FEED: Advances the paper.

External Volt Lead Connections: Color-coded black (-) red (+)

On the rear panel there is an Amp Probe connection, power supply connection for charging the internal battery, when unit is not in use for some time, and the connector for the AC-26 J1708 cable.

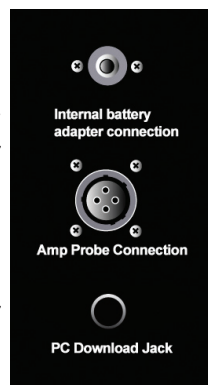

MAINTENANCE

CLAMP INSPECTION

IMPORTANT: Both jaws of each clamp must firmly engage all terminals. The copper jaw contains the smaller gauge wire that reads the voltage and the silver jaw contains the larger conducting wire that draws the load in each test. Jaw insulation is necessary for accurate readings. Damaged clamps or loose wires will affect the readings. Keep clamps clean and in good repair. **DO NOT ATTEMPT TO REPLACE CLAMPS WITH ANYTHING OTHER THAN AUTO METER CLAMPS.**

CHECK OFTEN FOR LOOSE JAWS OR DAMAGED INTERNAL PLASTIC SHOULDER INSULATORS

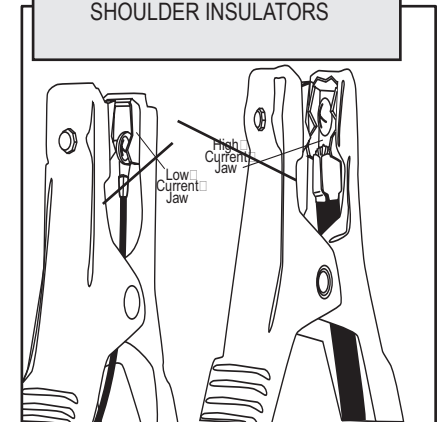

BATTERY CLAMP REPLACEMENT

Over time the battery clamps will need to be replaced if the following are indicated:

- CCA values seem to be way off.
- If there is continuity between the silver and copper jaw.
- If there is excessive damage or corrosion to the cables or clamps.

PROCEDURE

- Disconnect the back cover.
- Remove the battery to prevent shorting.
- Disconnect the two small wires from the PC board.
- Remove the large cables from the copper busses.
- Carefully pull each wire through the grommets.
- Reverse the procedure in replacing new clamps.
- **Caution:** Make sure the red clamp wires are attached to the positive buss and the black clamp is attached to the negative buss. Putting a little mineral spirits on the new cable ends will increase ease of insertion through the grommets.

INTERNAL 6V BATTERY

When the LCD indicates a low internal battery. Recharge the battery by either using the AC Adapter or connecting the large clamps to a fully charged 12V battery. To replace the internal battery, remove the top cover. The battery is towards the back of the unit. Disconnect the battery & remove the battery holder & battery. Replace with new 6V 7Ah SLA battery. Install battery & holder. Reconnect battery leads paying attention to the polarity. The - (minus) terminal should be connected to the folded black wire. Replace the top cover & charge the new battery before using.



BATTERY TEST

During each battery test the BVA-2100 uses various results that are displayed after each test. The definition of those results are as follows:

- **% Charge** = an approximate amount of charge the battery is currently holding. This is based upon the batteries voltage.
- **Est. CCA** = is the approximate CCA of the fully charged battery.
- **GOOD BATTERY** = a battery that is good and is charged.
- **GOOD NEEDS CHARGE** = a battery that is good but is low on charge.
- **MARGINAL BATTERY** = a battery that has passed the load test but the estimated CCA is getting low or the battery is approaching its end of life.
- **CHARGE and RETEST** = a battery with insufficient charge to provide accurate test results.
- **BAD BATTERY** = a battery that is bad and should be replaced. A bad battery is a battery that failed the load test or had an estimated CCA below about 70% of the rated value

There are several options in the setup program that make each test different depending upon the shops standards and desires. Depending upon the choices in configuration there will be additional input requests during each test. Below are the configuration choices of the BVA-2100 so you will know the options available even though they are not noted in each test of the manual. They are given here so that you can configure the tester for your needs before learning the operations. When a special LCD request appears that is not in the manual, you can refer to this section for better understanding.

VOLTAGE DROP TESTS

The specifications for those tests are listed below.

TEST	SYSTEM	PASS/FAIL
Charging Cables	12 Volt	Maximum drop at rated alternator output is 0.5 Volts
	24 Volt	Maximum drop at rated alternator output is 1.0 Volts
Main Starting Cables	12 Volt	Maximum drop at 500 Amps is 0.5 Volts
	24 Volt	Maximum drop at 250 Amps is 1.0 Volts
Magnetic Circuit Straight Drive	12 Volt	Maximum drop at 80 Amps is 1.0 Volts
	24 Volt	Maximum drop at 40 Amps is 2.0 Volts
Magnetic Circuit Gear Reduction	12 Volt	Maximum drop at 300 Amps is 1.0 Volts
	24 Volt	Maximum drop at 225 Amps is 2.0 Volts
Generic Voltage Drop Test	12 Volt	Reports the drops at the entered current
	24 Volt	Reports the drops at the entered current

The minimum system voltage to run a test is 12.25 Volts for a 12 Volt system and 24.5 Volts for a 24 Volt system.



From the main menu scroll to the bottom and select **SETUP MENU**



Then select **CONFIGURE TESTER**

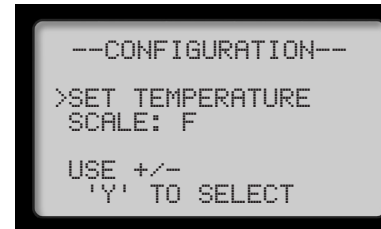

The first choice will be to set the temperature scale. Use the (Up) or (Down) key to adjust from F (Fahrenheit) or C (Celsius). The manual will be F.

CONFIGURING THE BVA-2100 (Cont.)

The following may be needed in fleet operations. The manual will assume NO in all cases. If you select YES, you will be asked to input the information or perform certain checks as requested in each test.



ABOUT

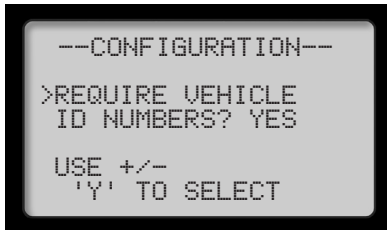

To require vehicle ID numbers select YES. The manual will assume NO.

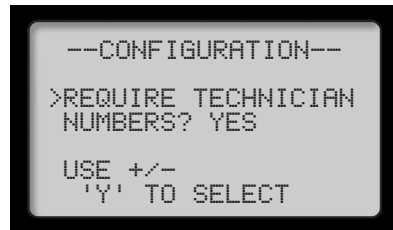

To require technician numbers select YES. The manual will assume NO.

When inputting numbers when required in each test, there will be a set of 0000. Use the (UP) or (Down) key to select the desired number for the first zero then press (ENTER) to advance to the next 2000.



To require visual checks select YES. The manual will assume NO. The visual checks, when required for a particular test, will request CHECKS before continuing such as:

INSPECT BELT CONDITION – TENSION
INSPECT CABLES AND ALTERNATOR OUTPUT
INSPECT BATTERY FOR DIRT, LEAKS OR CRACKS
INSPECT POSTS AND CONNECTIONS

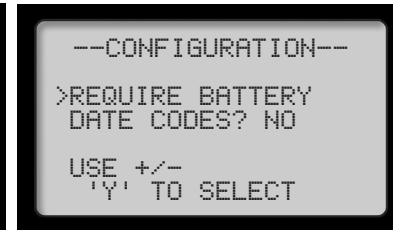

To require battery date code select YES. The manual will assume NO.

The date code has a letter for the month (A to M) and 01/00 for the day and the year. You have to increment each of these to the desired date that will print out in the standard 00/00 format.

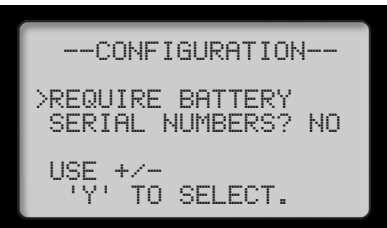

To require a battery serial number before each battery test select YES. The manual will assume NO. If YES is selected then before each battery test the tester will prompt for a 14 digit alpha-numeric serial number. This serial number will be printed near the bottom of the printout along with the warranty code.

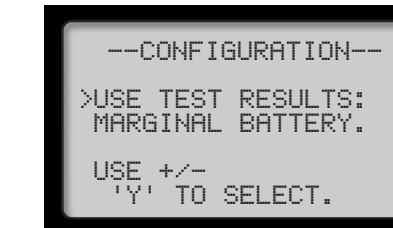

Select MARGINAL BATTERY to allow the test result to be MARGINAL BATTERY when a battery is close to being bad or select GOOD OR BAD ONLY to not allow marginal as a test result.



By selecting the last item on the main menu...



Gives the version of the software.



The program can be updated to the most recent version by reflashing the memory. Before turning the unit on hold the (N Exc.) and the (Y Enter) key down simultaneously. The following will appear.



When a computer can be attached to the unit in the same way the test data can be downloaded. "REFLASHING!" will then appear while the program is updating.

The Flash Upgrade Application software will be available from a CD or can be downloaded from our website. Contact Auto Meter for more information.



3. PC Screen Menu

- If the BVA-2100 is properly connected to your PC and the LCD shows "CONNECT ANALYZER TO A PC" the menu should automatically be displayed in Hyper Terminal.
- Press "1" to download the stored data.
 - To save the information displayed see "Capture text into Microsoft Excel." See BVA-2100 test labels below for identification.
 - Press "Enter" to return to Menu.
 - Press "Enter" to return to Menu.
 - Press "3" to Exit.

4. Capturing Text Using Microsoft Excel

For other software applications consult your software manual. Make sure menu is displayed as in step 3.

- Make sure menu is displayed as in step 3.
- Select "Capture Text" in the Transfer Menu.
- Type in **c:\my documents\download.txt** and then select "Start."
- Press "1" to download. When finished select Capture Text again from the Transfer Menu then select Stop.
- Launch Microsoft Excel and select open file.
- Under "Files of Type" at the bottom of the open file window select All Files (*.*)
- Highlight your "**download.txt**" file then select Open.
- Select "Delimited" and start at row 1 then "Next"
- Select "Comma" then "Next"
- Under Column Date Format select "General" then "Finish"
- After the file is loaded you can delete unwanted rows and format columns as desired. The following are labels for identifying the 8 columns of information.

12V Battery	Beginning Volts	Loaded Volts	Rated CCA	Est. CCA	Temperature	1ST CCA	Amb. Temp
6V Battery	Beginning Volts	Loaded Volts	Rated CCA	Est. CCA	Temperature	1ST CCA	Amb. Temp
24V Battery	Beginning Volts	N/A	N/A	N/A	Temperature	N/A	Amb. Temp
Battery Bank	Beginning Volts	Loaded Volts	Rated CCA	# of Batteries	Temperature	N/A	Amb. Temp
12V Alter. (Not HD)	Beginning Volts	Max Amps	Ripple	N/A	Average Amps	Rated Current	Ext Volts
24V Alter. (Not HD)	Beginning Volts	Max Amps	Ripple	N/A	Average Amps	Rated Current	Ext Volts
12V Alter. (HD)	Beginning Volts	Max Amps	Ripple	Peak Volts	Average Amps	Rated Current	R-Term
24V Alter. (HD)	Beginning Volts	Max Amps	Ripple	Peak Volts	Average Amps	Rated Current	R-Term
12V Starter (Not HD)	Beginning Volts	Loaded Volts	N/A	N/A	Cranking Volts	N/A	Draw
24V Starter (Not HD)	Beginning Volts	Loaded Volts	N/A	N/A	Cranking Volts	N/A	Draw
12V Starter (HD)	Beginning Volts	Loaded Volts	Ext Volts	Pos Drop	Cranking Volts	Pos Drop	Draw
24V Starter (HD)	Beginning Volts	Loaded Volts	Ext Volts	Pos Drop	Cranking Volts	Pos Drop	Draw
Charge Drop	Beginning Volts	Loaded Volts	Ext Volts	Pos Drop	Neg Drop	Rated Current	N/A
Start Drop	Beginning Volts	Loaded Volts	Ext Volts	Pos Drop	Neg Drop	N/A	N/A
Start Split Drop	Beginning Volts 2	Loaded Volts 2	Ext Volts 2	Pos Drop 2	Neg Drop 2	Amps 2	Beginning Volts 1
MAG. Cir.	Beginning Volts	Loaded Volts	Ext Volts	Pos Drop	Neg Drop	N/A	N/A
MAG. Por.	Beginning Volts	Loaded Volts	Ext Volts	Leg1 Drop	Mag Drop	Leg2 Drop	N/A
Generic Drop	Beginning Volts	Loaded Volts	Ext Volts	Pos Drop	Neg Drop	Rated Current	N/A

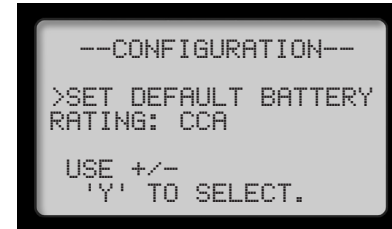

To set default battery rating select CCA, MCA, CA, EN, IEC, DIN, or NONE. The manual will assume CCA.

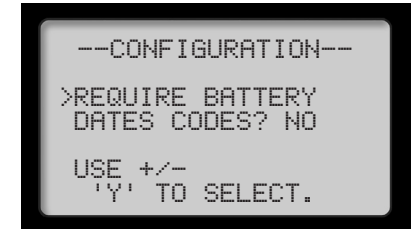

You can change the alternator regulation set points. Answer (NO) unless you are a skilled operator desiring different set point for your heavy duty operation. To change the alternator regulation set points the operator will have to enter an authorization code. The code is 009.

1 PM TEST



As mentioned in the configuration section above there is no appearance in this manual requesting the vehicle ID, technician ID etc. There are also no prompts to inspect components of the system. See the configuration section above for a better understanding if these items are required in your training. The PM Test should only be used during a time when the vehicle is in the shop for a PM service, NOT when the vehicle is having electrical system issues. For a vehicle with a suspected electrical problem use the individual tests starting with the batteries, then the cables, and finally the alternator or starter.

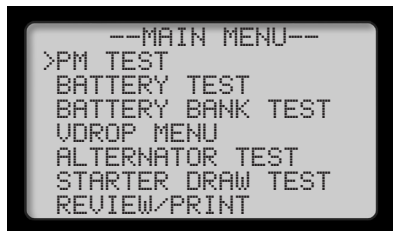

From the main menu select PM TEST.

The PM Test prompts for the number of batteries in the system; if the number of batteries is set to 1 then the PM Test will be geared towards automotive, if the number of batteries is set to 2 or more then the PM Test will be geared towards HD.

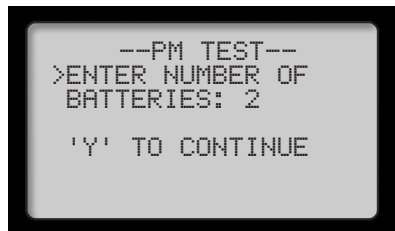

Follow the prompts to complete the PM Test. If the PM Test detects a problem use the individual tests to verify the issue. When using the individual tests always start by testing the batteries and do not continue on until the vehicle has a battery or battery bank that is good and fully charged. Once it has been verified that the battery or battery bank is good and fully charged then continue by testing the cables. Once the cables have been tested and repaired or replaced, then finally test the alternator or starter.

NOTE: When selecting PM Test, the BVA2100 will automatically run the battery test first to make sure the battery bank passes. Therefore, you need only use the battery bank test for testing the battery bank specifically.

USING WINDOWS 98/2000/NT/XP



Note: The BVA-2100 will interface with any basic (ANSI) terminal emulation software. Most operating systems contain a program that will do this. Following are instructions for Windows. For other operating systems consult the Manual for that system.

2. Opening Windows HyperTerminal:

- Select Windows Start
- Then "Programs"
- Then "Accessories"
- Then "Communications"
- Then Click "Hyper-Terminal"
- Double Click "Hypetrm.exe" application
- Type in a name for your connection
- Select an icon for future identification
- Select "OK"
- Select the COM port number you have previously identified in step 1.
- Select "OK" and select the following from the pull down menus:
 - Bits per second 9600
 - Data bits 8
 - Parity None
 - Stop Bits 1
 - Flow Control None
- Select "OK"

HyperTerminal Windows



BVA-2100 Test Labels

12V Battery	Beginning Volts	Loaded Volts	Rated CCA	Est. CCA	Temperature	1ST CCA	Amb. Temp	Date
6V Battery	Beginning Volts	Loaded Volts	Rated CCA	Est. CCA	Temperature	1ST CCA	Amb. Temp	Date
24V Battery	Beginning Volts	N/A	N/A	N/A	Temperature	N/A	Amb. Temp	Date
Battery Bank	Beginning Volts	Loaded Volts	Rated CCA	# of Batteries	Temperature	N/A	Amb. Temp	Date
12V Alter. (Not HD)	Beginning Volts	Max Amps	Ripple	N/A	Average Amps	Rated Current	Ext Volts	Pos V
24V Alter. (Not HD)	Beginning Volts	Max Amps	Ripple	N/A	Average Amps	Rated Current	Ext Volts	Pos V
12V Alter. (HD)	Beginning Volts	Max Amps	Ripple	Peak Volts	Average Amps	Rated Current	R-Term	Engin
24V Alter. (HD)	Beginning Volts	Max Amps	Ripple	Peak Volts	Average Amps	Rated Current	R-Term	Engin
12V Starter (Not HD)	Beginning Volts	Loaded Volts	N/A	N/A	Cranking Volts	N/A	Draw	N/A
24V Starter (Not HD)	Beginning Volts	Loaded Volts	N/A	N/A	Cranking Volts	N/A	Draw	N/A
12V Starter (HD)	Beginning Volts	Loaded Volts	Ext Volts	Pos Drop	Cranking Volts	Pos Drop	Draw	Oil Te
24V Starter (HD)	Beginning Volts	Loaded Volts	Ext Volts	Pos Drop	Cranking Volts	Pos Drop	Draw	Oil Te
Charge Drop	Beginning Volts	Loaded Volts	Ext Volts	Pos Drop	Neg Drop	Rated Current	N/A	N/A
Start Drop	Beginning Volts	Loaded Volts	Ext Volts	Pos Drop	Neg Drop	N/A	N/A	N/A
Start Split Drop	Beginning Volts 2	Loaded Volts 2	Ext Volts 2	Pos Drop 2	Neg Drop 2	Amps 2	Beginning Volts 1	Load
MAG, Cir.	Beginning Volts	Loaded Volts	Ext Volts	Pos Drop	Neg Drop	N/A	N/A	N/A
MAG, Por.	Beginning Volts	Loaded Volts	Ext Volts	Leg1 Drop	Mag Drop	Leg2 Drop	N/A	N/A
Generic Drop	Beginning Volts	Loaded Volts	Ext Volts	Pos Drop	Neg Drop	Rated Current	N/A	N/A

PC INTERFACE

1. Scroll down the main menu to DOWNLOAD. Press (Y Enter) to select.



```
STARTER DRAW TEST
REVIEW/PRINT
MULTIMETERS
J1708 DATA
HELP MENU
SETUP MENU
>DOWNLOAD
ABOUT BVA2100
```

Using Auto Meter's optional adapter cord AC-10 insert the plug into the jack on the BVA-2100 and then plug the serial adapter into a free serial port on your computer.

```
--DOWNLOAD--
>CONNECT ANALYZER
TO A PC
9600, N, 8, 1.
'N' TO CANCEL
```

Note: Most computers are configured with at least one serial port (identified as COM 1), and some have a second serial port, usually identified as (COM 2). Check your computer manual to locate and identify a serial port connector. Even if you have a physical COM port you need to make sure it is working properly before you proceed. Consult your computer manual. If your computer serial port is configured for 25 pin you will need to obtain an adapter from your computer store. If your computer does not have an available serial port and you're planning on using *Windows HYPER Terminal* as illustrated below, you will need to buy and install an adapter card with a serial port.



2 BATTERY BANK TEST



```
--MAIN MENU--
PM TEST
BATTERY BANK
>BATTERY BANK TEST
VDROP MENU
ALTERNATOR TEST
STARTED DRAW TEST
REVIEW/PRINT
```

```
--BATTERY BANK--
>ENTER NUMBER OF
BATTERIES: 2
'Y' TO CONTINUE
```

You will be asked to enter the number of batteries in the system. The number selected in the last test will appear. Simply use the (+) or (-) key to select the correct number. Then press ('Y' Enter) to continue.

```
--BATTERY BANK--
>DOES VEHICLE HAVE
J1708 DATA PORT?
'N' OR 'Y'
```

You will be asked if the vehicle has a J1708 data port. Answer Yes or No. Except in this case all tests will assume no. For more information see page 33.

```
--BATTERY BANK--
>ATTACH J1708 DATA
CABLE.
'N' TO CANCEL
```

Attach the Optional J1708 Data Cable. If the cable is not correctly attached the test will not continue. Check the connection at the tester and the vehicle.

```
--BATTERY BANK--
>TURN IGNITION KEY
TO RUN.
'N' TO CANCEL
```

Turn on ignition key to run transfer of data.

J1708 connection is usually under the dash or left of the drivers seat on the floor.



BATTERY BANK (Cont.)

```

--BATTERY BANK--
>VIN: 123456789A
BATTERY 12.65V.
OIL TEMP 68F

'Y' TO CONTINUE
    
```

The vehicles data will appear. Much of the information accessed, such as the oil temperature will be use in the calculating test results. Press (Y Enter).

```

--BATTERY BANK--
>CONNECT LARGE
LEADS TO THE
BATTERY BANK

'Y' TO CONTINUE
    
```

You will be instructed to connect the large leads. Connect the red clamp to the main positive cable coming to the bank and the black clamp to the main negative cable leaving the bank.

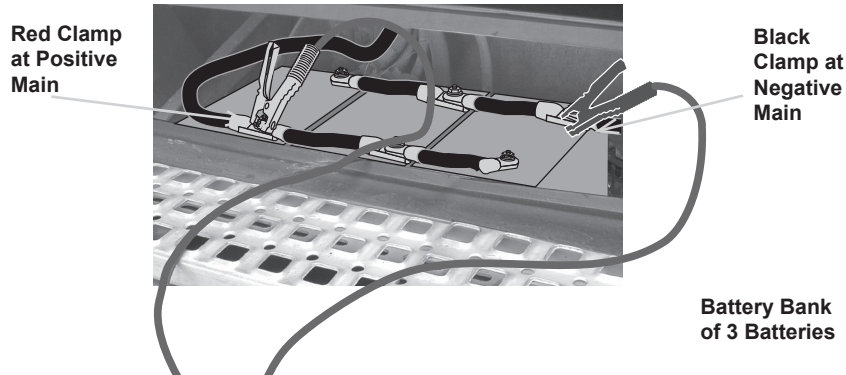

```

--BATTERY BANK--
>ENTER BATTERY
TEMP. 70F.
12.39V

'Y' TO CONTINUE
    
```

Using the (+) or (-) key adjust the temperature in units of 10 degrees. This should be the temperature of the battery(S). Consider where the vehicle has been before adjusting.

```

--BATTERY BANK--
>ENTER SINGLE
CCA 650
12.39V

'Y' TO BEGIN
    
```

Using the (+) or (-) key adjust the CCA of an individual battery. If each battery varies in CCA approximate an average. If the CCA is unknown consider that most truck batteries range from 625-950 CCA.

```

--BATTERY BANK--
>TESTING BANK
PLEASE WAIT...
    
```

Press (Y Enter) to begin the test and wait for results. Example is at the top of page 10 (Individual Batter Test).

CLEARING TESTS AND SETTING LANGUAGE

```

--SETUP MENU--
CONFIGURE TESTER
SET DATE & TIME
>CLEAR LAST TEST
CLEAR ALL TESTS
SET LANGUAGE
    
```

Select CLEAR LAST TEST from memory. You will be asked to verify your selection after which the BVA-2100 will clear the last test.

```

--SETUP MENU--
CONFIGURE TESTER
SET DATE & TIME
CLEAR LAST TEST
>CLEAR ALL TESTS
SET LANGUAGE
    
```

Select CLEAR ALL TESTS from memory. You will be asked to verify your selection after which the BVA-2100 will clear the last test.

```

--SETUP MENU--
CONFIGURE TESTER
SET DATE & TIME
CLEAR LAST TEST
CLEAR ALL TESTS
>SET LANGUAGE
    
```

You can set for English or Spanish

```

--LANGUAGE--
>SELECT LANGUAGE:
ENGLISH.

USE +/-,
'Y' TO SELECT.
    
```

SETUP MENU



```
--SETUP MENU--
CONFIGURE TESTER
>SET DATE & TIME
CLEAR LAST TEST
CLEAR ALL TESTS
SET LANGUAGE
```

From the main menu select **SETUP MENU**. The first selection was covered on page 7 and 8. This section will cover setting the time and date.

```
--SET DATE/TIME--
01/01/06 12:00AM
>CHANGE THE TIME?

'N' OR 'Y'
```

If you select Yes you can change the MONTH, DAY, YEAR, HOUR and MINUTE.

```
--SET DATE/TIME--
>SET MONTH: 01

'Y' TO CONTINUE
```

Select the month as 01 to 12 by using the (+Up) or (-Down) key then press enter

```
--SET DATE/TIME--
>SET DAY: 01

'Y' TO CONTINUE
```

Select the day as 01 to 31

```
--SET DATE/TIME--
>SET YEAR: 13

'Y' TO CONTINUE
```

Select the year as 04 to 99

```
--SET DATE/TIME--
>SET HOUR: 11 AM

'Y' TO CONTINUE
```

Select the hour as 01 to 12 AM/PM

```
--SET DATE/TIME--
>SET MINUTE: 57

'Y' TO CONTINUE
```

Select the minute as 01 to 60

3

INDIVIDUAL BATTERY TEST



```
#211 12V BANK
12/24/12 09:57AM
GOOD BATTERIES
12.70V CHARG 100%
NO. OF BATTERIES 2
```

When the test results appear as **GOOD BATTERIES** after running the system battery bank test there is no need to run the individual battery test. Press (Y Enter) to return to menu.

```
#211 12V BANK
12/24/12 09:57AM
TEST SEPERATELY
12.70V CHARG 100%
NO. OF BATTERIES 2
```

If the battery bank test results are low you will be instructed to test each battery separately.

```
--MAIN MENU--
PM TEST
>BATTERY TEST
BATTERY BANK TEST
VDROP MENU
ALTERNATOR TEST
STARTER DRAW TEST
REVIEW/PRINT
```

You can select **BATTERY TEST** from the main menu.

Note! When testing batteries individually each battery should be disconnected. Avoid improper results and damage to the posts by using the included post adapters on threaded post batteries. If the configuration was set to prompt inspection the LCD will display the instruction.

```
--BATTERY TEST--
>CONNECT LARGE
LEADS TO THE
BATTERY

'Y' TO CONTINUE
```

Connect the large red clamp to the positive and the large black to the negative battery terminal. If the clamps are connected improperly you will be prompted to correct the problem. The tester will then revert back to the beginning or main menu. Be sure to use post adapters on threaded steel posts as illustrated on the next page then press (Y Enter).

```
--BATTERY TEST--
>INSPECT BATTERY
FOR DIRT, LEAKS
OR CRACKS

'Y' TO CONTINUE
```

The prompt and others appear only if the user has configured to do so in **SETUP**. The same applies to entering the battery date code. [See page 7.](#)

INDIVIDUAL BATTERY TEST (Cont.)



Use Post Adapters

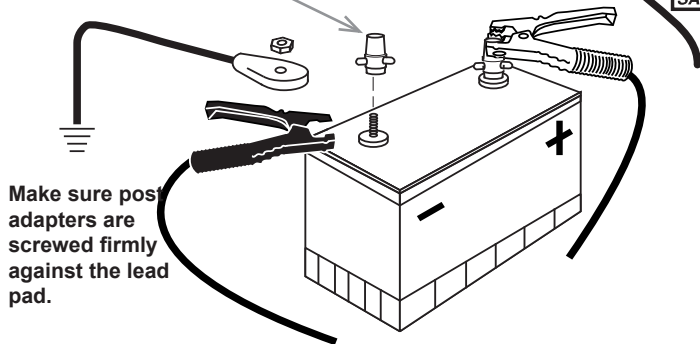

Make sure post adapters are screwed firmly against the lead pad.

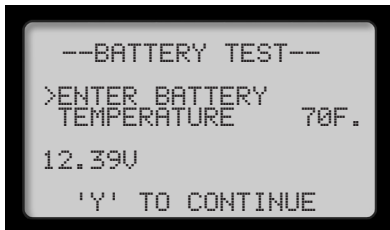

Using the (+) or (-) key adjust the temperature in units of 10 degrees. This should be the temperature of the battery.

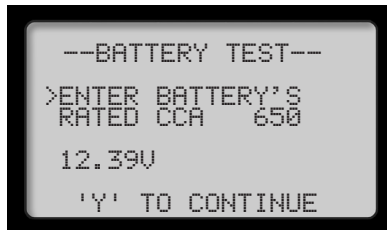

Using the (+) or (-) key adjust the CCA of the battery. Press (Y Enter) to begin test.

The tester will prompt to select either LOAD TEST or CAPACITY TEST. Select LOAD TEST for batteries that are used for starting application and select CAPACITY TEST for batteries that are used for starting and/or extensive auxiliary loads. The load test takes 15 seconds to perform and the capacity test takes up to 4 minutes and consists of load and rest periods.

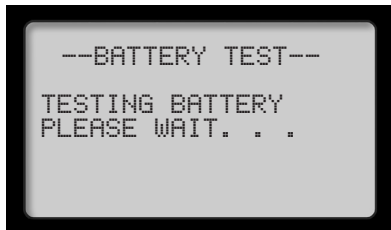

Wait for results.

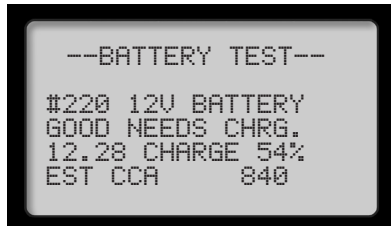

There are five test results:
GOOD BATTERY
MARGINAL BATTERY
BAD BATTERY
GOOD NEEDS CHARG.
CHARGE AND RETEST

J1708 DATA (Cont.)



This gives the user a chance to check the J1708 connections and obtain pertinent information such as the ambient temperature for later use in testing the battery. Keep in mind that the ambient temperature may not be the actual temperature of the battery unless the vehicle battery has been in the place sufficient time for the battery to reach the surrounding ambient temperature. A low oil temperature would add a greater demand on the starter. This information is used by the BVA-2100 to calculate the condition of the starter.

Each test throughout the manual does not include the sequence for the J1708 cable attachment. The only exception is the battery bank test. Each menu sequence will, however, include the following:



You will be asked if the vehicle has a J1708 data port. Answer Yes or No.

If you answer yes you will be asked to attach the J1708 cable to the receptacle under the dash or on the floor near the drivers seat as illustrated on page 33.

HELP MENU



From the main menu SCROLL DOWN TO HELP MENU and press (Y Enter)

The following help selection will be listed adding valuable information not necessarily in manual:

GENERAL INFORMATION
SYSTEM TESTING
BATTERY TESTING
VOLTAGE DROP TESTING
CHARGING CABLES VDROPTESTING
MAG. CIRCUIT VDROPTESTING
GENERIC VDROPTESTING
ALTERNATOR TESTING

STARTER TESTING
REVIEWING AND PRINTING
USING THE MULTIMETERS
J1708 DATA
SETTING UP THE BVA 2100
DOWNLOADING STORED DATA



```

--MAIN MENU--
BATTERY BANK TEST
UDROP MENU
ALTERNATOR TEST
STARTER DRAW TEST
REVIEW/PRINT
MULTIMETERS
>J1708 DATA
    
```

Select J1708 Data from the main menu. You will need to press (-Down) to scroll to the selection. The arrows to the right indicate directions they can be scrolled. Press (Y Enter) to make the selection.

```

--J1708 DATA--
>ATTACH J1708 DATA
CABLE.
'N' TO CANCEL
    
```

Attach the Optional J1708 Data Cable. If the cable is not correctly attached the test will not continue. Check the connection at the tester and the vehicle.



Turn on ignition key to run transfer of data.

```

--J1708 DATA--
>TURN IGNITION KEY
TO RUN.
'N' TO CANCEL
    
```

The vehicles data will appear. Much of the information accessed, such as the oil temperature will be used in the calculation of the test results. Press (Y Enter).

```

--J1708 DATA--
VIN: 123456789A
BATTERY 12.65V.
OIL TEMP 68F
    
```

```

--J1708 DATA--
ERROR:
J1708 NOT READING.
    
```

If ERROR appears the connections has not been established.



The charging system consists of 1. the battery or battery bank, 2. the cables from the battery to the alternator and 3. the alternator. The proper sequence for testing the charging system is to begin with the battery or battery bank and then once the battery or battery bank is confirmed to be good and charged then the cables should be tested and finally after the cables have been confirmed to be good the alternator should be tested. If this sequence is not followed or if the alternator is tested with batteries that are low or bad or if the cables are weak the alternator could be misdiagnosed.

The previous sections explain the battery and battery bank tests and the next couple of sections explain the charging cable test and the alternator test.

5

CHARGING SYSTEM VDROP TEST

MULTIMETERS

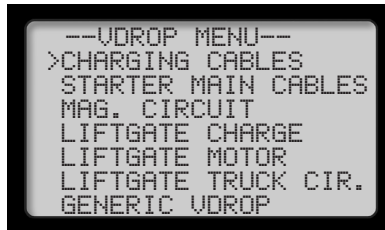
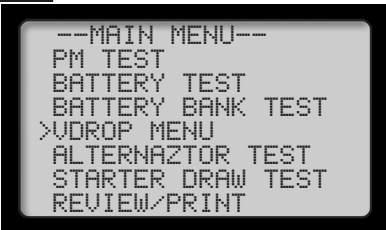

The individual charging voltage drop test can also be selected from the main menu

... followed by a selection of Charging Cables.

You will be asked for the alternator rating and instructed to connect the large clamps to the alternator as in the charging system test.

ALTERNATOR HOOKUP

Red to Positive

Black to Ground

Connect the small leads to the battery bank - the red on the positive main and the black on the negative main and not to an individual battery. The added small external leads will check the cables before the alternator is tested. This is the individual VDrop Test.

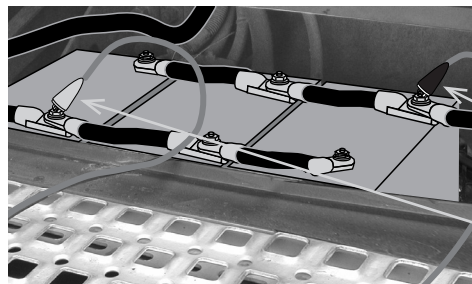
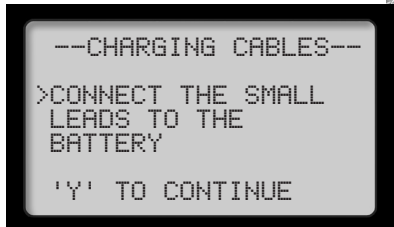
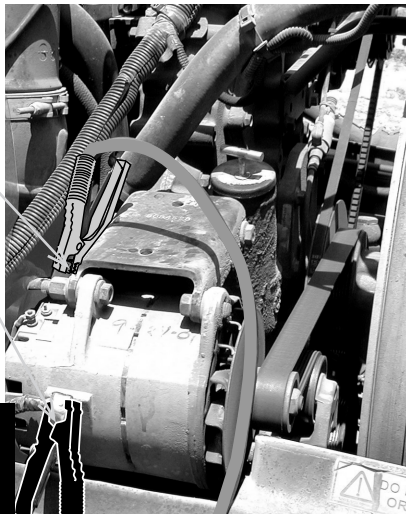

Black Clamp at Negative Main **BATTERY HOOKUP**

Red Clamp at Positive Main

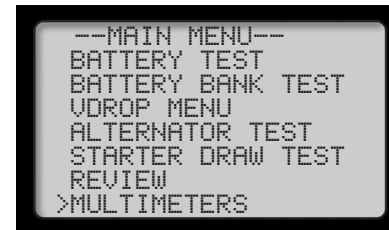

Select MULTI METER from the main menu and press (Y Enter).

This gives the user a chance to compare the voltage from the large clamps and the external leads.

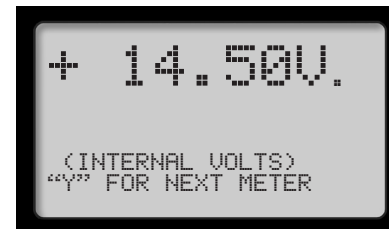

The first display gives the internal volts.

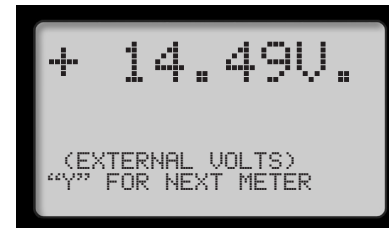

Press (Y Enter) and for the external volts.

Note: The Amps are displayed only if the Amp Probe is connected.

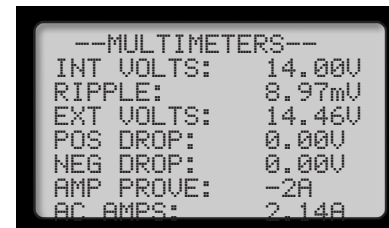

Press (Y Enter) again for an extended menu results. Again, the Amps are only displayed if the Amp Probe is connected.

Manual Print Operation

Press (PRINT) to obtain a printout. This is done after each finished test or during REVIEW.

Note: Tear printouts down to provide even separation and avoid jamming.

When using one of Auto Meter's handheld testers, the AC-14 Prints from up to 15 ft. away by means of an infrared receiver.

Changing Paper:

1. Disconnect clamps from any battery.
2. Unplug the AC cord.
3. Loosen the thumbscrew at the bottom of the printer.
4. Carefully remove the cover.
5. Replace the new paper roll by feeding it under the roll and over the PC board as illustrated. Press the FEED button to check the advance of the paper.
6. It is best NOT to disconnect the ribbon cable, but if for any reason you do disconnect the ribbon cable make sure the top edge of the ribbon cable attached to the BVA-2100 is also correctly aligned with the top of the printer. Do not twist the ribbon cable. Make sure the pins are aligned properly. Do not force, but make sure the connection is solid.
7. Reinstall printer by inserting the top tab under the panel and tightening the thumbscrew. Be careful not to damage the printer ribbon cable.

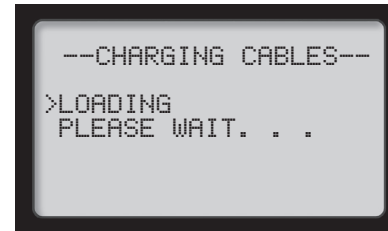
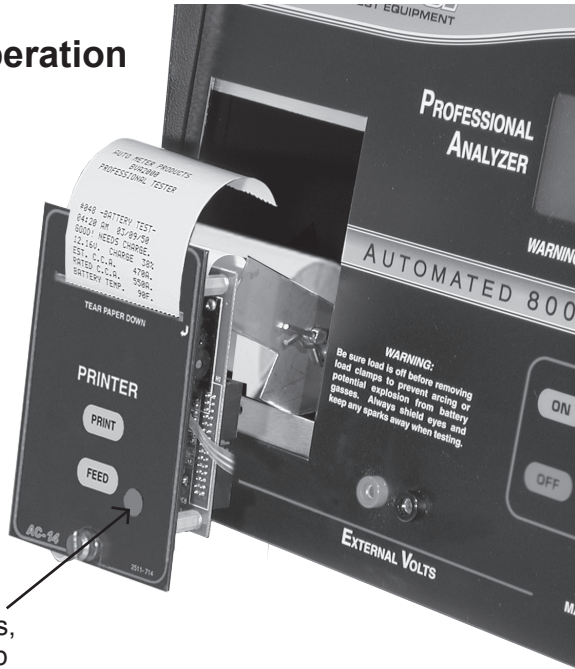

If all connections are correct press (y Enter) to begin VDrop Test. Wait for a load to be applied. The results will vary depending upon the conditions of the cables. The test will either pass or fail. If it fails, you will be asked to correct the condition before testing the alternator

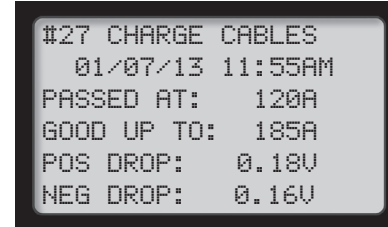

Both the positive and negative circuit results will be indicated. If the test does not pass, correct the connection or replace the cable and run the test again. The BVA 2100 will automatically resume the test after it is disconnected. Just answer 'YES' when prompted.

VDROP ERROR MESSAGES

One of the following may appear during any drop test sequence. Correct the situation before continuing.

- LARGE LEADS NOT CONNECTED
- BAD CONNECTION ON LARGE LEADS
- SMALL LEADS REVERSED
- SMALL LEADS NOT CONNECTED
- CHECK LARGE RED LEAD
- CHECK LARGE BLACK LEAD
- TURN OFF ENGINE AND ACCESSORIES

System noise indicates some device is turned on. Correct by turning vehicle loads off before continuing.

- ELECTRICAL SHORT OR ACCESORY DRAW

Check tester connection and make sure vehicle loads are off.

Once the VDrop Test is complete and the cables have passed the test, the CHARGING SYSTEM TEST will finalize with the ALTERNATOR TEST starting on page 17.

6

INDIVIDUAL ALTERNATOR TEST

REVIEW



If the battery bank and the charging main cables pass then the Charging System Test will take you to the individual Alternator Test.

```
--PM MENU--
PM TEST
BATTERY TEST
BATTERY BANK TEST
VDROP MENU
>ALTERNATOR TEST
STARTER DRAW TEST
REVIEW/REVIEW
```

This test can also be selected from the main menu by selecting Alternator Test then press (Y Enter).



If the unit is setup to require visual checks you will be asked to inspect belt condition and tension. Also, if this is an individual alternator test and not part of the CHARGING SYSTEM test you will be asked to enter the alternator rating

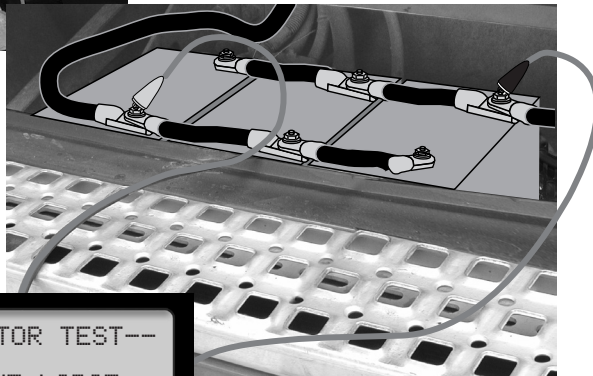

```
--ALTERNATOR TEST--
>CONNECT THE LARGE
LEADS TO THE
BATTERY.

'Y' TO CONTINUE.
```

If the Amp Probe is attached to the tester you will be asked to ZERO the probe and attach it to the Alternator output. The test will run without the Amp Probe, but is considered to be slightly more accurate if the probe is used. See page 19 for instructions regarding the Amp Probe.

```
--MAIN MENU--
PM TEST
BATTERY TEST
BATTERY BANK TEST
VDROP MENU
ALTERNATOR TEST
STARTER DRAW TEST
>REVIEW/PRINT
```

From the main menu select REVIEW.

```
#27 CHARGE CABLES
07/05/12 05:58PM
PASSED AT: 120A
GOOD UP TO: 185A
POS DROP: 0.18V
NEG DROP: 0.16V
```

The last test will be displayed exactly as it was displayed after the test was made

Press (+Up) or (-Down) key to increment or decrement to the desired test. The last 150 tests are held in memory. The same tests can be downloaded to a PC. See the Download section for more information. Press (N Esc.) to return to menu.

Press PRINT and the optional printer will print the test displayed on the LCD.

Sample.

```
Auto Meter Products
BVA-2100
PROFESSIONAL TESTER

RK Automotive
819 Palisade Rd.
Anywhere USA

#099 -LOAD TEST-
07/03/12 10:23AM
PASSED! GOOD BATTERY
EXPECTED LIFE = LONG
EST. C.C.A. 620A.
RATED C.C.A. 625A.
12.60V. CHARGE 91%
LOADED VOLTS 10.16V.

SERIAL NUMBER:
X1234567890123

WARRANTY CODE
2BC0813280B012H12
```

For battery, starter, and alternator tests a unique warranty code is generated and printed at the bottom of the printout. This code is used for data and warranty verification.



```
--GENERIC VDROP--
>CONNECT THE SMALL
CLIPS TO THE
BATTERY.

'Y' TO BEGIN.
```

Then connect small leads to the battery and press (Y Enter).

```
--GENERIC VDROP--
>LOADING
PLEASE WAIT. . .
```

If all connections are correct, wait for a load to be applied.

```
#28 GENERIC VDROP
07/05/12 05:45PM
RATED CURRENT: 500A
POS DROP: 0.20V
NEG DROP: 0.45VA
```

The results will vary depending upon and the conditions of the cables. Both the positive and negative circuit results will be indicated from the single test.

```
--VDROP MENU--
CHARGING CABLES
STARTER MAIN CABLES
MAG. CIRCUIT
>LIFTGATE CHARGE
LIFTGATE MOTOR
LIFTGATE TRUCK CIR.
GENERIC VDROP
```

Select LIFTGATE CHARGE, LIFTGATE MOTOR or LIFTGATE TRUCK CIR. to perform a voltage drop test on the trailer charge circuit, trailer liftgate motor circuit or the truck's liftgate power circuit respectively.

If the overall voltage drop is not within the desired specifications the small leads can be moved closer along the line being tested and the test run again (see dotted lead on previous page). If the results are desirable, it is the section not included in the last test. If the results are not desirable the problem is most likely in the section being tested. Repair and test the entire section again.

The liftgate charging circuit includes the positive cables from the front of the trailer to the liftgate batteries and the negative cables and/or frame from the front of the trailer to the liftgate batteries.

The liftgate motor circuit includes the positive cables and the solenoid from the liftgate batteries to the liftgate motor and the negative cables and/or from the liftgate batteries to the liftgate motor.

The liftgate truck circuit includes the positive cables and the negative cables and/or frame from the trucks batteries to the front of the trailer (end of the "stinger" cord).

Adapters are available from Auto Meter to facilitate connecting the BVA-2100 to single pole and dual pole connectors on both trucks and trailers. See the manual supplement that is included with those adapters for more detailed information on testing and trouble shooting the liftgate charging circuits and liftgate motor circuits.



```
--ALTERNATOR TEST--
>START ENGINE, IDLE
AT ABOUT 1000 RPM.

12.73V

'Y' TO CONTINUE.
```

Start Engine

```
--ALTERNATOR TEST--
>ALLOW VOLTAGE TO
STABILIZE.

12.73V

'Y' TO BEGIN.
```

Allow voltage to stabilize until it stops rising. Press (Y Enter) to begin.

```
--ALTERNATOR TEST--
>TESTING ALTERNATOR
5 SECONDS.

12.61V +0000 A
PLEASE WAIT. . .
```

Wait for test . . .

```
--ALTERNATOR TEST--
>REV ENGINE TO GOV.
SPEED FOR 10 S.

12.61V +000 A

'N' TO CANCEL.
```

Rev the engine to governed speed for 10 seconds. If no results appear press (Y Enter).

```
--ALTERNATOR TEST--
>TESTING ALTERNATOR
5 SECONDS.

12.61V +0000 A
PLEASE WAIT. . .
```

If a reved engine is not detected, the test will assume a governed speed.

```
--ALTERNATOR TEST--
>REV ENGINE TO GOV.
SPEED FOR 10 S.

12.61V +000 A

'N' TO CANCEL.
```

The test result will appear.

The following are test result samples:

- LOW REGULATION, BAD DIODE, LOW OUTPUT
- HIGH REG, BAD DIODE, PARTIAL OUTPUT
- LOW REG, LOW OUTPUT
- HIGH REG, GOOD DIODES, LOW OUTPUT

USING THE AMP PROBE



The Amp Probe is optional and can be used in the Alternator and the Starter Draw Test whether they are individual tests or within each of the system tests. The Amp Probe can also be used in the Multimeters test. This section explains the proper use of the Amp Probe, but is not required to run any of the tests. It only provides assured accuracy for those wanting these results.

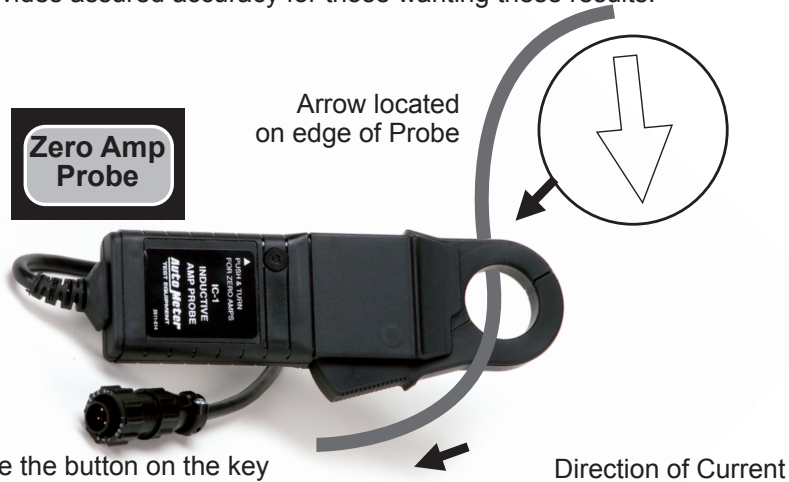

Use the button on the key pad to zero the Amp Probe in the Alternator and Starter Draw tests you will have two additional menu options if the AMP Probe is attached on the rear of the tester. If the menus do not appear the Amp Probe is not attached properly.

The following are examples of use within a test sequence.



You will first be asked to zero out the Probe. Pressing the "Zero Amp Probe" on the keypad. Instead of +00003 A, it should read +00000 A.



You will then be asked to attach the probe to a particular wire such as alternator output or starter cable.

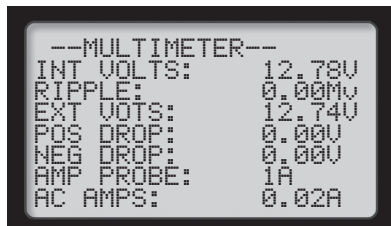

In the multimeters test the bottom two lines will not appear if the Amp Probe is not connected. In other test results there may be slightly different displays.

11 LIFTEGATE & GENERIC VDRO



Generic System Setup

The various liftgate circuit voltage drop tests and the generic voltage drop test can be used to test the liftgate charging and motor circuits as well as any other circuit that includes a battery and cables and is designed to operate a load of 20 amps or more.

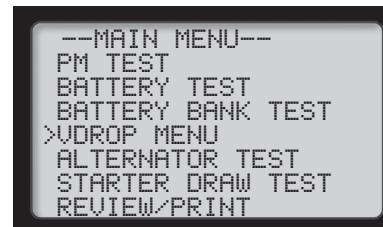
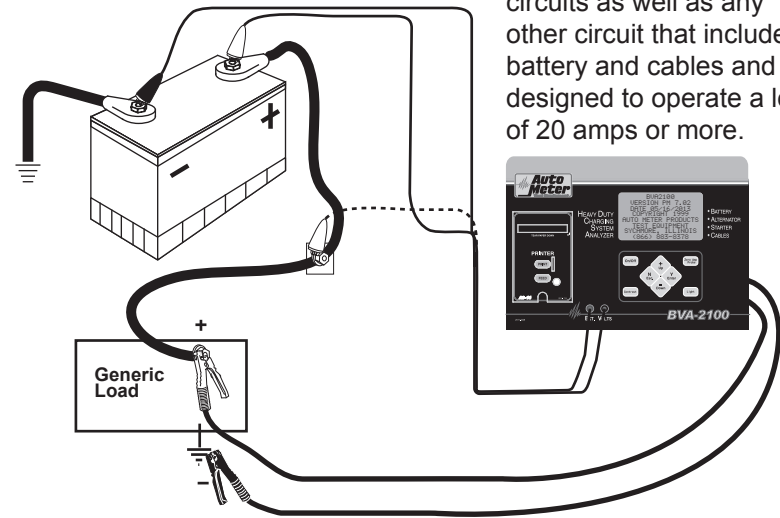

Select VDRO MENU and press (Y Enter).

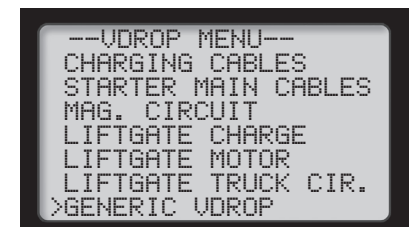

...select >GENERIC V DRO and press (Y Enter).

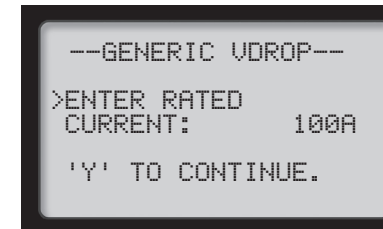

Using the (+/-) key adjust Amp rating to that of the generic load device.

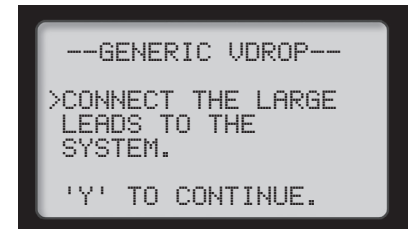

Connect large leads to the generic load.



```
#216 12V STARTER
07/05/12 05:45PM
NORMAL DRAW
OIL TEMP: 58F
CURRENT: 640A
CRANK TIME: 1.24S
```

```
#217 12 STARTER
07/05/12 05:47PM
NORMAL DRAW
OIL TEMP: 58F
CURRENT: 640A
CRANK TIME: 2.24S
```

There are 2 results with J1708

```
#218 12V STARTER
07/05/12 05:52PM
BEG VOLTS: 12.56
END VOLTS: 9.48
CURRENT: 860A
CRANK TIME: 1.68S
```

Results without J1708

If the results are out of specification do the following:

- Inspect the connectors for excessive voltage drop.
- Repair or replace any defective cables or connectors.
- Retest the system.

If still out of specifications: **High** Amp reading may indicate engine is out of time or a faulty starter. Some possible causes are shorted windings, bent armature, broken housing or bad bearings. Repair or replace starter as needed.

STARTER DRAW AND DIESEL ENGINES

There are a few points to consider in testing a starter on a diesel engine. The BVA-2100 is designed to recognize any significant amount of draw; this includes glow plugs in small diesel engines. In heavy-duty applications consider computer and accessory draw.

- Make sure you start the engine quickly. The engine should be warm.
- Turn the ignition on and allow the glow plugs to heat up and click off before you run the Starter Draw Test. This could be done at the time the Amp Probe is attached.
- Repeat the test in different ways and compare results.



The starting system consists of 1. the battery or battery bank, 2. the main cables from the battery to the starter, 3. the magnetic (solenoid) circuit and 4. the starter. The proper sequence for testing the starting system is to begin with the battery or battery bank and then once the battery or battery bank is confirmed to be good and charged then the cables and magnetic circuit should be tested and finally after the cables have been confirmed to be good the starter should be tested. If this sequence is not followed or if the starter is tested with batteries that are low or bad or if the cables are weak the starter could be misdiagnosed.

Sections 2 and 3 explain the battery and battery bank tests and the next few sections explain the starting main cable test, the magnetic circuit test and the starter test.

8 INDIVIDUAL MAGNETIC CIRCUIT TEST

The Magnetic switch circuit supplies a path for current to the coils of the starter solenoid with minimum voltage drop. The Magnetic circuit is indicated by the dotted line on the illustration below. The Magnetic circuit test is designed to test the voltage drop of this circuit. It has three steps. If it passes the first test the whole circuit passes and there is no need to continue. If the first test fails, the next two tests are completed to obtain results of each leg and the magnetic switch itself. The Magnetic switch is energized by the ignition switch in each test. For safety, disconnect the negative cable from the battery while making the connections.

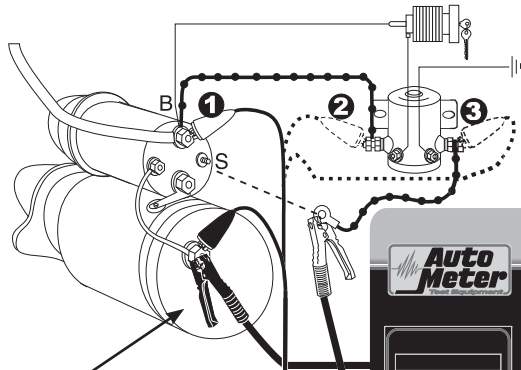

Magnetic Circuit 3-Step Setup

NOTE: ON 12 VOLT SYSTEMS THE SMALL BLACK LEAD CAN BE LEFT DISCONNECTED OR CAN BE CONNECTED TO ANY GROUND. ON 24 VOLT SYSTEMS THIS LEAD MUST BE CONNECTED TO THE STARTER GROUND.

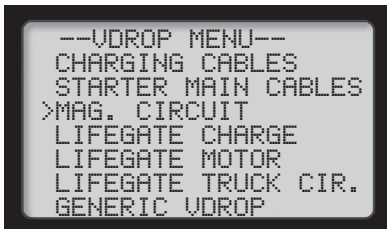
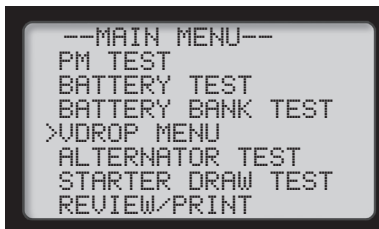
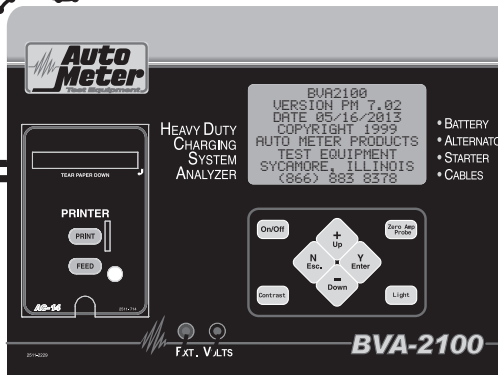

This is a continuation of the Starting System Test, but can also be selected from the VDrop Menu by selecting >MAG. CIRCUIT then press Enter. In the individual test you will be asked to disconnect the Magnetic circuit from the "S" terminal on the starter solenoid as explained on the previous page. This is necessary to avoid starting the engine during this test sequence.

10 INDIVIDUAL STARTER DRAW TEST

The starter draw test measures the amount of current needed to crank the engine and provides the initial information to diagnose and/or further test the starting system if necessary. What may appear to be a major problem may turn out to be a minor problem. Also, what appears to be a starter problem may be something more major.

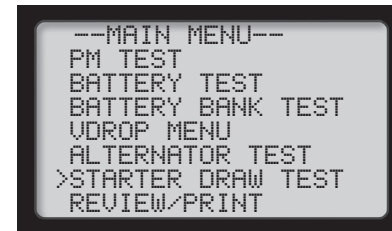

If the Amp Probe is attached you will be asked to zero it and attach it to the starter cable. See page 19 for more information.

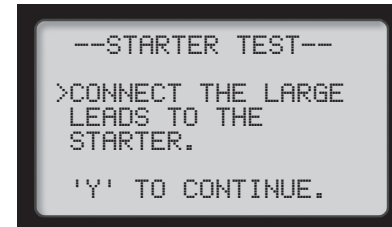

Connect large leads to the starter.

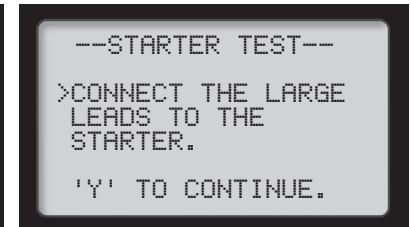

Then connect small leads to the battery.

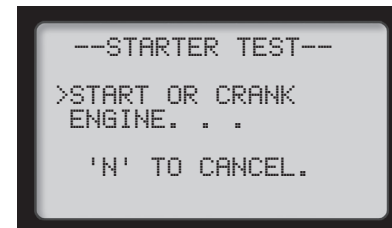
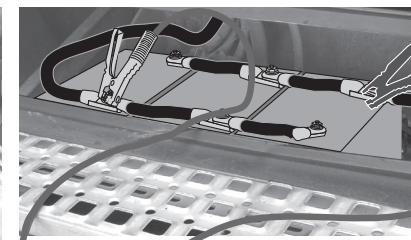
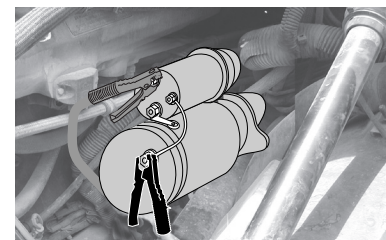

Waiting for loading then start or crank the engine when instructed.

After a few seconds the test result will appear.

STARTING VDROP (Cont.)

Note: The circuit from the battery to the starter junction and to each battery bank is being tested. If a dual battery bank is used the menu instructions will differ than with a single battery bank. In the following sequence it will be assumed that the choice is a dual battery bank.

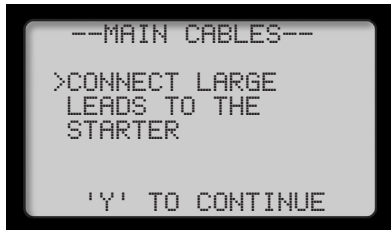

Connect large leads to the starter.

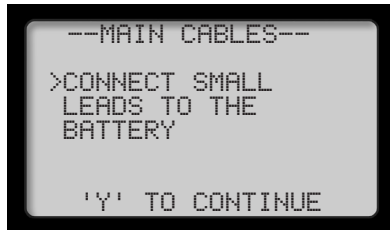

Then connect small leads to the battery bank – the red on the positive main and the black on the negative main and not to an individual battery. The added small external leads will check the main cables. Press (Y Enter).

Just as the System Test checks the Magnetic Circuit first it also checks the main starting cables.

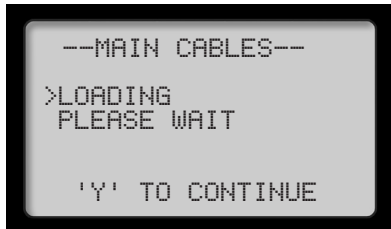

If all connections are correct, wait for a load test to be performed.

The results will vary depending upon and the conditions of the cables. Both the positive and negative circuit results will be indicated from the single test. If the test does not pass, correct the connection or replace the cable and run the test again.

VDROP ERROR MESSAGES See page 17

INDIVIDUAL MAGNETIC CIRCUIT TEST (Cont.)

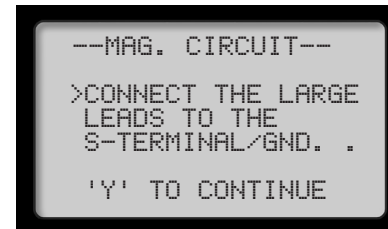

Connect the large red clamp (+) to the disconnected ring from the S-terminal magnetic circuit. Connect the large black clamp (-) to the starter ground (See Illustration)

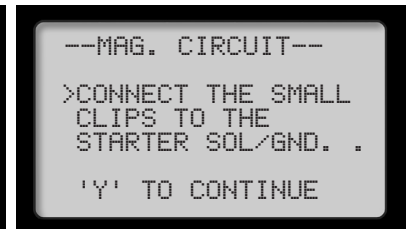

Connect the small red lead (+) to the "B" terminal (+) of the starter solenoid. Attach the small black lead (-) to the starter ground (See Illustration - small clamp position 1).

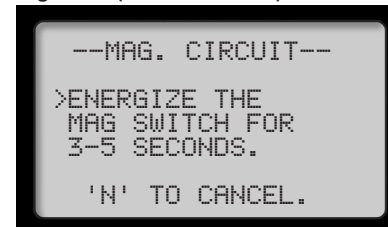

Reconnect the negative terminal on the battery. Then energize the Magnetic Switch for 3-5 seconds. Note. This can be done by a remote starter or by a second person turning the ignition.



Wait for results.

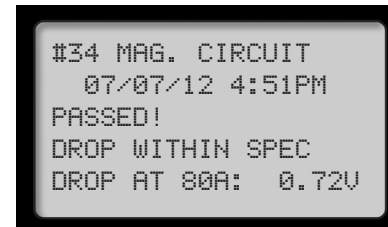

If voltage drop is within specifications the whole circuit passes.

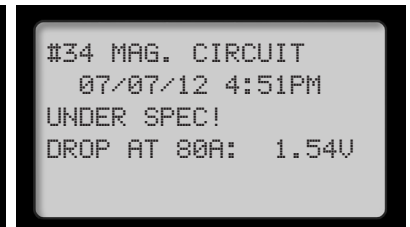

If the test FAILED! the BVA-2100 will advance to the next menu. Failure is indicated by more than 1 Volt drop at 80 Amps.

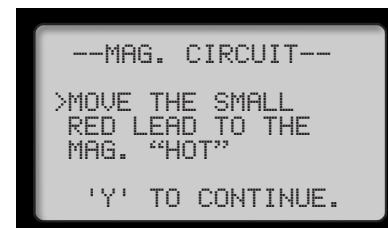

Move the small red lead to the magnetic switch hot side connection from the battery, press enter and energize the switch again for 3-5 seconds (See Illustration - small clamp position 2).

MAGNETIC CIRCUIT TEST (Cont.)



```
--MAG. CIRCUIT--
>MOVE THE SMALL
RED LEAD TO THE
MAG. "HOT"
'Y' TO CONTINUE.
```

Move the small red lead to the negative (-) side of the magnetic switch, press enter and energize again for 3-5 seconds (See Illustration - small clamp position 3).

```
#340 MAG/CABLES
LEG1: 2.22V FAIL
MAG.: 0.41V FAIL
LEG2: 0.12V PASS
```

The final results will appear indicating the section of the circuit or switch that is in need of repair.

9 STARTING SYSTEM VDROP TEST

Loose or corroded terminal connections and damaged or undersized wires can produce resistance, which causes a voltage drop between starting system components. Using the following procedure, Volt readings can be taken at each part of the circuit, pinpointing the location of the voltage drops. In the System test the charging cables are tested before the individual starter can be tested.

```
--MAIN MENU--
PM TEST
BATTERY TEST
BATTERY BANK TEST
>VDROP MENU
ALTERNATOR TEST
STARTER DRAW TEST
REVIEW/PRINT
```

This test can also be selected from the main menu by selecting Starter Test then press (Y Enter).

```
--VDROP MENU--
CHARGING CABLES
>STARTER MAIN CABLES
MAG. CIRCUIT
LIFEGATE CHARGE
LIFEGATE MOTOR
LIFEGATE TRUCK CIR.
GENERIC VDROP
```

Select >VOLTAGE DROP from the main and then select >STR MAIN CABLES and press (Y Enter).

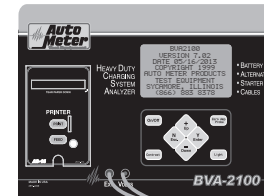

Dual Battery Setup
Each Starting Cable
Tested Separately

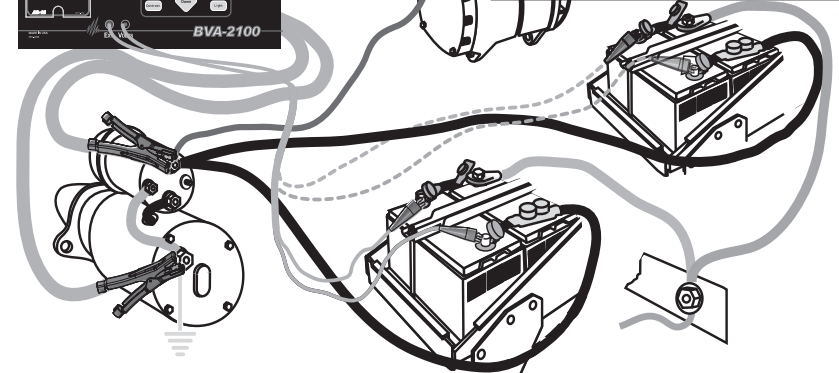

```
--MAIN CABLES--
>DOES VEHICLE HAVE
SPLIT BATTERY
SYSTEM?
'N' OR 'Y'
```

Does the vehicle have a split battery system? This entry is necessary for the tester to calculate 1/2 for each system if selected.