

Wiring Installation Instructions for : Pressure Gauge 2 1/16" Spek Pro Professional Racing Gauge

SPEK PRO™ PRESSURE GAUGE

PACKAGE CONTAINS:

- Pressure Gauge
- Pressure Sender
- Wiring Harness
- Mounting Cup
- (1) Neoprene EDPM Grommet

FEATURES:

SPEK PERFORMANCE GAUGE FEATURES:

- INTELLIGENT ELECTRICAL GAUGES.
- GAUGES ARE PROGRAMMED THROUGH COMMAND KEYS ON FACEPLATE.
- STEPPER MOTOR DRIVES THE GAUGE POINTER OVER A 280 DEGREE SWEEP.
- WIDE-ANGLE-DIAL™ HAS A 15% LARGER VIEWING AREA ON A 2 1/16" GAUGE.
- PROGRAMMABLE 7 COLOR DIAL AND **RED** POINTER ILLUMINATION.
- OPTIONAL OUTPUT CONTROL MODULE.

INSTALLATION INSTRUCTIONS:

1 DISCONNECT NEGATIVE (-) BATTERY TERMINAL.

2 VARIOUS MOUNTING SOLUTIONS ARE PRESENTED BY PROPARTS
DASH INSTALLATION: SELECT LOCATION IN THE DASH TO MOUNT GAUGE AND CUT A 2 1/16" HOLE. USE A FILE TO INCREASE THE HOLE SIZE IF REQUIRED. BE SURE THERE IS SUFFICIENT ROOM BEHIND THE HOLE FOR THE METER CASE AND THE CONNECTORS YOU WILL USE.

3 IF A SUITABLE HOLE IN THE FIRE WALL IS NOT AVAILABLE, CUT AN 11/16 HOLE.

4 Grommet MUST BE CUT TO PERMIT INSTALLATION OF WIRING HARNESS. (SEE **DIAGRAM 1**)

Wiring Installation Instructions for : Pressure 2 1/16" Spek Pro Professional Racing Gauge

- 5** INSTALL GROMMET AND MOUNTING CUP ON THE WIRING HARNESS AS SHOWN IN **DIAGRAM 1**. GROMMET IS FOR THE HOLE IN THE FIREWALL
- 6** DO NOT CONNECT WIRING HARNESS TO THE GAUGE UNTIL THE OTHER CONNECTIONS HAVE BEEN MADE AND TESTED.
- 7** SELECT A LOCATION FOR MOUNTING THE SENDER. SENSOR MUST BE IMMERSSED IN FLUID 3-6 MM FOR AN ACCURATE READING. WIRING SHOULD BE SECURED TO A FENDERWELL OR FIREWALL TO INSULATE THE SENDER FROM VIBRATION.
- 8** OIL, DIFFERENTIAL AND TRANSMISSION SENDERS MAY REQUIRE A MOUNTING HOLE BE DRILLED AND A 1/4" NPTF ADAPTER WELDED IN PAN.
- 9** USE TEFLON SEALING COMPOUND. TAPE IS NOT RECOMMENDED.
- 10** TEST ALL FITTINGS FOR LEAKS.
- 11** CONNECT THE **RED** (+12 VOLT SUPPLY) WIRE TO "ON" CIRCUIT THAT GETS POWER WHEN THE IGNITION IS TURNED ON. THIS CIRCUIT MUST BE FUSED BEFORE THE IGNITION SWITCH (5 AMP, FAST ACTING FUSE).
- 12** CONNECT THE **BLACK** WIRE TO A GOOD GROUNDING POINT ON THE CAR'S CHASSIS.
- 13** CONNECT THE **WHITE** WIRE TO THE DIMMER VOLTAGE GOING TO THE DASH LIGHTS.
- 14** TERMINATE GAUGE WIRES 2,3,4 TO GREEN/WHITE, BLACK AND RED/WHITE SENSOR LEADS AS SHOWN IN DIAGRAM 1
- 15** PLUG THE WIRING HARNESS INTO THE GAUGE AND MOUNT IN POD OR DASH. USE CARE WHEN CONNECTING OR DISCONNECTING THE WIRING HARNESS.
- 16** FOR DASH MOUNTING, ATTACH MOUNTING CUP OVER THE BACK OF THE GAUGE AND HAND TIGHTEN. DO NOT OVER-TIGHTEN. MOUNT CUP BEFORE INSTALLING GROMMET. FAILURE TO DO SO WILL TWIST WIRES CAUSING A SHORT CIRCUIT.
- 17** POWER UP THE GAUGE AND INSPECT ALL CONNECTIONS. IF GAUGE IS OPERATING NORMAL, PROCEED TO "PROGRAMMING MANUAL."

TROUBLESHOOTING:

- 1** THE GAUGE FACEPLATE WILL FLASH ALTERNATELY "**RED**" THEN "**GREEN**" IF THE SENSOR PROBE IS NOT CONNECTED TO THE WIRING HARNESS.
- 2** DO NOT USE ANY SENDER ADAPTER THAT WOULD REDUCE THE SENSORS IMMERSION IN FLUID. FOR ACCURACY, SENSOR SHOULD BE 3-6MM IMMERSSED IN THE FLUID IT IS MONITORING.

Wiring Installation Instructions for : Pressure 2 1/16" Spek Pro Professional Racing Gauge

DIAGRAM 1

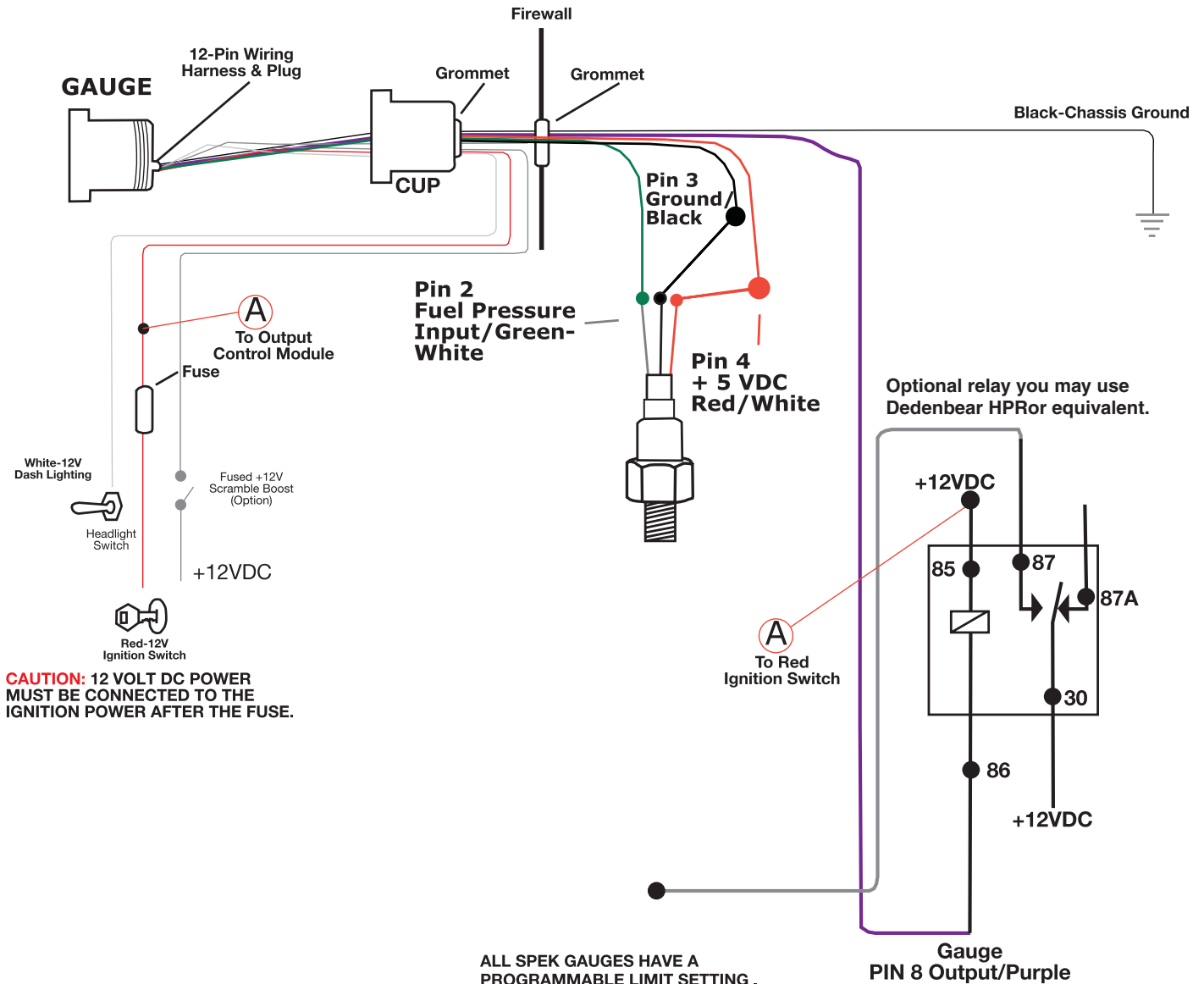

**PATENTED WIDE ANGLE DIAL
FOR SUPERIOR VISIBILITY
U.S PATENT #7,278,749**

ALL SPEK GAUGES HAVE A PROGRAMMABLE LIMIT SETTING . WHEN A SETTING IS TRIPPED, AN OUTPUT SIGNAL IS GENERATED. THIS CAN BE USED TO SWITCH ON A RUGGED 35 AMP RELAY TO ACTIVATE A LOW OIL ENGINE KILL, ALARMS, CUT THROTTLE BODY SENSOR TO DEFUEL KILL BOOST VALVE.

WARNING: OUTPUT CONTROL MODULE NOT TO EXCEED 1.5 AMPS AT 12 VOLTS DC. WARRANTY WILL BE VOID IF INCREASED OUTPUT VOLTAGE OR CURRENT IS APPLIED.

Wiring Installation Instructions for : Pressure 2 1/16" Spek Pro Professional Racing Gauge

DIAGRAM 2

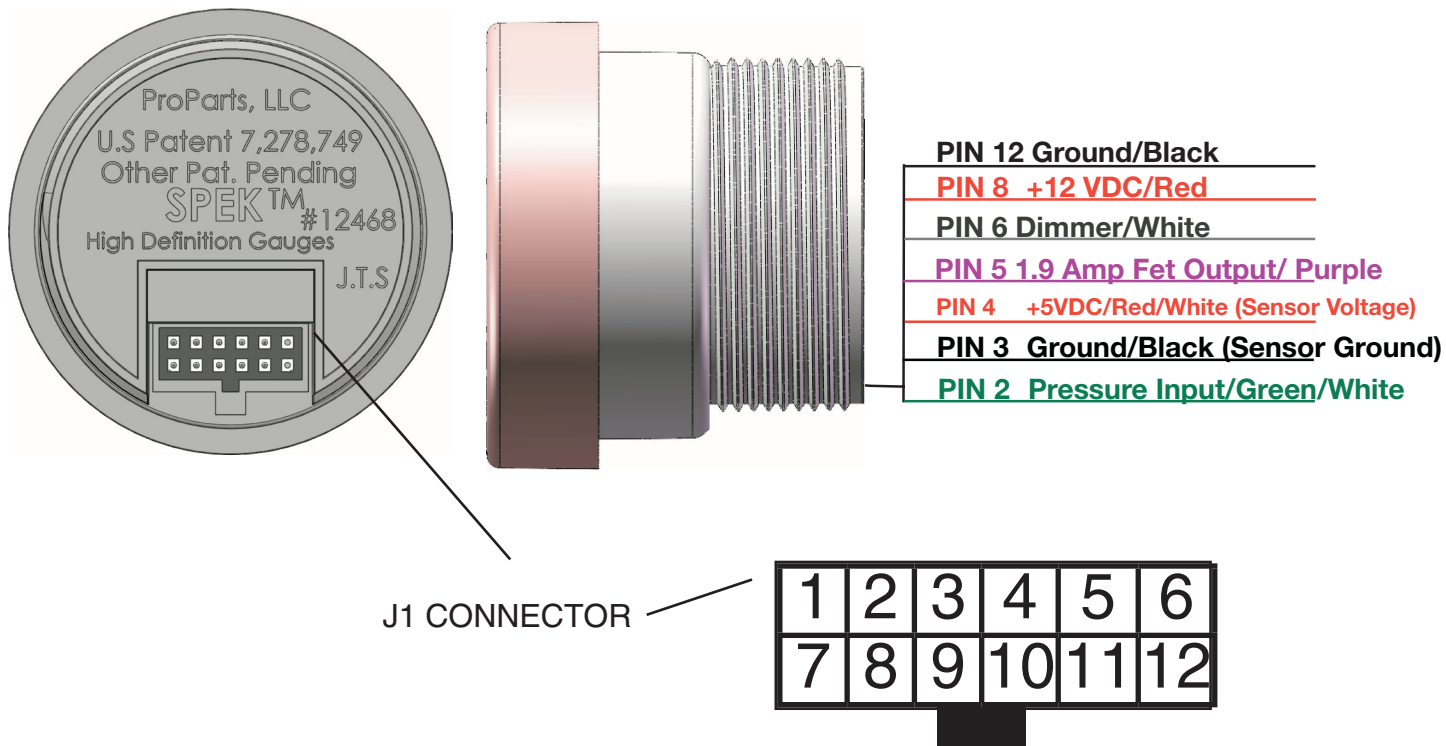

WARNING: 1. FUEL SYSTEM MAY BE UNDER PRESSURE AND MUST BE PROPERLY VENTED BEFORE INSTALLATION OF FUEL SENDER BY AN EXPERIENCED MECHANIC.

2. FUEL AND FUEL VAPOR ARE EXTREMELY FLAMMABLE. INSTALLER MUST TAKE EVERY PRECAUTION TO REMOVE ANY HOT MATERIAL. OPEN FLAME OR ANYTHING THAT IGNITE FUEL OR FUEL VAPOR.

Wiring Installation Instructions for : Pressure 2 1/16" Spek Pro Professional Racing Gauge

THERE ARE THREE SECTIONS TO THIS MANUAL: WIRING INSTRUCTIONS, PROGRAMMING INSTRUCTIONS AND FLOW CHART PROGRAMMING INSTRUCTIONS. PLEASE READ EACH SECTION CAREFULLY BEFORE ATTEMPTING TO INSTALL OR OPERATE THIS PRODUCT.

WARNING:

- **ALL INSTRUCTIONS IN THIS MANUAL MUST BE FOLLOWED TO INSURE SAFE INSTALLATION AND OPERATION OF THIS PRODUCT.**
 - **NEVER DISASSEMBLE MODIFY OR TAMPER WITH THIS PRODUCT. THIS COULD CAUSE DAMAGE AND MAKE THEM UNSAFE TO USE. TAMPERING WITH THE PRODUCT WILL VOID THE LIMITED WARRANTY.**
 - **INSTALLATION MUST BE PERFORMED BY AN EXPERIENCED AUTOMOTIVE TECHNICIAN.**
 - **INSTALLER MUST USE SAFETY GLASSES.**
 - **DISCONNECT THE NEGATIVE BATTERY TERMINAL BEFORE BEGINNING INSTALLATION. PROPARTS LLC IS NOT RESPONSIBLE FOR DAMAGE TO ENGINE, VEHICLE OR UNIT CAUSED BY ELECTRICAL SHORTS.**
 - **DURING INSTALLATION, DO NOT INTERFERE WITH ANY EXISTING CONNECTIONS OR WIRES.**
 - **ALL ELECTRICAL CONNECTIONS USE SOLDER LESS CONNECTORS AND INSULATE ALL CONNECTIONS WITH ELECTRICAL TAPE.**
 - **AVOID WIRING NEAR ENGINE, EXHAUST SYSTEM, TURBINE OR ANY AREA THAT MAY RESULT IN DAMAGE.**
 - **DISCONTINUE USE OF THE PRODUCT IF SMOKE OR A STRANGE ODOR IS PRESENT.**
- CAUTION**
- **PROPARTS LLC IS NOT RESPONSIBLE FOR INCORRECT INSTALLATION OR PROGRAMMING OF SPEK™ GAUGES OR CONTROLLERS.**
 - **SPEK™ GAUGES AND CONTROLLERS ARE DESIGNED FOR 12V DC ELECTRICAL SYSTEMS WITH A NEGATIVE GROUND.**
 - **DO NOT ADJUST THE GAUGES OR GAUGE PROGRAM WHILE DRIVING**
 - **OBEY ALL RULES AND REGULATIONS OF HIGHWAY AND STREET DRIVING.**
 - **INSTALL SENSOR AND WIRE AWAY FROM HIGH HEAT AND / OR VIBRATION AREAS.**
 - **USE CARE WHEN CONNECTING OR DISCONNECTING THE WIRING HARNESS. PULL OUT EACH CONNECTOR WHILE PRESSING THE LOCK OF THE CONNECTOR FIRMLY.**
 - **IF THE BATTERY TERMINAL IS DISCONNECTED, THE AUDIO, CLOCK AND OTHER MEMORY DATA MAY BE LOST. THE NECESSARY DATA WILL HAVE TO BE RESET AFTER INSTALLATION.**

Flow Chart Programming : Spek Pro Pressure 2 1/16" GAUGE - Nascar ECU Compatible



START HERE

PROGRAM MAIN MENU

(Press one button at a time)

MAIN MENU



NORMAL/DIAL BRIGHTNESS:
Press the down or up button to adjust dial brightness. Press the center button to save and advance to **PEAK PLAYBACK**.



NORMAL/DIAL BRIGHTNESS:
ON POWER UP THE GAUGE READS THE ECU. OPTION: CALIBRATE GAUGE TO ENVIRONMENT
OPTION: MONITOR ECU FUEL INJECTOR OR PRESSURE SENSOR.
Press the center button to advance to **PEAK PLAYBACK**.



PEAK PLAYBACK:
Reads the highest value displayed on the Gauge since the last time the PEAK value was displayed. PEAK value will be held in memory until erased by pressing the RIGHT or LEFT button while in the PEAK level Press the center button to advance to **HIGH RED-LINE SETTING**.



PEAK PLAYBACK:
Press the center button to advance to **HIGH RED-LINE SETTING**. OR
OPTION: RESTORE FACTORY DEFAULT



HIGH RED-LINE SETTING:
Press the down or up button to move dial pointer to the high threshold. Press the center button to save and advance to **LOW THRESHOLD SETTING**.



HIGH RED-LINE SETTING:
Press the center button to advance to **LOW THRESHOLD SETTING**.



LOW PRESSURE SETTING:
Sets the value at which the Low Pressure Warning is reached. The dial faceplate will flash RED for 60 seconds and then stay lit. Press the LEFT or RIGHT buttons to select the Low Pressure Setting. Press the center button to save and advance to **COLOR SCHEME**.



LOW THRESHOLD SETTING:
Press the center button to advance to **COLOR SCHEME**.



COLOR SCHEME:
Press down and up buttons to select a color scheme. (OFF-VIOLET-BLUE-GREEN-YELLOW-ORANGE-RED-WHITE). Press the center button to save and return to **NORMAL/DIAL BRIGHTNESS**.



COLOR SCHEME:
Press the center button to advance to **NORMAL/DIAL BRIGHTNESS**. OR
OPTION A: DEMO MODE

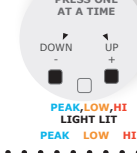

DIAL BRIGHTNESS:
Press the RIGHT or LEFT command buttons to Control the brightness of the faceplate illumination. Press the center button to save and advance to **NORMAL OPERATION**.



DIAL BRIGHTNESS:
Press the center button to advance to **NORMAL OPERATION**
OPTION A: POINTER BRIGHTNESS

Flow Chart Programming : Spek Pro Pressure Gauge - NASCAR ECU Compatible

SUBMENU

(ENTER FROM MAIN MENU)

(Press two(2) buttons simultaneously for 5 seconds)

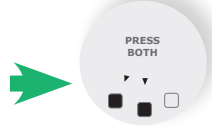

Calibrate Gauge to Environment: Turn the ignition ON with the engine OFF. While in the Normal Mode, press and hold the CENTER and LEFT buttons for five (5) seconds. The dial face plate will flash GREEN rapidly. Press the CENTER mode button to save the setting and return to NORMAL OPERATION.

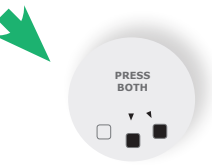

OPTION: MONITOR ECU FUEL INJECTION OR SENSOR

THE ECU IS THE FACTORY DEFAULT SETTING. TO CHANGE PROGRAM FIRST PUT +12 VOLTS ON THE WHITE / DIMMER CIRCUIT. WHILE IN THE NORMAL / DIAL BRIGHTNESS MODE. THEN PRESS AND HOLD BOTH THE CENTER AND RIGHT BUTTONS FOR 5 SECONDS. THE POINTER WILL STEP FIVE TIMES AND RETURN TO ZERO. THE FACEPLATE WILL LIGHT BLUE. TO SELECT THE PROGRAM, USE THE RIGHT (UP) OR LEFT (DOWN) BUTTON TO MOVE THE POINTER TO DESIRED OPTION.

- * MOVING POINTER TO ZERO (0) SETTING SELECTS MONITORING ECU FUEL INJECTION
- * MOVING THE POINTER TO HIGHEST PSI LOCATION (100 PSI) SETTING SELECTS MONITORING A PRESS-URE SENSOR.
- * PRESS THE CENTER (MODE) BUTTON TO SAVE THE PROGRAM.

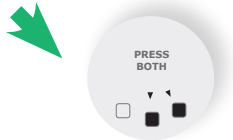

OPTION:RESTORE FACTORY DEFAULT:

While in **PEAK PLAYBACK**, press and hold the center and right buttons for five seconds. Dial pointer will step five times and return to zero. This will erase all user-programmed calibrations and settings, and return to **NORMAL/DIAL BRIGHTNESS**.



OPTION:DEMO MODE:

WHILE IN **COLOR SCHEME**, press and hold the center and right buttons for five seconds. Dial will scroll through the seven color schemes. The **HI,LOW** and **PEAK** will light, and the dial pointer will move. Press the center button to return to **NORMAL/DIAL BRIGHTNESS**.

Default Pressure Settings

Oil Pressure.....40 PSI high
 Water Pressure.....6 PSI low.....50 PSI high
 N2O Pressure

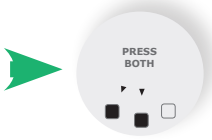

OPTION A:POINTER BRIGHTNESS:

Press CENTER and LEFT buttons for five (5) seconds to enter pointer brightness mode. The dial pointer will start to flash and point to the upper right.



OPTION:POINTER BRIGHTNESS:

Press LEFT or RIGHT buttons to adjust pointer brightness. Press the CENTER buttons to save and return to **NORMAL/DIAL BRIGHTNESS**.

Programming Instructions for : Pressure 2 1/16" Spek Pro Racing Gauge - ECU Fuel Injection Software

Refer to the "Flow Chart Programming Instructions" while reviewing this guide.

Gauge is field programmable by the operator while installed in the vehicle. This programming is accessed by pressing the control buttons located on the face or the meter dial, **ONE AT A TIME**. The "Down" and "Up" buttons move the pointer to a desired setting or controls the faceplate illumination.

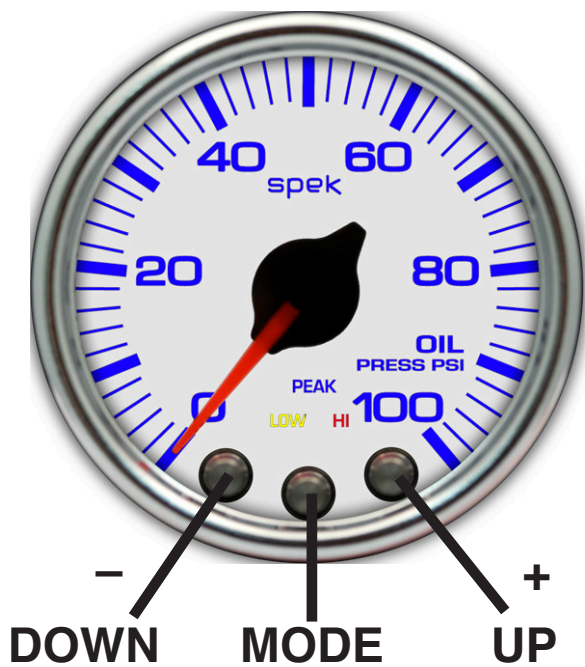

MAIN MENU PRESS "MODE" BUTTON TO PROGRAM LEVEL. THEN PRESS BOTH CENTER AND LEFT OR CENTER AND RIGHT BUTTONS FOR FIVE SECONDS TO ENTER SUBMENU	SUBMENU
NORMAL/DIAL BRIGHTNESS	OPTION:* CALIBRATE GAUGE TO ENVIRONMENT * MONITOR ECU FUEL INJECTION OR SENSOR
PEAK PLAYBACK	OPTION:RESTORE FACTORY DEFAULT
HIGH RED-LINE SETTING	
LOW THRESHOLD SETTING	
COLOR SCHEME	OPTION:DEMO MODE
DIAL BRIGHTNESS	OPTION:ADJUST POINTER BRIGHTNESS

Programming Instructions for : Pressure Spek Pro Racing Gauge - ECU Fuel Injection Software

PROGRAMMING STARTS IN MAIN MENU

PRESS PROGRAM BUTTON ONE (1) AT A TIME IN THE **MAIN MENU** MODE.

1 **NORMAL/DIAL BRIGHTNESS:**

On power up, the meter usually starts operation in **NORMAL/DIAL BRIGHTNESS**. Gauge reads the sensor value as temperature, pressure, etc. The "Down" and "Up" buttons will control the brightness of the dial lighting. Press the center "Mode" button to save the setting and advance you to **PEAK PLAYBACK**

2 **PEAK PLAYBACK:**

Reads the highest value displayed on the gauge since the last time the "PEAK" value was displayed. "PEAK" value will be held in memory until erased by pressing the RIGHT or LEFT button while in the "PEAK" level. Press the center "Mode" button to advance to **HIGH RED-LINE SETTING**

3 **HIGH RED-LINE SETTING:**

Sets the point at which "HIGH" warning threshold is reached for that specific gauge. The "Down" and "Up" buttons will move the dial pointer to select **HIGH RED-LINE SETTING**. During normal operation the gauge constantly monitors the sensor value and compares it to the "HIGH" threshold. If the threshold is exceeded, the red "HI" indicator is turned on. Press the center "Mode" button to save the setting and advance to **LOW THRESHOLD SETTING**

4 **LOW THRESHOLD SETTING:**

Set the Minimum Threshold: Sets the point at which "LOW" warning threshold is reached for that specific gauge. The "Down" and "Up" buttons will move the dial pointer to select the **LOW THRESHOLD SETTING**. During normal operation the gauge constantly monitors the sensor value and compares it to the "LOW" threshold. If the sensor value drops below the threshold, the yellow "LOW" indicator is turned on. Press the center "Mode" button save the setting and advance to

5 **COLOR SCHEME**

5 **COLOR SCHEME:**

Set Faceplate Color Scheme: Operator can select the color of the gauge dial illumination. Each time you press the "Down" control button you scroll through dial color selection until the dial light goes off. Then press the "Up" button to reverse the scroll. Select your dial color illumination by pressing the center "Mode" button to save the setting and advance to **DIAL BRIGHTNESS**

6 **DIAL BRIGHTNESS:**

Adjust dial brightness for day or evening driving conditions. The RIGHT or LEFT command buttons will dim or brighten faceplate illumination. Press the Center mode button to save the setting and return to **NORMAL OPERATION**.

Programming Instructions for : Pressure Spek Pro Racing Gauge - ECU Fuel Injection Software

SUBMENU

SUBMENU IS ACCESSED THROUGH THE **MAIN MENU**. FIRST GO TO THE APPROPRIATE LEVEL OF THE **MAIN MENU** AND THEN FOLLOW THE INSTRUCTIONS IN THE PROGRAMMING FLOW DIAGRAM TO ENTER THE **SUBMENU**. PRESS THE "MODE" AND "UP" OR "MODE" AND "DOWN" BUTTONS SIMULTANEOUSLY FOR 5 SECONDS TO ENTER THE **SUBMENU** AND ONE BUTTON AT A TIME WHILE IN THAT **SUBMENU**.

OPTION:CALIBRATE GAUGE TO ENVIRONMENT: Turn the ignition ON with the engine OFF. While in the Normal Mode, Press and hold the CENTER and LEFT buttons for five (5) seconds. The dial face plate will flash GREEN rapidly. Press the CENTER Mode button to save the setting and return to NORMAL OPERATION.

OPTION:RESTORE FACTORY DEFAULT: While in **Peak Playback**. Main Menu, press and hold both the CENTER and RIGHT buttons for 5 seconds. The dial pointer will step 5 times and return to zero (0). All user programmed setting will be erased and the gauge will return to **NORMAL OPERATION**

OPTION: MONITOR ECU FUEL INJECTION OR PRESSURE SENSOR:

THE ECU IS THE FACTORY DEFAULT SETTING. TO CHANGE PROGRAM FIRST PUT +12 VOLTS ON THE WHITE / DIMMER CIRCUIT. WHILE IN THE NORMAL / DIAL BRIGHTNESS MODE, PRESS AND HOLD BOTH THE CENTER AND RIGHT BUTTONS FOR 5 SECONDS. THE FACEPLATE WILL LIGHT BLUE. THE POINTER WILL STEP FIVE TIMES AND RETURN TO ZERO. TO SELECT THE PROGRAM, USE THE RIGHT (UP) OR LEFT (DOWN) BUTTON TO MOVE THE POINTER TO DESIRED OPTION.

- * MOVING POINTER TO ZERO (0) SETTING SELECTS MONITORING ECU FUEL INJECTION
- * MOVING THE POINTER TO HIGHEST PSI LOCATION (100 PSI) SETTING SELECTS MONITORING A PRESSURE SENSOR.
- * PRESS THE CENTER (MODE) BUTTON TO SAVE THE PROGRAM.

OPTION:DEMO MODE: Displays the features of the meter. The pointer goes up and down the scale, the dial colors change and the **HI**, **LOW** and **PEAK** warning indicators light. The **DEMO MODE** does not time out. If the gauge is turned off in the **DEMO MODE**, it will start up in the **DEMO MODE**. Press the "Mode" button to return the gauge to NORMAL operation.

OPTION:POINTER BRIGHTNESS MODE : The DOWN and UP buttons adjust the dial pointer brightness to blend in with original manufacturer's gauges and the owner's requirements. Press the MODE button to return to **NORMAL OPERATION**.

Programming Instructions for : Pressure Spek Pro Racing Gauge - ECU Fuel Injection Software

GAUGE CRITICAL CONDITION ALERT OUTPUT GUIDE

GAUGE TYPE	ALERT FLASHES "RED"
TEMPERATURE	HIGH
PRESSURE	LOW
TACHOMETER	HIGH
PYROMETER	HIGH
NITROUS OXIDE PRESSURE	LOW
BOOST PRESSURE	HIGH
AIR/FUEL	LOW
VOLTMETER	LOW

PROGRAMMING INFORMATION:

- TO RESET THE PROGRAM TO **NORMAL OPERATION** FROM ANY MODE PRESS THE "UP" AND "DOWN" BUTTONS SIMULTANEOUSLY. THIS SOFT RESET CANCELS THE INFORMATION YOU PROGRAMMED IN THAT MODE ONLY AND RETURN YOU TO **NORMAL OPERATION**.
- THE FACEPLATE WILL "FLASH" WHEN BUTTONS ARE DEPRESSED TO ACKNOWLEDGE COMMANDS.
- PROGRAMMING ERRORS WILL BE SIGNALLED BY FLASHING THE FACEPLATE LIGHTING "**PURPLE**", "**BLUE**", "**GREEN**" THEN "**ORANGE**".
- IF PROGRAMMING IS INACTIVE FOR 120 SECONDS THE MODE WILL TIME OUT AND THE GAUGE WILL RETURN TO NORMAL OPERATION, EXCEPT FOR IN THE DEMONSTRATION MODE. THE DEMO MODE WILL NOT TIME OUT UNTIL THE CENTER "MODE" BUTTON IS PRESSED. IF THE GAUGE IS TURNED OFF IN THE DEMO MODE, IT WILL START-UP IN THE DEMO MODE.
- TO RESTORE FACTORY DEFAULTS, PRESS THE "MODE" BUTTON ONCE TO ENTER THE **PEAK PLAYBACK**. THEN PRESS AND HOLD THE "MODE" AND "UP" BUTTONS FOR FIVE SECONDS. YOUR PROGRAMMING WILL BE ERASED BUT FACTORY PROGRAM WILL NOT BE AFFECTED.
- THE GAUGE FACEPLATE WILL FLASH ALTERNATELY "**RED**" THEN "**GREEN**" IF THE SENSOR PROBE IS NOT CONNECTED TO THE WIRING HARNESS.
- DO NOT USE ANY SENDER ADAPTER THAT WOULD REDUCE THE SENSORS IMMERSION IN FLUID. FOR ACCURACY, SENSOR SHOULD BE 3-6MM IMMERSSED IN THE FLUID IT IS MONITORING.