

Programming Quick Reference Guide

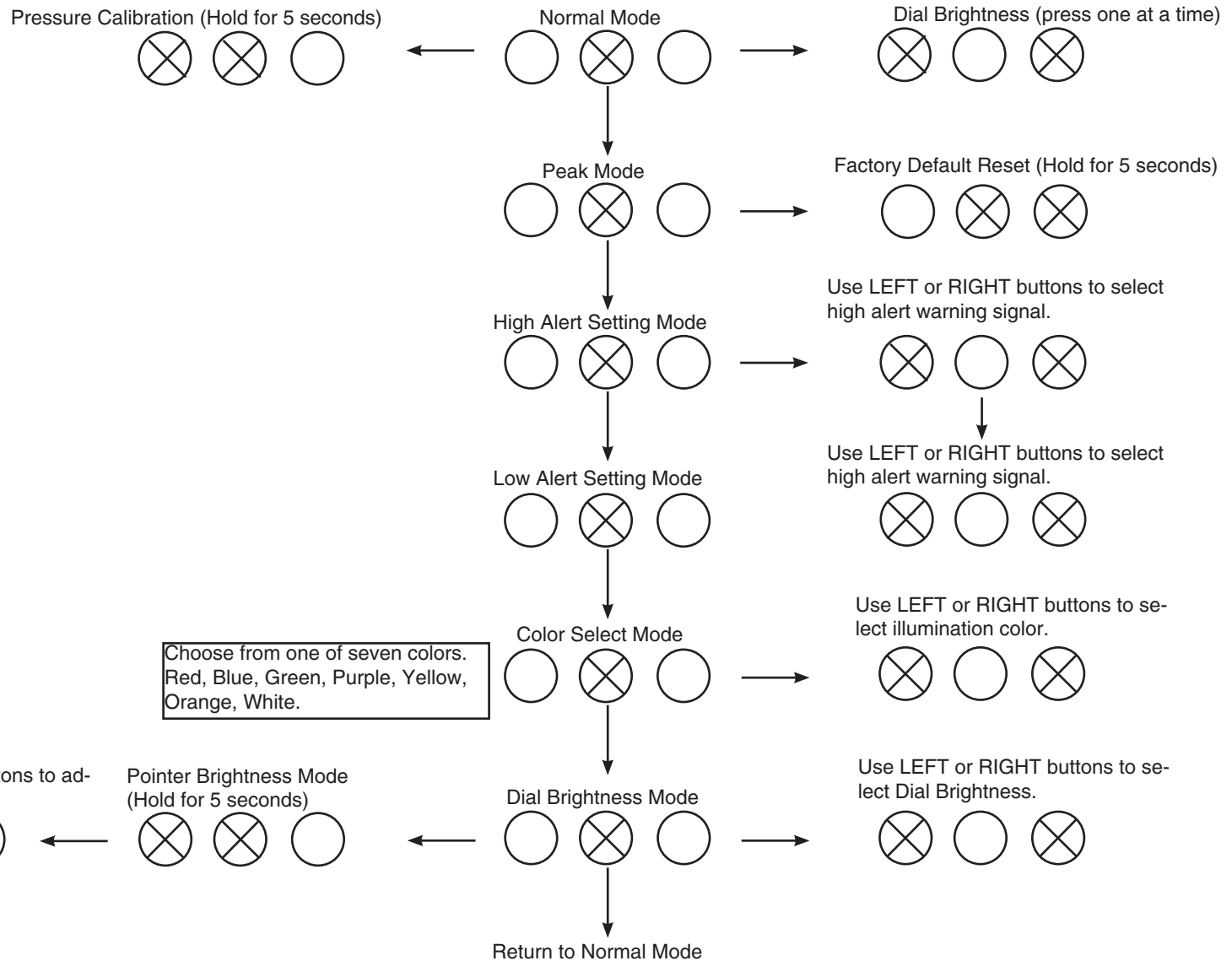

○ ⊗ ○ = Save changes and advance to next menu

⊗ = Depressed Button

⊗ ○ ⊗ = When pressed together exit menu without changes



Dual Input Fuel Pressure Programming Quick Reference Guide

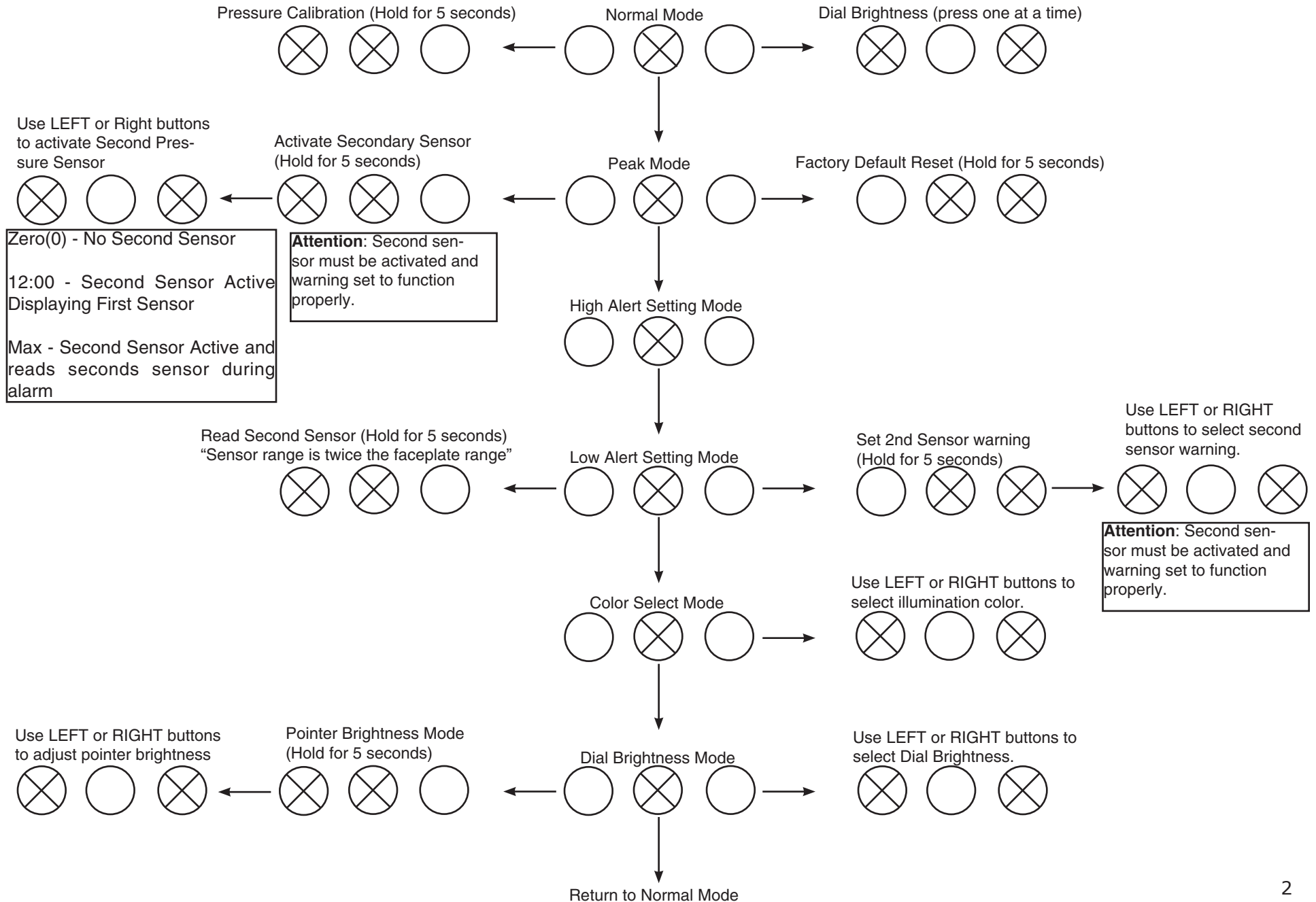
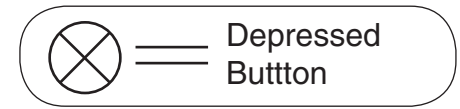



Temperature Programming Quick Reference Guide

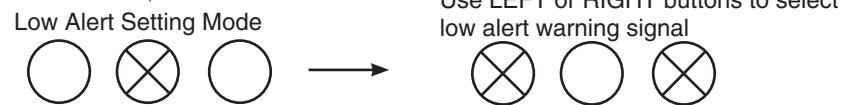
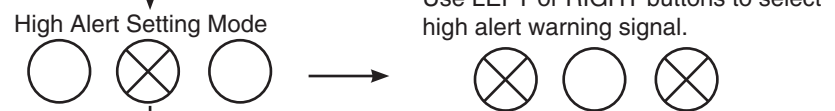
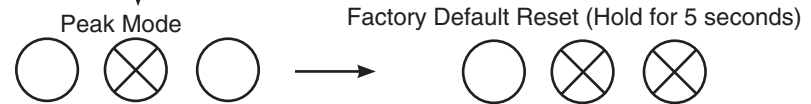
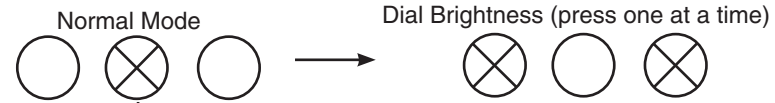

Choose from one of seven colors. Red, Blue, Green, Purple, Yellow, Orange, White.

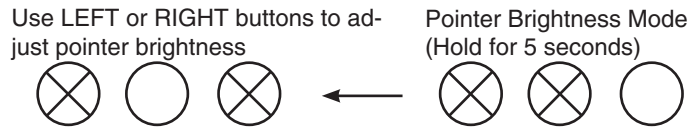

Return to Normal Mode

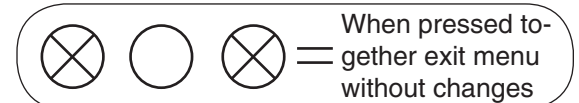
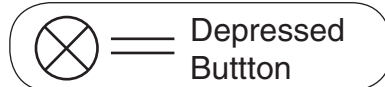
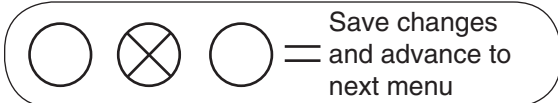



Tachometer Programming Quick Reference Guide

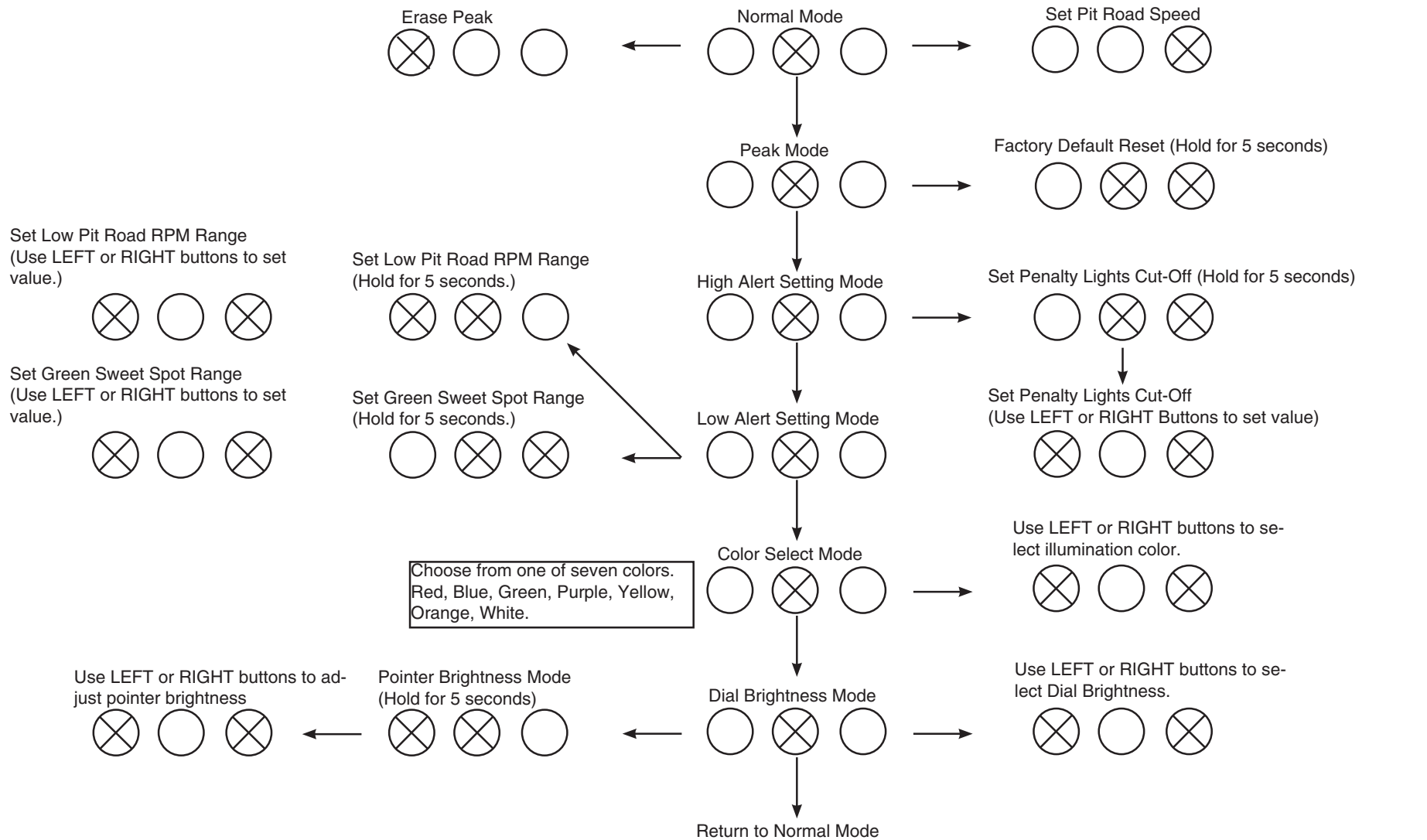

Choose from one of seven colors.
Red, Blue, Green, Purple, Yellow,
Orange, White.

