

Trademarks

Autel®, MaxiSys®, MaxiDAS®, MaxiScan®, MaxiTPMS®, MaxiRecorder®, and MaxiCheck® are trademarks of Autel Intelligent Technology Corp., Ltd., registered in China, the United States and other countries. All other marks are trademarks or registered trademarks of their respective holders.

Copyright Information

No part of this manual may be reproduced, stored in a retrieval system or transmitted, in any form or by any means, electronic, mechanical, photocopying, recording, or otherwise without the prior written permission of Autel.

Disclaimer of Warranties and Limitation of Liabilities

All information, specifications and illustrations in this manual are based on the latest information available at the time of printing.

Autel reserves the right to make changes at any time without notice. While information of this manual has been carefully checked for accuracy, no guarantee is given for the completeness and correctness of the contents, including but not limited to the product specifications, functions, and illustrations.

Autel will not be liable for any direct, special, incidental, indirect damages or any economic consequential damages (including the loss of profits).

IMPORTANT

Before operating or maintaining this unit, please read this manual carefully, paying extra attention to the safety warnings and precautions.

For Services and Support



pro.autel.com

www.autel.com

www.maxitpms.com



1-855-288-3587/1-855-AUTELUS (North America)

0086-755-22672493/86532091 (China)



supporttpms@auteltech.com

For technical assistance in all other markets, please contact your local distributor.

Safety Information

For your own safety and the safety of others, and to prevent damage to the device and vehicles upon which it is used, it is important that the safety instructions presented throughout this manual be read and understood by all persons operating or coming into contact with the device.

There are various procedures, techniques, tools, and parts for servicing vehicles, as well as in the skill of the person doing the work. Because of the vast number of test applications and variations in the products that can be tested with this equipment, we cannot possibly anticipate or provide advice or safety messages to cover every circumstance. It is the automotive technician's responsibility to be knowledgeable of the system being tested. It is crucial to use proper service methods and test procedures. It is essential to perform tests in an appropriate and acceptable manner that does not endanger your safety, the safety of others in the work area, the device being used, or the vehicle being tested.

Before using the device, always refer to and follow the safety messages and applicable test procedures provided by the manufacturer of the vehicle or equipment being tested. Use the device only as described in this manual. Read, understand, and follow all safety messages and instructions in this manual.

Safety Messages

Safety messages are provided to help prevent personal injury and equipment damage. All safety messages are introduced by a signal word indicating the hazard level.

DANGER

Indicates an imminently hazardous situation that, if not avoided, will result in death or serious injury to the operator or to bystanders.

WARNING

Indicates a potentially hazardous situation that, if not avoided, could result in death or serious injury to the operator or to bystanders.

Safety Instructions

The safety messages herein cover situations Autel is aware of. Autel cannot know, evaluate or advise you as to all of the possible hazards. You must be certain that any condition or service procedure encountered does not jeopardize your personal safety.

DANGER

When an engine is operating, keep the service area WELL VENTILATED or attach a building exhaust removal system to the engine exhaust system. Engines produce carbon monoxide, an odorless, poisonous gas that causes slower reaction time and can lead to serious personal injury or loss of life.

SAFETY WARNINGS

- Always perform automotive testing in a safe environment.
- Wear safety eye protection that meets ANSI standards.
- Keep clothing, hair, hands, tools, test equipment away from all moving or hot engine parts.
- Operate the vehicle in a well-ventilated work area, for exhaust gases are poisonous.
- Put the transmission in PARK (for automatic transmission) or NEUTRAL (for manual transmission) and make sure the parking brake is engaged.
- Put blocks in front of the drive wheels and never leave the vehicle unattended while testing.
- Be extra cautious when working around the ignition coil, distributor cap, ignition wires and spark plugs. These components create hazardous voltages when the engine is running.
- Keep a fire extinguisher suitable for gasoline, chemical, and electrical fires nearby.
- Do not connect or disconnect any test equipment while the ignition is on or the engine is running.
- Keep the test equipment dry, clean, free from oil, water or grease. Use a mild detergent on a clean cloth to clean the outside of the equipment as necessary.
- Do not drive the vehicle and operate the test equipment at the same time. Any distraction may cause an accident.

- Refer to the service manual for the vehicle being serviced and adhere to all diagnostic procedures and precautions. Failure to do so may result in personal injury or damage to the test equipment.
- To avoid damaging the test equipment or generating false data, make sure the vehicle battery is fully charged and the connection to the vehicle DLC is clean and secure.
- Do not place the test equipment on the distributor of the vehicle. Strong electro-magnetic interference can damage the equipment.

CONTENTS

	SAFETY INFORMATION	II
	SAFETY MESSAGES	II
	SAFETY INSTRUCTIONS.....	III
1	USING THIS MANUAL	1
	CONVENTIONS.....	1
2	GENERAL INTRODUCTION	3
	MAXI TPMS TS608 DISPLAY TABLET	4
	VCI – VEHICLE COMMUNICATION INTERFACE.....	7
	OTHER ACCESSORIES	10
3	GETTING STARTED	11
	POWERING UP	11
	POWERING DOWN.....	15
4	TPMS.....	16
	GETTING STARTED	16
	VEHICLE SELECTION	18
	TPMS CHECK.....	22
	TPMS DIAGNOSIS.....	24
	SENSOR PROGRAMMING	30
	TPMS RELEARN	36
	TPMS BY OEM PART NO.	40
5	DIAGNOSTICS	45
	GETTING STARTED	45
	VEHICLE IDENTIFICATION	46
	NAVIGATION	50
	DIAGNOSIS.....	52
	GENERIC OBD II OPERATIONS.....	64
	EXITING DIAGNOSTICS.....	68
6	SERVICE	70
	OIL RESET SERVICE	70
	ELECTRIC PARKING BRAKE (EPB) SERVICE	73

	BATTERY MANAGEMENT SYSTEM (BMS) SERVICE	76
	STEERING ANGLE SENSOR (SAS) SERVICE	82
	DIESEL PARTICLE FILTER (DPF) SERVICE	85
	IMMOBILIZER (IMMO) SERVICE	88
7	TOOLKIT	91
8	SETTINGS	93
	UNIT	93
	LANGUAGE	94
	PRINTING SETTING	95
	NOTIFICATION CENTER	96
	AUTO UPDATE	97
	SYSTEM SETTINGS	99
	ABOUT	100
9	UPDATE	101
	DISPLAY TABLET UPDATE	101
	MAXI/VCi MINI UPDATE	103
10	VCi MANAGER	105
	BT PAIRING	106
	UPDATE	106
11	SHOP MANAGER	107
	VEHICLE HISTORY	108
	WORKSHOP INFORMATION	110
	CUSTOMER MANAGER	111
12	ACADEMY	114
13	DATA MANAGER	115
	OPERATIONS	115
14	MAXIFIX	120
	NAVIGATION	120
	OPERATIONS	123
15	SUPPORT	129
	PRODUCT REGISTRATION	129

SUPPORT SCREEN LAYOUT.....	130
MY ACCOUNT.....	130
USER COMPLAINT.....	131
DATA LOGGING.....	133
COMMUNITIES.....	134
TRAINING CHANNELS.....	136
FAQ DATABASE.....	136
16 REMOTE DESK.....	137
OPERATIONS.....	137
17 QUICK LINK.....	139
18 FUNCTION VIEWER.....	140
19 MAINTENANCE AND SERVICE.....	142
MAINTENANCE INSTRUCTIONS.....	142
TROUBLESHOOTING CHECKLIST.....	143
ABOUT BATTERY USAGE.....	143
SERVICE PROCEDURES.....	144
20 COMPLIANCE INFORMATION.....	148
21 WARRANTY.....	151
LIMITED ONE YEAR WARRANTY.....	151

1 Using This Manual

This manual contains device usage instructions.

Some illustrations shown in this manual may contain modules and optional equipment that are not included in your system. Contact your sales representative for availability of other modules and optional tools or accessories.

Conventions

The following conventions are used.

Bold Text

Bold text is used to highlight selectable items such as buttons and menu options.

- Tap **OK**.

Notes and Important Messages

Notes

A **NOTE** provides helpful information such as additional explanations, tips, and comments.

NOTE

New batteries reach full capacity after approximately 3 to 5 charging and discharging cycles.

Important

IMPORTANT indicates a situation that, if not avoided, may result in damage to the test equipment or vehicle.

! **IMPORTANT**

Keep the cable away from heat, oil, sharp edges and moving parts. Replace damaged cables immediately.

Hyperlink

Hyperlinks or links that take you to other related articles, procedures, and illustrations are active in electronic documents. Blue italic text indicates a selectable hyperlink and blue underlined text indicates a website link or an email address link.

Illustrations

Illustrations used in this manual are samples, the actual testing screen may vary for each vehicle being tested. Observe the menu titles and on-screen instructions to make correct option selection.

2 General Introduction

When it comes to ultra-portability, MaxiTPMS TS608 (hereinafter referred to as TS608) is your perfect companion. Featuring a fast quad-core processor, TS608 offers maximum convenience and swift diagnosis. The intuitive user interface makes using the device effortless through a 7-inch LCD touch screen that displays at 1024 x 600 quality. Together with the ability to quickly read and clear Original Equipment Manufacturers (OEM) enhanced codes for TPMS module of the majority of the makes and models on the market, TS608 provides you with superior special functions for TPMS services with ease.

There are two main components of the TS608 system:

- TS608 Display Tablet – the central processor and monitor for the system.
- MaxiVCI Mini (Vehicle Communication Interface) – the device for accessing vehicle data.

This manual describes the construction and operation of both the devices and how they work together to deliver diagnostic solutions.

MaxiTPMS TS608 Display Tablet

Functional Description

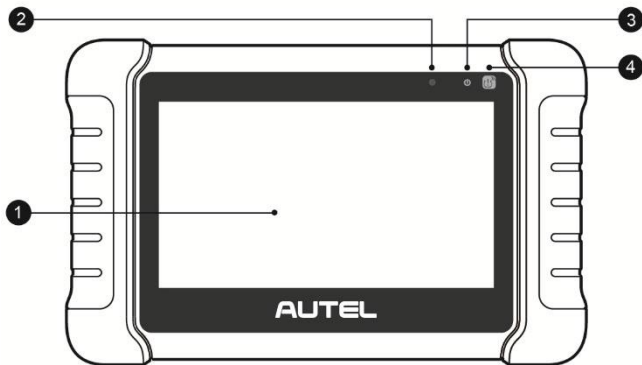

Figure 2-1 Display Tablet Front View

1. 7.0" LCD Capacitive Touchscreen
2. Ambient Light Sensor – detects ambient brightness.
3. Power LED – indicates battery level & charging or system status.
4. TPMS Service Symbol – indicates the position of the embedded TPMS antenna.

The power LED displays green, yellow or red depending on power level and operating state:

A. Green

- Illuminates green when the Display Tablet is charging and the battery level is above 90%.
- Illuminates green when the Display Tablet is powered on and the battery level is above 15%.

B. Yellow

- Illuminates yellow when the Display Tablet is charging and the battery level is below 90%.

C. Red

- Illuminates red when the Display Tablet is powered on and the battery level is below 15%.

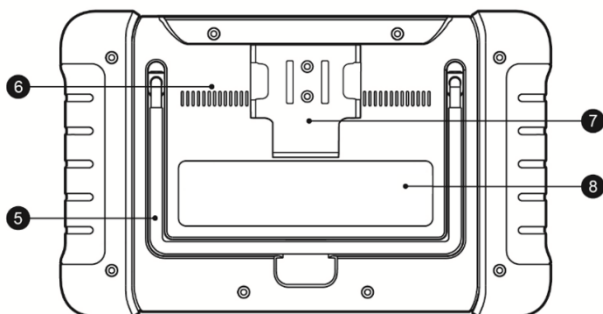

Figure 2-2 Display Tablet Back View

5. Collapsible Stand – extends from the back to allow hands-free viewing of the Display Tablet.
6. Heat Sink
7. MaxiVCI Mini Holder
8. Built-in Battery

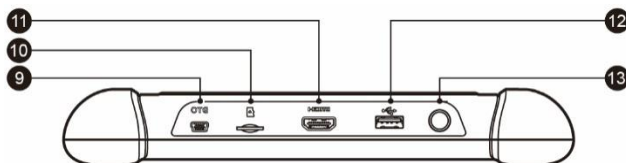

Figure 2-3 Display Tablet Top View

9. Mini USB OTG Port
10. Micro SD Card Slot – holds the micro SD card.
11. HDMI (High-Definition Multimedia Interface) Port
12. USB Port
13. Lock/Power Button – long press button to turn tablet off and on. Quick press button to lock screen.

Power Sources

The tablet can receive power from any of the following sources:

- Internal Battery Pack
- External Power Supply

Internal Battery Pack

The tablet can be powered with the internal rechargeable battery, which if fully charged can provide sufficient power for about 7 hours of continuous operation.

External Power Supply

The tablet can be powered from a wall socket using the USB external power adapter and the USB charging cable. The external power supply also charges the internal battery pack.

Technical Specifications

Table 2-1 Specifications

Item	Description
Recommended Use	Indoor
Operating System	Android™ 4.4.2, KitKat
Processor	Quad-core processor (1.6 GHz)
Memory	1GB RAM DDR3 & 64GB ROM
Display	7-inch LCD capacitive touchscreen with 1024x600 resolution
Connectivity	<ul style="list-style-type: none">● Mini USB 2.0● USB 2.0● Wi-Fi● HDMI Type A● Micro SD card slot (supports up to 32GB)
Sensors	Light sensor for brightness auto adjust

Item	Description
Audio input/output	Input: N/A Output: Beep
Power and Battery	<ul style="list-style-type: none"> ● 3.7 V/5000 mAh lithium-polymer battery ● Charges via 5 VDC power supply
Tested Battery Life	Around 7 hours of continuous use
Battery Charging Input	5 V/1.5 A
Power Consumption	600 mA (LCD on with default brightness, Wi-Fi on) @3.7 V
Operating Temp.	0 to 50°C(32 to 122°F)
Storage Temp.	-10 to 60°C (14 to 140°F)
Operating Humidity	5% - 95% non-condensing
Dimensions (w x h x d)	270.8 mm (10.0") x 176.0 mm (6.9") x 36.0 mm (1.4")
Net Weight	885 g (2.31 lb.)
Protocols	ISO9141-2, ISO14230-2,ISO15765, K/L-Line, Flashing Code, SAE-J1850 VPW, SAE-J1850PWM, ISO11898 (Highspeed, Middlespeed, Lowspeed and Singlewire CAN, fault-tolerant CAN), SAE J2610,GM UART,UART Echo Byte Protocol, Honda Diag-H Protocol, TP2.0, TP1.6

VCI – Vehicle Communication Interface

The wireless diagnostic interface MaxiVCI Mini is a small vehicle communication interface (VCI) used to connect to a vehicle's DLC and connect wirelessly with the tablet for vehicle data transmission.

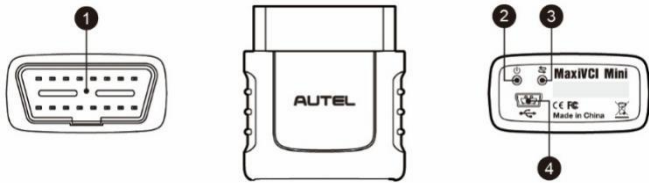

Figure 2-4 MaxiVCI Mini Views

Functional Description

1. Vehicle Data Connector (16-Pin) – connects the MaxiVCI Mini to the vehicle's 16-pin DLC directly.
2. Power LED – refer to [Table 2-2 Power LED on the Front Panel](#) on page 8 for details.
3. Connection LED – refer to [Table 2-3 Connection LED on the Front Panel](#) on page 8 for details.
4. USB Port – provides the easiest connection between the device and the display tablet via a USB cable.

Table 2-2 Power LED on the Front Panel

LED	Color	Description
Power	Green	Lights solid green when powered on.
	Red	Blinks red when system failure occurs. <i>Note: The power LED briefly lights red each time the device powers on and then lights green when the device is ready.</i>

Table 2-3 Connection LED on the Front Panel

LED	Color	Description
Connection	Green	<ul style="list-style-type: none"> ● Lights solid green when the device is successfully connected via USB cable but is not communicating with the vehicle. ● Blinks green when the device is successfully connected via USB cable and is communicating with the vehicle.

LED	Color	Description
Connection	Blue	<ul style="list-style-type: none"> ● Lights solid blue when the device is successfully connected via BT but is not communicating with the vehicle, ● Blinks blue when the device is successfully connected via BT and is communicating with the vehicle.

Technical Specifications

Table 2-4 Specifications





Item	Description
Communications	<ul style="list-style-type: none"> ● BT V.2.1 + EDR ● USB 2.0
Wireless Frequency	2.4 GHz
Input Voltage Range	9 VDC to 24 VDC
Supply Current	150 mA @ 12 VDC
Operating Temp.	0°C to 50°C (ambient)
Storage Temp.	-20°C to 70°C (ambient)
Dimensions (L x W x H)	47 mm (1.7") x 23 mm (0.9") x 51 mm (2.0")
Weight	33.1g (0.07 lb.)

Power Sources

The Vehicle Communication Interface MaxiVCI Mini operates on 12-volt vehicle power, which it receives through the vehicle data connection port. The unit powers on whenever it is connected to a vehicle data link connector (DLC).

Other Accessories

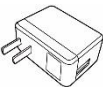
Table 2-5 Accessories

	MaxiVCI Mini Connects to the vehicle's DLC and provides wireless connection between the tablet and the vehicle.
	USB Cable (for test) 2 m
	USB Cable (for charging) 90 cm
	USB External Power Adapter Connects the tablet to the external DC power port for power supply.
	Hex Key Used to install and uninstall the sensor.
	Magnet (Needs to be purchased separately.) Used to trigger magnetically activated sensors (early model TPMS sensors).

3 Getting Started

Ensure the tablet is sufficiently charged or is connected to the external power supply (see [Power Sources](#) on page 6).

Powering Up

Press the Lock/Power button on the top right side of the tablet to power the unit on. The system boots, and displays the lock screen. Slide the Lock icon to the left to access the MaxiTPMS Job Menu or slide to the right to unlock.



Figure 3-1 Sample MaxiTPMS TS608 Job Menu

1. Application Buttons
2. Locator and Navigation Buttons
3. Status Icons

NOTE

The tablet screen is locked by default when first powered on. It is recommended to lock the screen to protect the information in the system and reduce the power consumption.









The touch screen navigation is menu driven enabling quick access to functions and features by tapping on options headings and answering







dialog windows. Detailed descriptions of the menu structures are found in application chapters.

Application Buttons

Descriptions of the tool applications are displayed in the table below.

Table 3-1 Applications











Button	Name	Description
	TPMS	Accesses the TPMS service program. See TPMS on page 16 for details.
	Diagnostics	Accesses diagnostic functions menu. See Diagnostics on page 45 for details.
	Service	Accesses special functions menu. See Service on page 70 for details.
	ToolKit	Accesses auxiliary functions menu for TPMS service. See ToolKit on page 91 for details.
	Settings	Accesses MaxiTPMS system settings menu and general tablet menu. See Settings on page 93 for details.
	Update	Accesses system software update menu. See Update on page 101 for details.
	VCI Manager	Accesses VCI connection menu. See VCI Manager on page 105 for details.
	Shop Manager	Accesses Shop Manager database to store workshop, customer information and vehicle test history. See Shop Manager on page 107 for details.

Button	Name	Description
	Academy	Accesses technical tutorials and training articles about the device or vehicle diagnostic techniques. See Academy on page 114 for details.
	Data Manager	Accesses the organization system for saved data files. See Data Manager on page 115 for details.
	MaxiFix	Launches the MaxiFix platform that provides the most compatible and abundant repair techniques and diagnostics database. See MaxiFix on page 120 for details.
	Support	Launches the Support platform that synchronizes Autel's on-line service base station with the MaxiTPMS tablet. See Support on page 129 for details.
	Remote Desk	Configures your unit to receive remote support using the TeamViewer application. See Remote Desk on page 137 for details.
	Quick Link	Displays associated website bookmarks for quick access to product update, service, support and other information. See Quick Link on page 139 for details.
	Function Viewer	Displays supported functions and vehicles coverage for Autel diagnostic tools. See Function Viewer on page 140 for details.

Locator and Navigation Buttons

Navigation icons display on the bottom of the tablet screen. The tablet below lists the icons functions.

Table 3-2 Locator and Navigation Buttons

Button	Name	Description
	Locator	Indicates on the location of the screen. Swipe the screen left or right to view the previous or next screen.
	Back	Returns to the previous screen.
	Android Home	Returns to Android System's Home screen.
	Recent Apps	Displays a list of applications that are currently in use. Tap an app icon to launch. To remove an app, swipe it to the top or bottom.
	Chrome	Launches the Chrome Internet browser.
	Screenshot	Takes a screenshot of the display.
	MaxiTPMS Home	Returns to MaxiTPMS Job Menu.
	VCI	Opens the VCI Manager application. The check at the bottom right corner indicates the tablet is communicating with the MaxiVCI Mini. An X will display if the tablet is not connected to VCI.
	TPMS Shortcut	Returns to the TPMS screen.
	Diagnostics Shortcut	Returns to the Diagnostics screen.
	Service	Returns to the Service screen.







System Status Icons

Tap on the bottom right corner to display Shortcuts Panel to set system settings of the tablet. Each icons function is described in the table below:

 **NOTE**

The shortcuts buttons will be highlighted when enabled, and dimmed when disabled.

Table 3-3 System Status Icons

Button	Name	Description
	Calculator	Launches calculator when pressed.
	Clock	Launches clock when pressed.
	BT	Enables/disables BT when pressed.
	Wi-Fi	Enables/disables Wi-Fi when pressed.
	Airplane Mode	Enables/disables Airplane Mode when pressed.
	System Settings	Launches the Android System Settings interface when pressed.

Powering Down

All vehicle communications must be terminated before powering off the tablet. A warning message will display if the unit attempts to power off while still connected with the vehicle. Forcing the tablet to power off while the unit is still communicating with the vehicle may lead to ECM problems on some vehicles. Exit diagnostics applications before powering off.

➤ **To power down the display tablet**

1. Long press the Lock/Power Button.
2. Tap **Power off** option.
3. Tap **OK**, the tablet will turn off in a few seconds.

Reboot System

In case of system crash, long press the Lock/Power button and tap **Reboot** option to reboot the system.

4 TPMS

TS608 provides the most comprehensive TPMS services for technicians to quickly solve TPMS related problems in the shortest time and with the highest efficiency.

Getting Started

TPMS Service Menu Layout

Tap **TPMS** on the MaxiTPMS Job Menu to access the TPMS Vehicle Menu.













Figure 4-1 Sample TPMS Vehicle Menu Screen

1. Top Toolbar Buttons – refer to [Table 4-1 Top Toolbar Buttons on Vehicle Menu](#) on page 17 for details.
2. TPMS Service Access Methods
 - OEM Part No.
 - Vehicle Manufacturer Buttons
3. Navigation Buttons
4. System Status Icons

Top toolbar Buttons

The operations of the Toolbar buttons at the top of the screen are described in the table below:

Table 4-1 Top Toolbar Buttons on Vehicle Menu

Button	Name	Description
	Home	Returns to the MaxiTPMS Job Menu.
	VIN Scan	Identifies vehicle make, model and year by retrieving Vehicle Identification Number (VIN) from the test vehicle. See Vehicle Identification on page 46 for details.
	All	Displays all the vehicle makes and the OEM Part No. function button.
	History	Displays the stored test vehicle history records. See Vehicle History on page 108 for details.
	USA	Displays the USA vehicle menu.
	Europe	Displays the European vehicle menu.
	Asia	Displays the Asian vehicle menu.
	China	Displays the Chinese vehicle menu.
	Search	Searches for a specific vehicle make.
	Cancel	Tap to exit the search screen, or cancels an operation.

TPMS Service Access Methods

OEM Part No.

Refer to [TPMS by OEM Part No.](#) on page 40 for details.

Vehicle Selection

Select the manufacturer and follow the onscreen instructions to select vehicle information to start a TPMS service session.

Navigation Buttons

Refer to [Table 3-2 Locator and Navigation Buttons](#) on page 14 for details.

System Status Icons

Refer to [Table 3-3 System Status Icons](#) on page 15 for details.

Vehicle Selection

The VIN Scan function is used to quickly identify the test vehicle, refer to [Auto VIN Scan](#) on page 46 for details.

Or, select a manufacturer brand on the TPMS Service Menu and follow the onscreen instructions to select the vehicle make, model and year.



Figure 4-2 Sample Vehicle Manufacturer Selection

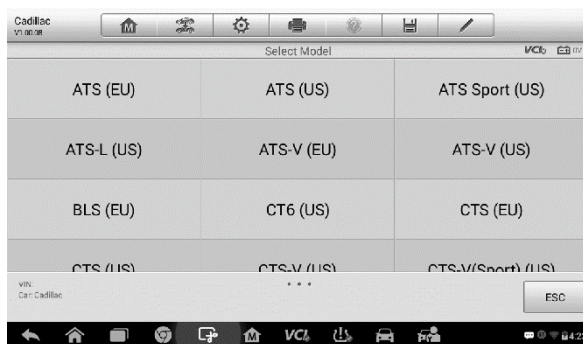

Figure 4-3 Sample Vehicle Model Selection

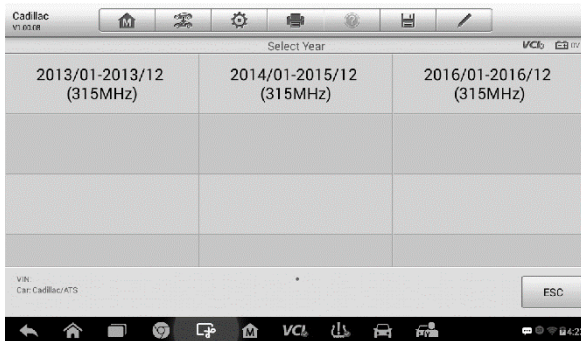

Figure 4-4 Sample Vehicle Year Selection 1

The following screen may display for vehicles using Indirect TPMS.

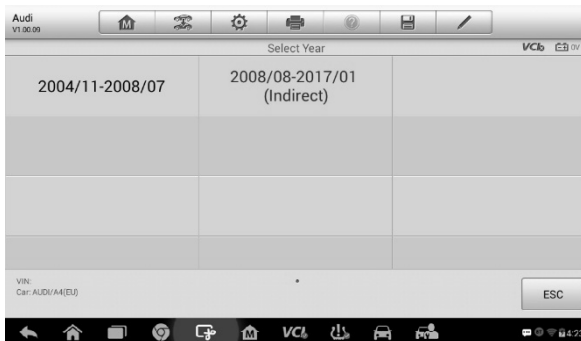

Figure 4-5 Sample Indirect TPMS Selection Screen

For **Indirect TPMS** vehicle, only the **Relearn** function is supported. Tap the vehicle year information button, in the case of the above screen – 2008/08-2017/01 (indirect), a vehicle year model confirmation message displays, click yes to confirm and display the Relearn Procedure, follow the instructions to complete the operation.

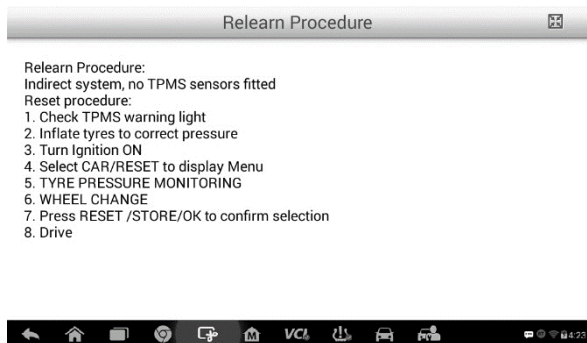

Figure 4-6 Sample Relearn Procedure for Indirect TPMS

For vehicles using **Direct TPMS**, select the correct vehicle. The TPMS service menu will display next.

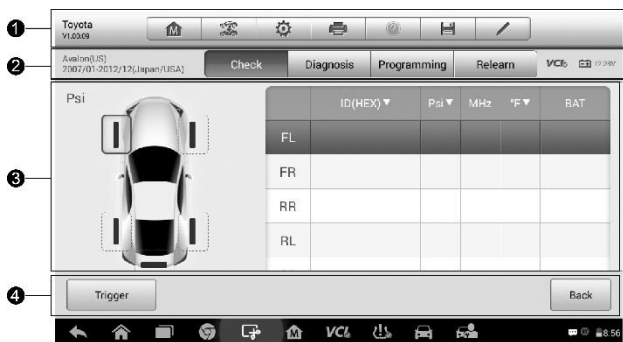









Figure 4-7 Sample TPMS Service Screen

1. Top Toolbar Buttons – refer to [Table 4-2 Top Toolbar Buttons on Service Menu](#) on page 21 for details.
2. Navigation Tab
3. Main Section
4. Functional Buttons

Table 4-2 Top Toolbar Buttons on Service Menu

Button	Name	Description
	Home	Returns to the MaxiTPMS Job Menu.
	Vehicle Swap	Exits the service session of the currently identified test vehicle and returns to the vehicle menu screen.
	Settings	See Settings on page 93.
	Print	See Printing Setting on page 95.
	Help	Displays operational instructions or tips.
	Save	Saves displayed information. See Data Manager on page 115.
	Data Logging	Records the communication data and ECU information of the test vehicle. See Data Logging on page 119 for details.

Navigation Tab

The navigation tab at the top of the Main Section screen contains the following items:

1. Check Tab – displays the triggered sensor data.
2. Diagnosis Tab – displays the sensor IDs and DTCs saved in the TPMS ECU.
3. Programming Tab – displays the triggered/retrieved sensor IDs and new programmed sensor IDs and sensor PSNs (Product Serial Number).
4. Relearn Tab – displays the sensor Relearn procedure and OE sensor information of the selected vehicle model.

The information of the test vehicle is displayed to the left of the four tabs. The VCI connection status and the battery level of the test vehicle are displayed to the right of the four tabs.

 **NOTE**

Not all vehicles support **Diagnosis** function. If the selected vehicle model does not support Diagnosis, this tab will not display.

Main Section

The data including sensor ID and battery status, tire pressure and temperature plus vehicle specific relearn procedures display depending on operation.

Functional Buttons

Specific Functional buttons will display depending on operation. These buttons or icons can be used to trigger the TPMS sensor, create sensor IDs, program MX-Sensors and return to the previous screen or exit.

TPMS Check

The **Check** function allows user to activate TPMS sensor to view sensor data - sensor ID, tire pressure, tire temperature, battery condition and sensor position.

➤ To check the sensors

1. Follow the steps in [Vehicle Selection](#) on page 18 to select the test vehicle.
2. Hold the top right corner of the tablet close to the sensor mounted on the wheel. The trigger antenna is embedded in the tool's upper right hand corner.
3. On the tablet, select the wheel you wish to trigger by either selecting the image of the wheel on the pictured vehicle or by selecting the corresponding wheel notation (FL, FR, RR, RL). Tap **Trigger** button to activate this sensor.
4. Once the sensor is successfully triggered, the information of the sensor will display.

If the battery level of a sensor is low, a red low battery icon  will display beside the wheel on the screen.

Once triggered, the wheel icons will display green or red indicating sensor status. Refer to [Table 4-3 Possible Results for Triggering](#) on page 23 for details.

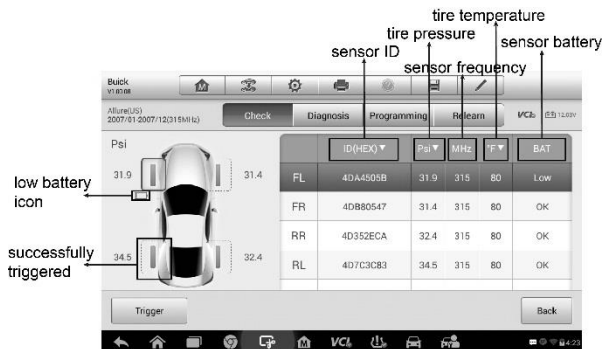





Figure 4-8 Sample Check Screen 2

The sensor position, sensor ID, tire pressure, tire temperature, sensor frequency and sensor battery information of the triggered sensor will display on the table.

Table 4-3 Possible Results for Triggering

Icon	Results	Description
 (Green)	Successful Sensor Read	TPMS sensor is successfully activated and decoded. The table displays the sensor information.
 (Green) 	Successful Sensor Read & Low Battery	TPMS sensor is successfully activated and decoded and the battery level of the sensor is low.

Icon	Results	Description
 (Red)	Failed Sensor Read	<p>If the search period expires and no sensor is activated or decoded, the sensor may be mounted incorrectly or does not function. The table displays "Failed".</p> <p>If the tire pressure is not in the normal range, the icon will turn red.</p> <p>If a sensor with a duplicate ID has been read, the screen displays a message "Sensor ID duplicated".</p> <p>Repeat the test procedure.</p>

TPMS Diagnosis

The **Diagnosis** function is used to check the status of the TPMS system. This function requires connection with the test vehicle.

Establish Vehicle Communication

The TS608 Diagnostic Platform connects to the test vehicle using the MaxiVCI Mini. Perform the following steps to establish communication between the vehicle and the tablet:

1. Connect the MaxiVCI Mini to the vehicle's DLC for both communication and power supply.
2. Connect the MaxiVCI Mini to the tablet via BT pairing. Refer to page 106 for instructions on Bluetooth (BT Pairing).
3. A green check will display atop the VCI navigation button at the bottom of the screen if communication has been established and the TS608 is ready to start vehicle diagnosis.

Vehicle Connection

The tablet communicates with the vehicle via the BT connection provided by the MaxiVCI Mini.

To connect the MaxiVCI Mini to the test vehicle, insert the Vehicle Data Connector on the MaxiVCI Mini into the vehicle's DLC which is generally located under the vehicle dash and the MaxiVCI Mini will be automatically powered on.

 **NOTE**

The vehicle's DLC is not always located under the dash; refer to the vehicle's user manual for DLC location.

VCI Connection

The MaxiVCI Mini Power LED will light solid green when properly connected to vehicle and ready to establish communication with the tablet.

The wireless diagnostic interface MaxiVCI Mini supports two communication methods with the tablet, wireless BT and wired USB.

BT Connection

BT pairing is the recommended communication between the tablet and the MaxiVCI Mini. The working range for BT communication is about 33 feet (about 10 m), enabling remote vehicle diagnostics.

If you use more than one MaxiVCI Mini to connect to the test vehicles, you can perform vehicle diagnosis on various vehicles conveniently by pairing the tablet separately to each of the MaxiVCI Mini devices connected to the different test vehicles via wireless BT. Without the need to repeat the plugging and unplugging procedure which is unavoidable through traditional wired connection, BT connection saves you more time and provides higher efficiency.

Refer to [BT Pairing](#) on page 106 for details.

USB Cable Connection

Use the provided USB cable to connect the tablet and the MaxiVCI Mini. A green check will display atop the VCI navigation button at the bottom of the screen and the MaxiVCI Connection LED will light solid green when connection between the devices is successful.

 **NOTE**

The USB communication method will take priority over BT communication if both are enabled.

No Communication Message

- A. An “Error” message will display if the MaxiVCI Mini is not connected correctly. To resolve this issue, please do the following.
- Check if the MaxiVCI Mini is powered on.
 - Check if the MaxiVCI Mini is properly positioned.
 - Check if the Connection LED on the MaxiVCI Mini is illuminated for BT or USB.
 - In case of BT connection, check if the network is configured correctly, or if the right MaxiVCI Mini has been paired up with the tablet.
 - ◇ If communication is lost during diagnosis, ensure there is no nearby object that might cause signal interruption.
 - ◇ Stand closer to the MaxiVCI Mini to obtain a stronger signal, and a faster communication speed.
 - When using USB connection, check the cable connection between the tablet and the MaxiVCI Mini.
 - Check the Power LED on the MaxiVCI Mini. A blinking red light indicates there is a hardware problem with the MaxiVCI Mini. Contact technical support for assistance.
- B. A message will display if the MaxiVCI Mini is unable to establish a communication link. The followings are the possible causes:
- The MaxiVCI Mini is unable to establish a communication link with the vehicle.
 - The system selected for testing is not equipped on the vehicle.
 - There is a loose connection.
 - There is a blown vehicle fuse.
 - There is a wiring fault of the vehicle or the adapter.
 - There is a circuit fault in the adapter.
 - Incorrect vehicle identification was entered.

Diagnosis Operations

Tap **Diagnosis**, the tablet will automatically communicate with the vehicle.



Figure 4-9 Sample Diagnosis Communication Screen



Figure 4-10 Sample Diagnosis Screen 1

If the OBD function is supported by the test vehicle, the sensor ID saved in the TPMS ECU will be retrieved and displayed on the screen with an OBD icon adjacent to it.

If the sensor ID retrieved from sensor activation is the same as the ID saved in the ECU, the trigger mark (📶) and OBD mark (🟢) will display green.

If the IDs are different, the marks will display red (📶 and 🟡). In this case, the vehicle ECU cannot recognize the sensor installed on the vehicle.

If the OBD function is not supported by the test vehicle, the sensor ID saved in the TPMS ECU cannot be retrieved and only the sensor ID retrieved from sensor activation will display on the screen with a signal icon.



Figure 4-11 Sample Diagnosis Screen 1

Details

If Diagnostic Trouble Codes (DTCs) are present in the TPMS ECU, a yellow hazard icon displays in the DTC column and the **details** button is available.

Tap **details** in the DTC column to view the detailed information of the DTCs.

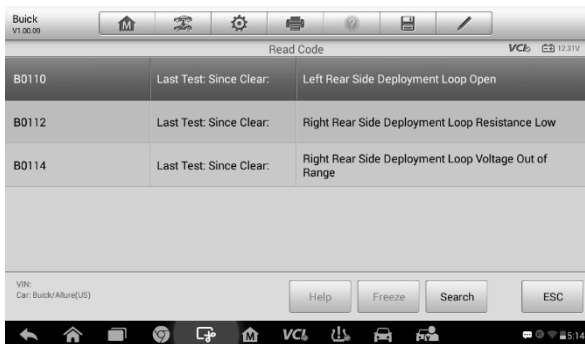

Figure 4-12 Sample DTCs Screen

In this screen, the detailed fault definition will display. Select one of the DTC and tap **Search**, the tablet will automatically connect to the Internet and additional information will display.

If no DTCs are present in the TPMS ECU, a green “No DTC” message will display on the DTC screen.



Figure 4-13 Sample No DTC Screen

Retry Diagnosis

Tap **Retry Diagnosis**, to establish communication with ECU again and retrieve sensor IDs and the DTCs present in the ECU.

Live Data

Tap **Live Data** to view the data stream of the sensor information.

Name	Value	Unit
<input type="checkbox"/> Ignition Status	On	
<input type="checkbox"/> Battery Positive Voltage	0.5	V
<input type="checkbox"/> Sensor 1 Learn Progress	No	
<input type="checkbox"/> Sensor 1 Learned	No	
<input type="checkbox"/> Sensor 1 Location	Unlocated	
<input type="checkbox"/> Sensor 1 ID	01900000	

Figure 4-14 Sample Live Data Screen

The Live Data screen displays all parameters by default.

Check the box before the parameters to display, the **Show** icon on the bottom of the screen will be available and display blue. Tap **Show** and the selected parameters will display on a separate screen.

For more details, please refer to [Live Data](#) on page 58.

Special Functions

Tap this button to display a menu of available special functions.

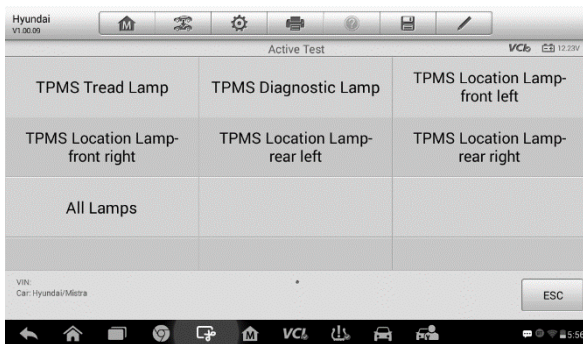

Figure 4-15 Sample Special Functions Screen

Tap button to initiate desired vehicle lamp function test.

Sensor Programming

The **Programming** function allows users to program the sensor data to the MX-Sensor to replace existing sensors with low battery life and ones that are no longer functioning.

This device offers four programming methods when programming MX-Sensor: **Copy by Activation**, **Copy by OBD**, **Copy by Input** and **Auto Create 1-16 Sensors**.

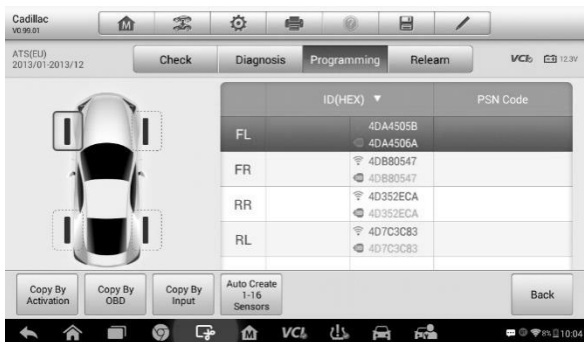

Figure 4-16 Sample Programming Screen 1

The sensor IDs retrieved from sensor activation and TPMS ECU will display on the left column of the table with the appropriate signal or OBD icon.

If the OBD function is not supported by the test vehicle and the sensor ID saved in the ECU cannot be retrieved, the Programming screen displays as pictured below.

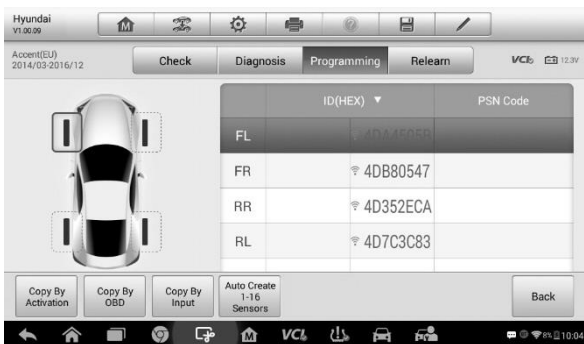

Figure 4-17 Sample Programming Screen 2

In this example, the OBD function is not supported by the test vehicle and therefore the **Copy by OBD** function will not display.

Copy by Activation

Once the sensors mounted on the vehicle have been triggered and the sensor and tire information displayed on the tool, the **Copy by Activation** can be used to program a new MX-Sensor.

Select a wheel location on the display and place a MX-Sensor near the top right corner of the tablet. Tap **Copy by Activation** to program a new MX-Sensor.



Figure 4-18 Sample Copy by Activation Confirmation Screen

A window will display for your confirmation. Tap **OK** to program, or tap **Cancel** to quit the operation.



Figure 4-19 Sample Copy by Activation Screen

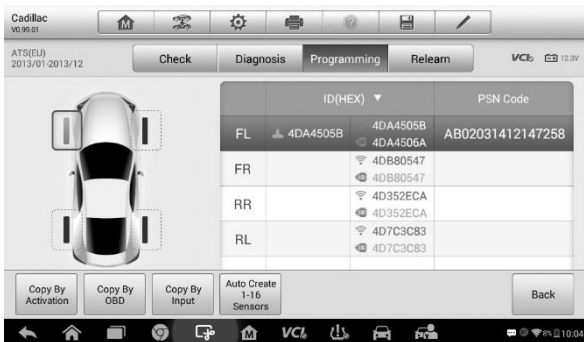

Figure 4-20 Sample Copy by Activation Complete Screen

When the programming is complete, the programmed ID will display in the column to the right of the wheel designation. In the pictured example, the new ID is displayed to the right of the FL column.

By using **Copy by Activation**, the sensor ID that is retrieved from activated sensor is programmed to the new MX-Sensor.

Because the IDs of the original sensor and the new MX-Sensor are the same and the ID is already recognized to the vehicle ECU, there is no need to perform the **Relearn** function when the new programmed sensor has been attached to the same wheel.

If the IDs retrieved from sensor activation and those registered to the TPMS ECU are different, use **Copy by OBD** to program the IDs saved in the ECU to the new MX-Sensor.

Copy by OBD

By using this function, the tablet will program the sensor IDs retrieved from the ECU of the test vehicle to the new MX-Sensors.

Select a wheel location on the display and place a MX-Sensor near the top right corner of the tablet. Tap **Copy by OBD** to program the new MX-Sensor.

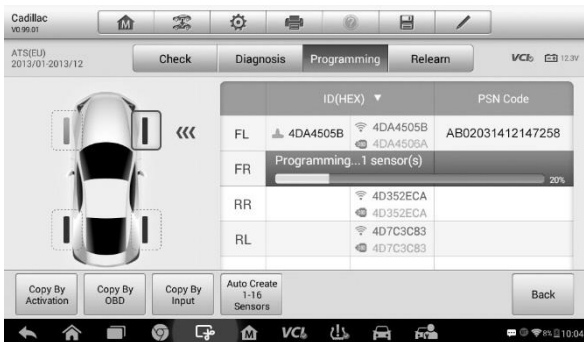

Figure 4-21 Sample Copy by OBD Screen

When the programming is complete, the programmed ID will display in the column to the right of the wheel designation. In the pictured example, the new ID is displayed to the right of the FR column.

By using **Copy by OBD**, the sensor ID that is retrieved from TPMS ECU is programmed to the new MX-Sensor.

There is no need to perform the **Relearn** function to write the ID into the ECU when the new programmed sensor has been put in the same position.

The **Copy by OBD** programming method, if available, is recommended to program new MX-Sensors as there is no need for Relearn.

Copy by Input

The **Copy by Input** allows users to program a new MX-Sensor with the ID of an original TPMS sensor.

Select a wheel location on the display and place a MX-Sensor near the top right corner of the tablet and then tap **Copy by Input** to program the new MX-Sensor.

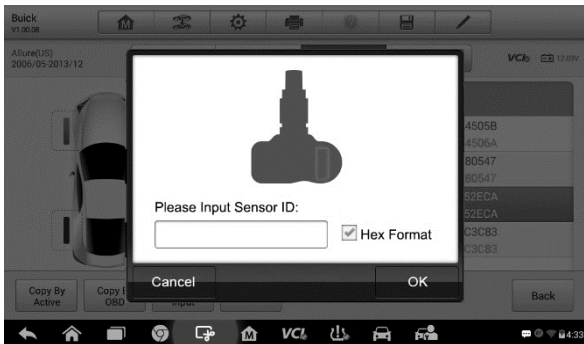

Figure 4-22 Sample Copy by Input Screen

Tap **Copy by Input**. When the input box displays, enter the ID of the original sensor. Tap inside the input box to display a soft keyboard. Once displayed, input the ID and tap **Enter** when finished.

Sensors either have a hexadecimal format or a decimal format. A warning message will display if too many characters are entered.

The **Copy by Input** programming method uses the ID of the original sensor that is already stored within the TPMS ECU and therefore does not require the sensor be relearned if the new programmed sensor has been put in the same position.

Auto Create 1-16 Sensors

The **Auto Create 1-16 Sensors** function is used to automatically create random sensor IDs to program new MX-Sensors. Up to 16 MX-Sensors can be programmed at the same time.

To use this function, there is no need to activate the original sensor or retrieve the original sensor IDs from the TPMS ECU.

Select the vehicle model, select a wheel location on the display and place a MX-Sensor near the top right corner of the tablet. Tap **Auto Create 1-16 Sensors** to program the new MX-Sensor.

A random ID will be created for the MX-Sensor. This new ID differs from the ID stored in the TPMS ECU, therefore the sensor will have to be relearned to the TPMS ECU.

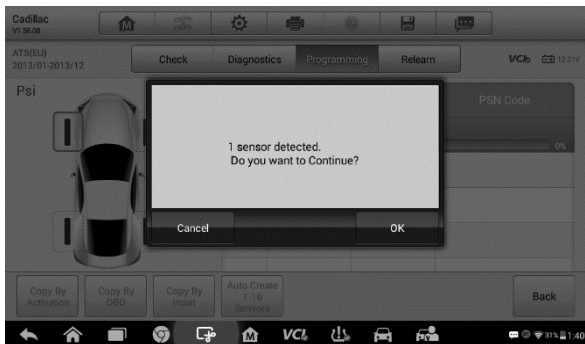

Figure 4-23 Sample Auto Create 1-16 Sensors Screen

TPMS Relearn

This function is used to write sensor IDs into the vehicle ECU for sensor recognition.

Relearn is needed to be performed when the new sensor IDs are different from the original sensor IDs stored within TPMS ECU.

There are THREE ways for Relearn.

- Stationary Relearn
- Automatic Relearn
- OBD Relearn

Stationary Relearn

Stationary Relearn requires the vehicle be placed in the “Learn Mode”.

Tap **Relearn** to access the relearn menu.

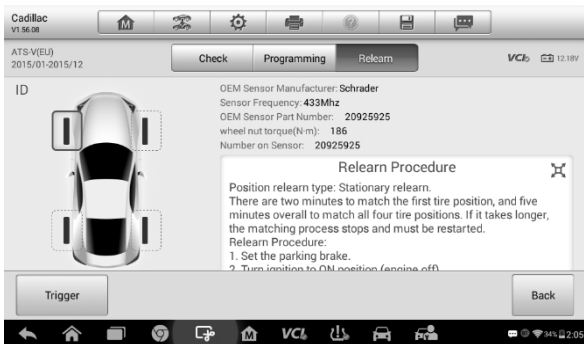

Figure 4-24 Sample Stationary Relearn Screen 1

Then follow the **Relearn Procedure** to perform Stationary Relearn.

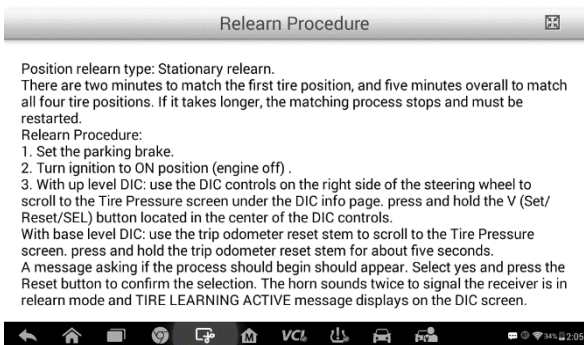

Figure 4-25 Sample Stationary Relearn Screen 2

Automatic Relearn

For some vehicles, the Relearn function can be completed by driving. Refer to the on-screen Relearn Procedure for the exact details of the process.

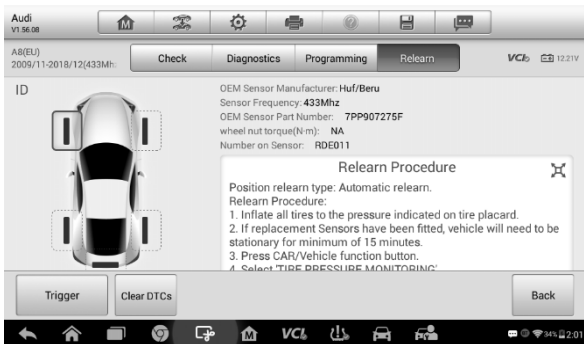

Figure 4-26 Sample Automatic Relearn Screen 1

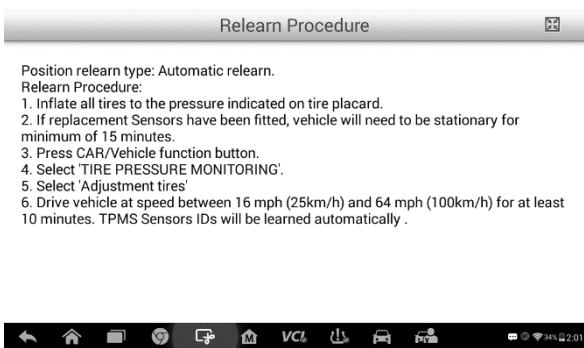

Figure 4-27 Sample Automatic Relearn Screen 2

OBD II Relearn

OBD II Relearn

The OBD II Relearn function allows the TS608 tablet to directly write the TPMS sensor IDs to the TPMS module.

NOTE

Not all the vehicles support the OBD II Relearn. If the selected vehicle supports OBD II Relearn, the OBD II Relearn button will display on the bottom of the screen.

To perform the Relearn, activate all four sensors.

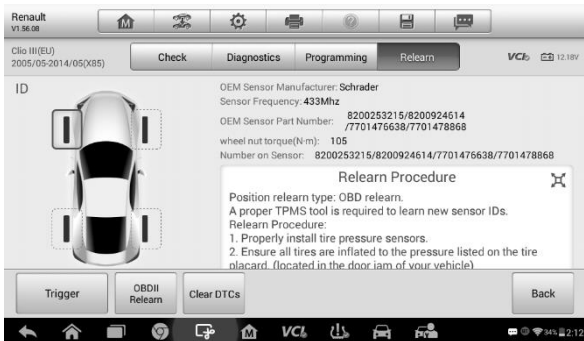

Figure 4-28 Sample OBD II Relearn Screen 1

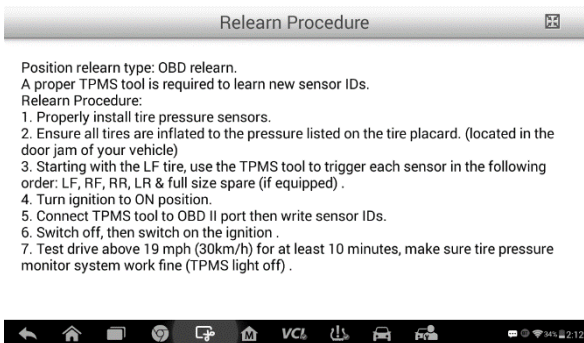

Figure 4-29 Sample OBD II Relearn Screen 2

OBd II-Assisted Relearn

The TS608 also can perform an OBd II-Assisted Relearn. Some vehicles relearn procedure require that a tool be connected to the vehicle while another tool be used to trigger the sensor at the wheel.

Since the TS608 tablet wirelessly communicates with vehicles, it can be used to trigger wheel-mounted sensors while still being connected with the vehicle eliminating the need for a second tool. The sensor IDs are then relearned to the vehicle.

After performing the Relearn procedure, tap **Clear DTCs** to clear the trouble codes present in the TPMS ECU.

TPMS by OEM Part No.

If the sensor's OEM part number is known, this function is an efficient method to activate and program MX-Sensors.

Application Scenarios

The following are two typical scenarios in which this method is ideal.

In the workshop

If the mounted sensor is faulty and the part number is known to the technician, the technician can use this method to Check the original sensor, and then write the information that was retrieved into a new MX-Sensor via **Programming**. The newly programmed MX-Sensor is ready to replace the original sensor and be installed on the vehicle.

In the tire shop

If a customer needs to replace one or more tires and sensors , or purchase a large amount of sensors for one vehicle model and the OEM part number of this model is known, this function can be used to program up to 20 sensors at the same time.

Function Operations

1. Tap **OEM Part No.** on the TPMS service menu to access the next screen. A list of sensor OEM sensor manufacturers will display. Swipe the screen left and right to find the manufacturer of the sensor on the test vehicle, and then enter to the next screen to select the specific OEM sensor number.



Figure 4-30 Sample OEM Senseo Manufacturer Screen



- Or, tap the search box on the top right side of the screen to enter the part number. A soft keyboard will display as below. Enter the OEM Part No. in the search box at the top right corner to complete the operation. Tap  to change the keys to numbers, tap  to change the keys to letters.



Figure 4-31 Sample OEM Part No. Search Screen

- When a specific OEM part No. is selected, the screen will display as pictured below.



Figure 4-32 Sample OEM Part No. Service Menu

NOTE

Only sensor **Check** and **Programming** functions are available with the OEM Part No. function. The **Diagnosis** and **Relearn** functions can only be accessed by selecting a vehicle on the TPMS service menu.

Check

The **Check** tab is the default selection on this menu. Tap **Trigger** on the bottom left of the screen to activate the original sensors and retrieve the sensor information. The original sensor ID, tire pressure, tire temperature, sensor battery, and sensor frequency will populate the displayed table.

NOTE

You can change the unit on the table header according to your preference.



Figure 4-33 Sample Check Screen via OEM Part No.

Programming

The programming function is used to program the sensor data to the MX-Sensor and replace the faulty sensor.

There are three options available when programming MX-Sensor using the OEM Part No. function: **Copy by Activation**, **Copy by Input**, and **Auto Create 1-16 Sensors**. Refer to [Sensor Programming](#) on page 30.

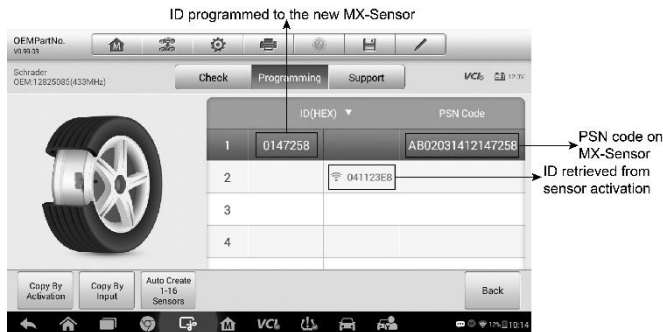

Figure 4-34 Sample Programming Screen via OEM Part No.

The **PSN Code** (Part Serial Number), which is printed on the MX-Sensor, acts as a reference to identify the corresponding sensor ID. This can be especially useful when programming multiple MX-Sensors.

Support

Support will display the correct vehicle types for the selected OEM part number.

To conduct additional procedures such as Diagnosis and Relearn, select the correct test vehicle model and then tap **Enter Vehicle** at the bottom left of the screen. Refer to [TPMS Diagnosis](#) on page 24 and [TPMS Relearn](#) on page 36 for more details about the comprehensive TPMS functions menu.



Figure 4-35 Sample Support Screen

5 Diagnostics

The Diagnostics application, via the MaxiVCI Mini, can access the electronic control module (ECM) for various vehicle control systems, such as engine, transmission, antilock brake system (ABS), airbag system (SRS), view live data parameters and perform active tests.

Getting Started

Ensure a communication link is established between the test vehicle and the tablet via the MaxiVCI Mini. Please refer to [Establish Vehicle Communication](#) on page 24 for details.

Vehicle Menu Layout

When the tablet is properly connected to the vehicle, the platform is ready to start vehicle diagnosis. Tap on the **Diagnostics** application button on the MaxiTPMS Job Menu to access the Vehicle menu.

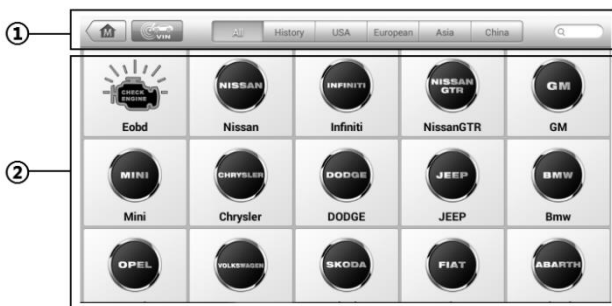

Figure 5-1 Sample Vehicle Menu Screen

1. Top Toolbar Buttons – see [Table 4-1 Top Toolbar Buttons on Vehicle Menu](#) on page 17 for details.
2. Manufacturer Buttons

To begin, select the manufacturer button of the test vehicle, followed by the vehicle model and year.

Vehicle Identification

The MaxiTPMS diagnostic system supports four methods of Vehicle Identification.

1. Auto VIN Scan
2. Manual VIN Input
3. Automatic Selection
4. Manual Selection

Auto VIN Scan

The MaxiTPMS diagnostic system features the VIN-based Auto VIN Scan function to identify vehicles and scan all diagnosable ECUs and run diagnostics on the selected system. This function is compatible with 2006 and newer vehicles.

➤ To perform Auto VIN Scan

1. Tap the **Diagnostics** application button on the MaxiTPMS Job Menu. The Vehicle Menu displays.
2. Tap the **VIN Scan** button on the top toolbar to open the dropdown list.



Figure 5-2 Sample Auto VIN Screen

3. Select **Auto Detect**. Once the test vehicle is identified, the screen will display the vehicle identification number (VIN). Tap **OK** at the bottom right to confirm the VIN. If the VIN does not match with the test vehicle's VIN, enter VIN manually or tap **Read** to acquire VIN again.



Figure 5-3 Sample Auto Detect Screen

4. Review the information. Tap **OK** to confirm the vehicle profile or **NO** to cancel.



Figure 5-4 Sample Vehicle Profile Screen

5. The tool establishes communication with the vehicle and reads the control unit information. Choose **Auto Scan** to scan all the test vehicle available systems or tap **Control Unit** to access a specific system to diagnose.



Figure 5-5 Sample Vehicle Profile Screen

Manual VIN Input

For vehicles not supporting the Auto VIN Scan function, manually enter the vehicle VIN.

➤ To perform Manual VIN Input

1. Tap the **Diagnostics** application button on the MaxiTPMS Job Menu. The Vehicle Menu displays.
2. Tap **VIN Scan** on the top toolbar to open the dropdown list.
3. Select **Manual Input**.
4. Tap the input box and enter the correct VIN.



Figure 5-6 Sample Manual VIN Input

5. Tap **Done**. Once the vehicle is identified the Vehicle Diagnostics screen displays.
6. Tap **Cancel** to exit Manual Input.

Automatic Selection

The Auto VIN Scan can be selected after selecting the test vehicle manufacturer.

➤ To perform Automatic Selection

1. Tap the **Diagnostics** application button on the MaxiTPMS Job Menu. The Vehicle Menu displays.
2. Tap the manufacturer button of the test vehicle.
3. Tap **Automatic Selection** and the VIN information automatically acquired. Follow the on-screen instructions to display the diagnostic screen.

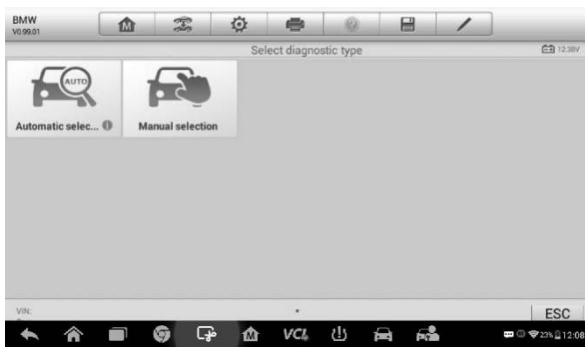

Figure 5-7 Sample Automatic Selection Screen

Manual Selection

When the vehicle's VIN is not automatically retrievable through the vehicle's ECU, or the specific VIN is unknown, the vehicle can manually selected.

This mode of vehicle selection is menu driven, repeat the first two steps from the automatic selection operation and tap **Manual Selection**. Through a series of on-screen prompts and selections the test vehicle is chosen. If

needed, press the **Back** button at the bottom right corner of the screen to return to the previous screen.

Navigation

Navigating the Diagnostics interface and selecting tests is discussed in this section.

Diagnostics Screen Layout

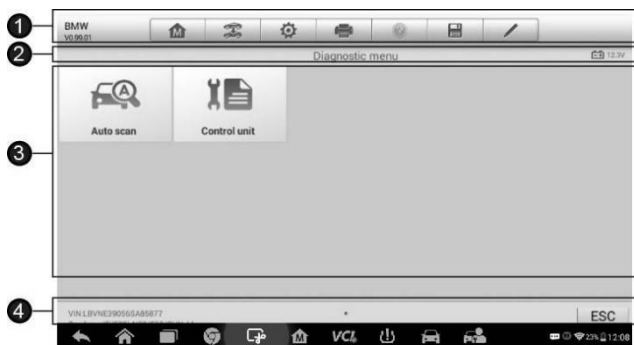

Figure 5-8 Sample Diagnostics Screen

The diagnostic screens typically include four sections.

1. Diagnostics Toolbar
2. Status Information Bar
3. Main Section
4. Functional Buttons

Diagnostics Toolbar

The Diagnostics Toolbar contains a number of buttons such as print and save. Refer to [Table 4-2 Top Toolbar Buttons on Service Menu](#) on page 21 for details.

Status Information Bar

The Status Information Bar at the top of the Main Section displays the following items:

1. Menu Title – displays the menu subject of the Main Section.
2. Voltage Icon – displays the vehicle's voltage status.

Main Section

The Main Section of the screen varies depending on the stage of operations. The Main Section can display vehicle identification selections, the main menu, test data, messages, instructions and other diagnostic information.

Functional Buttons

The displayed Functional Buttons varies depending on the stage of operations. Functional buttons can be used to navigate menus, to save or clear diagnostic data, to exit scanning and to perform a number of other control functions. The use of these buttons will be discussed in detail in the following sections of the corresponding test operations.

Screen Messages

Screen messages appear when additional input is needed before proceeding. There are mainly three main types of on-screen messages: Confirmation, Warning, and Error.

Confirmation Messages

This type of messages usually displays as an "Information" screen, to inform the user that a selected action cannot be reversed or when an action has been initiated and confirmation is needed to continue.

When a user-response is not required to continue, the message displays briefly.

Warning Messages

This type of messages displays a warning that a selected action may result in an irreversible change or loss of data. An example of this type of message is the “Erase Codes” message.

Error Messages

Error messages display when a system or procedural error has occurred. Examples of possible errors include a disconnection or communication interruption.

Making Selections

The Diagnostics application is a menu driven program that presents a series of choices. As a selection is made, the next menu in the series displays. Each selection narrows the focus and leads to the desired test. Tap the screen to make menu selections.

Diagnosis

The Diagnostics application enables a data link to the electronic control system of the test vehicle for vehicle diagnosis or service. The application performs functional tests, retrieves vehicle diagnostic information such as trouble and event codes and live data from various vehicle control systems such as engine, transmission, ABS, and more.

There are two options available when accessing the Diagnosis section:

1. Auto Scan – starts auto scanning for all the available systems on the test vehicle.
2. Control Units – displays a selection menu of all available control units on the test vehicle.

After a section is made and the tablet establishes communication with the vehicle, the corresponding function menu or selection menu displays.

Auto Scan

The Auto Scan function performs a comprehensive scanning of all the systems on the vehicle's ECU to locate systems faults and retrieve DTCs. An example of the Auto Scan interface is pictured below.

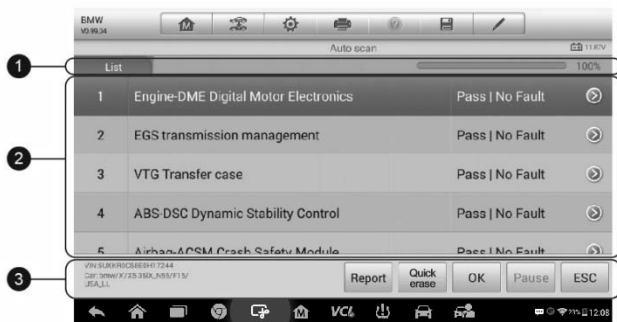

Figure 5-9 Sample Auto Scan Operation Screen

1. Navigation Bar
2. Main Section
3. Functional Buttons

Navigation Bar

1. List Tab – displays the scanned data in list format.
2. Progress Bar – indicates the test progress.

Main Section

Column 1 – displays the system numbers.

Column 2 – displays the scanned systems.

Column 3 – displays the diagnostic indicators describing test results. These indicators are defined as follows:

- ❖ **-!-**: Indicates that the scanned system may not support the code reading function, or there is a communication error between the tester and the control system.
- ❖ **-?-**: Indicates that the vehicle control system has been detected, but the tester cannot accurately locate it.

- ✧ **Fault | #:** Indicates there is/are detected fault code(s) present; “#” indicates the number of the detected faults.
- ✧ **Pass | No Fault:** Indicates the system has passed the scanning process and no fault has been detected.

Column 4 – to perform further diagnosis or testing on a specific system item, tap on the > to the right of that item. A Function Menu screen will display.

Functional Buttons

A brief description of the operations of the Auto Scan’s Functional Buttons’ operations are displayed in the table below.

Table 5-1 Functional Buttons in Auto Scan

Name	Description
Report	Displays the diagnostic data in the report form.
Quick Erase	Deletes codes. A warning message screen will display to inform you of possible data loss when this function is selected.
OK	Confirms the test result. Continues to the system diagnosis after required system is selected by tapping the item in the Main Section.
Pause	Suspends scanning and changes to show the Continue button.
ESC	Returns to the previous screen or exit Auto Scan.

Control Units

Manually locate a required control system for testing through a series of selection choices. Follow the menu driven procedure and make proper selections; the application guides the user to the proper diagnostic function menu based on selections.

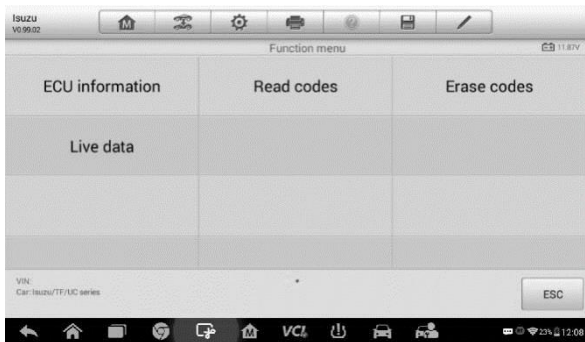

Figure 5-10 Sample Function Menu Screen

The Function Menu options vary slightly for different vehicles. The function menu may include:

- ECU Information – provides the retrieved ECU information in detail. An information screen opens upon selection.
- Read Codes – displays detailed information of DTC records retrieved from the vehicle control module.
- Erase Codes – erases DTC records and other data from the ECU.
- Live Data – retrieves and displays live data and parameters from the vehicle's ECU.

NOTE

Toolbar functions such as saving and printing of test results can be performed throughout diagnostic testing. Data logging and access to help information is also available.

➤ **To perform a diagnostic function**

1. Establish communication with the test vehicle.
2. Identify the test vehicle by selecting from the menu options.
3. Select the **Diagnosis** section.
4. Locate the required system for testing by **Auto Scan** or through menu driven selections in **Control Units**.
5. Select the desired diagnostic function from the **Function Menu**.

ECU Information

This function retrieves and displays the specific information for the tested control unit, including unit type, version numbers and other specifications.

The sample ECU Information screen displays as below:

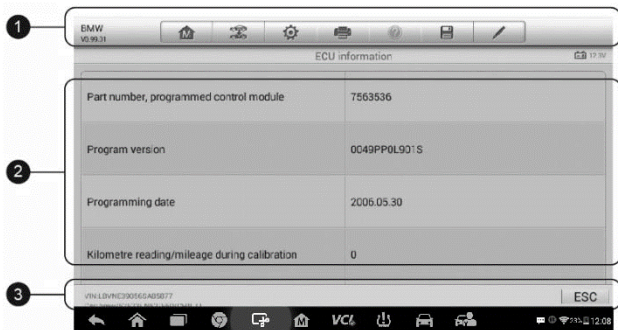

Figure 5-11 Sample ECU Information Screen

1. Diagnostics Toolbar Buttons – see [Table 4-2 Top Toolbar Buttons on Service Menu](#) on page 21 for details.
2. Main Section – the left column displays the item names; the right column shows the specifications or descriptions.
3. Functional Button – **ESC** (or sometimes a **Back**) button is available; tap it to exit after viewing.

Read Codes

This function retrieves and displays the DTCs from the vehicle's control system. The Read Codes screen varies for each vehicle being tested. On some vehicles, freeze frame data can also be retrieved for viewing. The sample Read Codes screen displays as below:

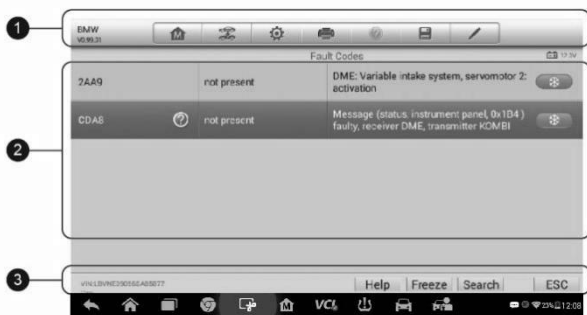

Figure 5-12 Sample Read Codes Screen

1. Diagnostics Toolbar Buttons – see [Table 4-2 Top Toolbar Buttons on Service Menu](#) on page 21 for details.
2. Main Section
 - Code Column – displays the retrieved codes from the vehicle.
 - Status Column – indicates the status of the retrieved codes.
 - Description Column – detailed descriptions of the retrieved codes.
 - Snowflake Icon – displays when freeze frame data is available for viewing; Selecting this icon will display a data screen, which looks and behaves similar to the Read Codes interface.
3. Functional Button
 - Help – tap to view fault code information, including fault description, condition for fault identification, driver information.
 - Freeze – tap to view the freeze frame.
 - Search – tap search for related fault code information on Google.
 - ESC – tap to return to the previous screen or exit the function.

Erase Codes

After reading the retrieved codes and making appropriate vehicle repairs, use this function to erase vehicle codes.

Before performing this function, make sure the vehicle's ignition key is in the ON (RUN) position with the engine off.

➤ **To erase codes**

1. Tap **Erase Codes** from the Function Menu.
2. A warning message displays to advice of data loss if this function is completed.
 - a) Tap **Yes** to continue. A confirming screen displays when the operation is successfully done.
 - b) Tap **No** to exit.
3. Tap **ESC** on the confirming screen to exit Erase Codes.
4. Perform the Read Codes function again to check if the code have been erased successfully.

Live Data

When this function is selected, the screen displays the data list for the selected module. The items available for any control module vary depending on vehicle. The parameters display in the order that they are transmitted by the ECM, so expect variation between vehicles.

Gesture scrolling allows for quick movement through data list. Using one or two fingers, simply swipe the screen up or down to locate the data you want. The figure below shows a typical Live Data screen:

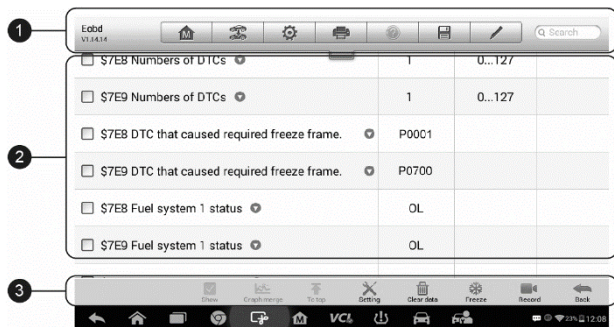

Figure 5-13 Sample Live Data Screen

1. Diagnostics Toolbar Buttons – see [Table 4-2 Top Toolbar Buttons on Service Menu](#) on page 21 for details.
2. Main Section
 - Name Column – this column displays the parameter names.

- a) Check Box – tap the check box at the left side of the parameter name to make item selection. Tap the check box again to deselect the item.
- b) Drop-down Button – tapping the drop-down button at the right side of the parameter name to open a submenu, providing data display mode options.
 - Value Column – displays the values of the parameter items.
 - Unit Column – displays the unit for the parameters.
 - To change the unit mode, tap the **Setting** button on the top toolbar and select a required mode. See [Unit](#) on page 93 for more information.

Display Mode

There are four types of display modes available for data viewing. Select the proper mode for diagnostic purpose.

Tapping the **drop-down button** on the right side of the parameter name to display the sub menu. There are four buttons to configure the data display mode, and a Help button for access to additional information.

Each parameter item displays the selected mode independently.

Analog Gauge Mode – displays the parameters in the form of an analog meter graph.

Text Mode – this is the default mode that displays the parameters in texts, displaying in list format.

NOTE

Status parameters, such as a switch reading, can primarily be viewed in test form such as ON, OFF, ACTIVE, and ABORT. Whereas, value parameters, such as a sensor reading, can be displayed in text mode and additional graph modes.

Waveform Graph Mode – displays the parameters in waveform graphs

When this mode is selected, three control buttons display on the right side of the parameter item for manipulation of display status.

- Text Button – resumes Text Display Mode.
- Scale Button – changes the scale values that are displayed below

the waveform graph. There are four scales available: x1, x2, x4 and x8.

- **Zoom-in Button** – tap once to display the selected data graph in full screen.

Full Screen Display – this option is only available in the waveform graph mode, and primarily used in Graph Merge status for data comparison. Under this mode, there are three control buttons available on the top right side of the screen.

- ✧ **Edit Button** – tap this button opens an edit window, on which you can set the waveform color and the line thickness displayed for the selected parameter item.
- ✧ **Scale Button** – changes the scale values that are displayed below the waveform graph. There are four scales available: x1, x2, x4 and x8.
- ✧ **Zoom-out Button** – exits full screen display.

➤ **To edit the waveform color and line thickness in a data graph**

1. Select 1 to 3 parameter items to display in Waveform Graph mode.
2. Tap the **Zoom-in Button** on the right to display the data graph in full screen.
3. Select a parameter item on the left column.
4. Select a desired sample color from the second column.
5. Select a desired sample line thickness from the right column.
6. Repeat step 3-5 to edit the waveform for each parameter item.
7. Tap **Done** to save the setting and exit, or tap **Cancel** to exit without saving.

Digital Gauge Mode – displays the parameters in form of a digital gauge graph.

3. **Functional Buttons**

The operations of available functional buttons on Live Data screen are described below:

Back – returns to the previous screen or exit the function.

Record – starts recording the retrieved live data; the recorded data is then stored as a video clip in the Data Manager application for future

review. This function can be triggered automatically at preset threshold value or may be set manually. The triggering mode and record duration can be configured in the Setting mode of Live Data.

Freeze – displays the retrieved data in freeze mode.

- Previous Frame – displays previous frame in the freeze data.
- Next Frame – advances to the next frame in the freeze data.

Resume – this button displays when the Record or Freeze function has been selected. Tap this button to set flags on the recorded data at points of interest. When playing back the recorded video clip in *Data Manager*, the preset flag will enable a popup window in which test may be entered.

Clear Data – clears all previously retrieved parameter values at a particular cutting point.

To Top – moves a selected data item to the top of the list.

Graph Merge – tap this button to merge selected data graphs (Waveform Graph Mode only). This function is useful for comparisons between different parameters.

 **NOTE**

In this mode, Graph Merge can only display up to three parameter items.

- To cancel Graph Merge mode, tap the drop-down button on the right side of the parameter name, and select a data display mode.

Show Selected/Show All – tap this option to switch between the two options; one displays the selected parameter items, the other displays all the available items.

Setting – tap this button to access settings menu to set the trigger mode, recording duration and threshold values for data recording, and define other control settings.

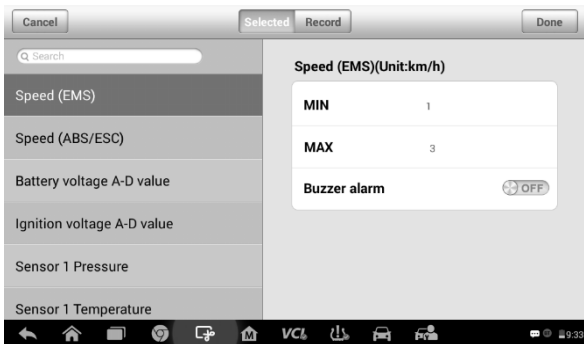

Figure 5-14 Sample Setting Mode in Live Data

There are four navigation buttons on top of the **Setting** mode screen.

- Selected Button – displays the configuration screen to set the threshold values, an upper limit and a lower limit, for triggering the buzzer alarm. This function is only applied to the Waveform Graph display mode.
 - a) MIN – tap to display virtual keyboard and enter the required lower limit value.
 - b) MAX – tap to display virtual keyboard and enter the required upper limit value.
 - c) Buzzer Alarm – switches the alarm on and off. The alarm function makes a beep sound as a reminder whenever the data reading reaches the preset minimum or maximum point.
- **To set threshold limits for the parameter values**
 1. Tap the **Setting** functional button at the bottom of the Live Data screen.
 2. Tap the **Selected** navigation button.
 3. Select a parameter item on the left column, or enter the item name in the Search bar.
 4. Tap on the right side of the **MIN** button, and enter the required minimum value.
 5. Tap on the right side of the **MAX** button, and enter the required maximum value.
 6. Tap the **ON/OFF** button on the right side of the Buzzer Alarm button

to turn it on or off.

7. Tap **Done** to save the setting and return to the Live Data screen; or tap **Cancel** to exit without saving.

If the threshold limits are successfully set, two horizontal lines will appear on each of the data graphs (when Waveform Graph Mode is applied) to indicate the alarming point. The threshold lines are shown in different colors from the waveform of the parameters for distinction.

- Record Button – displays the configuration screen for Record Setting, on which you can set the trigger type, duration and trigger point for the data recording function.
 - a) Trigger Type – sets the trigger mode for data recording, mainly of two kinds: Manual and Auto. There are four options available:
 - 1) Manual – allows you to manually start and stop data recording.
 - 2) DTC – auto triggers data recording when any DTC is detected.
 - 3) DTC Check Mode – auto triggers data recording when certain pre-selected DTC types are detected.
 - 4) Parameter – auto triggers data recording when any parameter value reaches the preset threshold.
 - b) Duration – sets the recording time (for Auto trigger mode only).
 - c) Trigger Point – reserves a relative percentage of a record length before the data recording start point for reference (for Auto trigger mode only).

➤ **To perform setting for live data record**

1. Tap the **Setting** functional button at the bottom of the Live Data screen.
2. Tap the **Record** navigation button.
3. Tap the > button on the right of **Trigger Type** bar and select the required trigger mode.
4. Tap the > button on the right of **Duration** bar and select a length of time.
5. Tap the > button on the right of **Trigger Point** bar and select a relative percentage of a record length to be reserved before the data recording start point.

6. Tap **Done** to save the setting and return to the Live Data screen; or tap **Cancel** to cancel without saving and exit Setting.
- Done Button – confirms and saves the setting, and returns to the Live Data screen.
 - Cancel Button – cancels the setting operation, and returns to the Live Data screen.

Generic OBD II Operations

This option presents a quick way to check for DTCs, isolate the cause of an illuminated malfunction indicator lamp (MIL), check monitor status prior to emissions certification testing, verify repairs, and perform a number of other services that are emissions-related. The OBD direct access option is also used for testing OBD II/EODB compliant vehicles that are not included in the Diagnostics database.

The diagnostics toolbar buttons at the top of the screen function the same as those available for specific vehicle diagnostics. See [Table 4-2 Top Toolbar Buttons on Service Menu](#) on page 21 for details.

General Procedure

- **To access the OBD II/EODB diagnostics functions**
 1. Tap the **Diagnostics** application button on the MaxiTPMS Job Menu. The Vehicle Menu displays.
 2. Tap the **EODB** button. There are two options to establish communication with the vehicle.
 - Auto Scan – when this option is selected, the diagnostic tool attempts to establish communication using each protocol in order to determine the one from which the vehicle is broadcasting.
 - Protocol – when this option is selected, the screen displays a sub menu listing various protocols. A communication protocol is a standardized way of data communication between an ECM and a diagnostic tool. Global OBD may use several different communication protocols.
 3. Select a specific protocol under the **Protocol** option. Wait for the

OBd II Diagnostic Menu to display.



Figure 5-15 Sample OBd II Diagnostic Menu

NOTE

Tap the **i** button beside the function name to an information bubble with additional function information.

4. Select a function option to continue.
 - DTC & FFD
 - I/M Readiness
 - Live Data
 - O2 Sensor Monitor
 - On-Board Monitor
 - Component Test
 - Vehicle Information
 - Vehicle Status

NOTE

Not all functions are supported by all vehicles.

Function Descriptions

This section describes the various functions of each diagnostic option:

DTC & FFD

When this function is selected, the screen displays a list of Stored and Pending Codes. A snowflake button will display on the right side of the DTC item if the Freeze Frame data is available for viewing. Tap **Clear DTC** to erase codes.



Figure 5-16 Sample DTC & FFD Screen

- **Stored Codes**

Stored codes are the current emission-related DTCs from the ECM of the vehicle. OBD II/EOBD Codes have a priority according to their emission severity, with higher priority codes overwriting lower priority codes. The priority of the code determines the illumination of the MIL and the codes erase procedure. Manufacturers rank codes differently, so expect to see differences between makes.

- **Pending Codes**

These are codes that were generated during the last drive cycle, but before the DTC actually sets two or more consecutive drive cycles are needed. The intended use of this service is to assist the service technician after a vehicle repair and after clearing diagnostic information by reporting test results after a driving cycle.

- a) If a test failed during the drive cycle, the DTC associated with that test is reported. If the pending fault does not occur again within 40 to 80 warm-up cycles, the fault is automatically cleared from memory.
- b) Test results reported by this service do not necessarily indicate a faulty component or system. If test results indicate another failure

after additional driving, then a DTC is set to indicate a faulty component or system and the MIL is illuminated.

- **Freeze Frame**

Typically, the stored frame is the last DTC that occurred. Certain DTCs, that have a greater impact on vehicle emission, have a higher priority. In these cases, the top prioritized DTC is the one for which the freeze frame records are retained. Freeze frame data includes a “snapshot” of critical parameter values at the time the DTC is set.

- **Erase Codes**

This option is used to clear all emission related diagnostic data such as DTCs, freeze frame data and manufacturer-specific enhanced data from the vehicle’s ECM, and reset the I/M Readiness Monitor Status for all vehicle monitors to Not Ready or Not Complete status.

A confirmation screen displays when the clear codes option is selected to prevent accidental loss of data. Select **Yes** on the confirmation screen to continue or **No** to exit.

I/M Readiness

This function is used to check the readiness of the monitoring system. It is an excellent function to use prior to having a vehicle inspected for state emissions compliance. Select I/M Readiness to display a sub menu with two choices:

- Since DTCs Cleared – displays the status of monitors since the last time the DTCs are erased.
- This Driving Cycle – displays the status of monitors since the beginning of the current drive cycle.

Live Data

This function displays the real time PID data from ECU. Displayed data includes analog inputs and outputs, digital inputs and outputs, and system status information broadcast on the vehicle data stream.

Live data can be displayed in various modes, see [Live Data](#) on page 58 for detailed information.

O2 Sensor Monitor

This option allows retrieval and viewing of O2 sensor monitor test results for the most recently performed tests from the vehicle's on-board computer.

The O2 Sensor Monitor test function is not supported by vehicles that communicate using a controller area network (CAN). For O2 Sensor Monitor tests results of CAN-equipped vehicles, refer to [On-Board Monitor](#).

On-Board Monitor

Use this option to view the results of On-Board Monitor tests. The tests are useful after servicing or after erasing a vehicle's control module memory.

Component Test

This service enables bi-directional control of the ECM so that the diagnostic tool is able to transmit control commands to operate the vehicle systems. This function is useful in determining whether the ECM responds to a command.

Vehicle Information

The option displays the VIN, the calibration identification, and the calibration verification number (CVN), and other information of the test vehicle.

Vehicle Status

This option is used to check the current condition of the vehicle, including communication protocols of OBD II modules, retrieved codes amount, status of the Malfunction Indicator Light (MIL), and other additional information.

Exiting Diagnostics

The Diagnostics application remains open as long as there is an active communication with the vehicle. Exit the diagnostics operation interface to stop all communications with the vehicle before closing the Diagnostics application.

 **NOTE**

Damage to the vehicle electronic control module (ECM) may occur if communication is disrupted. Make sure all connections, such as USB cable and wireless connection, are properly connected at all times during testing. Exit all tests before disconnecting the test connection or powering down the tool.

➤ **To exit the Diagnostics application**

1. From an active diagnostic screen, tap the **Back** or **ESC** functional button to exit a diagnostic session; Or
2. Tap the **Vehicle Swap** button on the diagnostics toolbar to return to the Vehicle Menu screen.
3. From the Vehicle Menu screen, tap the **Home** button on the top toolbar; or tap the **Back** button on the navigation bar at the bottom of the screen. Or
4. Tap the **Home** button on the diagnostics toolbar to exit the application directly and go back to the MaxiTPMS Job Menu.

Now, the Diagnostics application is no longer communicating with the vehicle and it is safe to open other MaxiTPMS applications, or exit the MaxiTPMS Diagnostic System and return to the Android System's Home screen.

6 Service

The **Service** section is specially designed to provide quick access to the vehicle systems for various scheduled service and maintenance tasks. The typical service operation screen is a series of menu driven executive commands. Follow on-screen instructions to select appropriate execution options, enter correct values or data, and perform necessary actions. The application will display detailed instructions to complete selected service operations.

Currently, the following service functions are available:

- Oil Reset Service
- EPB Service
- BMS Service
- DPF Service
- SAS Calibration Service
- IMMO Keys
- Other functions coming soon

After entering each special function, the screen will display two application choices: **Diagnosis** and **Hot Functions**. The **Diagnosis** enables the reading and clearing of codes which is sometimes necessary after completing certain special functions. **Hot Functions** consists of sub functions of the selected special function.

Oil Reset Service

Perform reset for the Engine Oil Life system, which calculates an optimal oil life change interval depending on the vehicle driving conditions and climate. The Oil Life Reminder must be reset each time the oil is changed, so the system can calculate when the next oil change is required.

! IMPORTANT

Always reset the engine oil life to 100% after every oil change.

NOTE

1. All required work must be carried out before the service indicators are reset. Failure to do so may result in incorrect service values and cause DTCs to be stored by the relevant control module.
2. For some vehicles, the scan tool can reset additional service lights such as maintenance cycle and service interval. On BMW vehicles for example, service resets include engine oil, spark plugs, front/rear brakes, coolant, particle filter, brake fluid, micro filter, vehicle inspection, exhaust emission inspection and vehicle checks.

➤ To perform oil reset functions

1. Tap the **Service** application button on the MaxiTPMS Job Menu.
2. Tap **Oil Reset** button. The vehicle manufacturer screen displays. Tap **VIN Scan** or the vehicle make to acquire vehicle VIN information and tap **Yes** to confirm. See [Vehicle Identification](#) on page 46 for details.
3. Tap the desired function in the Oil Reset function list. The list may vary by test vehicle.

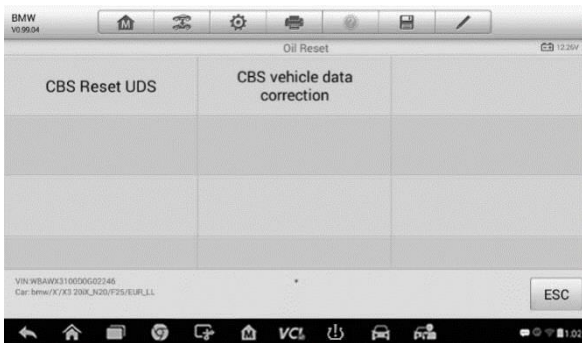

Figure 6-1 Sample Oil Reset Function List

4. Follow the step-by-step on-screen instruction to complete the service. Using CBS Reset UDS as an example.
5. Tap **CBS Reset UDS** on the Oil Reset function list to start the operation. The screen will display the date and time and ask for confirmation. If the displayed date and time are correct, tap **Yes** to

confirm. If no, tap **No** and go to the Settings menu to set the correct date and time.

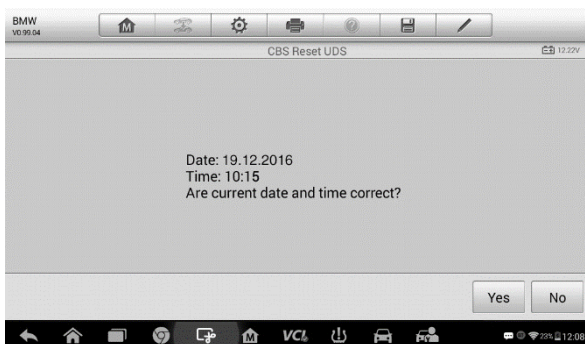

Figure 6-2 Sample Oil Reset Service Screen 1

6. The available items will display in a table of three columns: CBS value, availability, and service counter.



Figure 6-3 Sample Oil Reset Service Screen 2

7. Tap on the value to reset and then tap the **Reset** button on the bottom right of the screen.

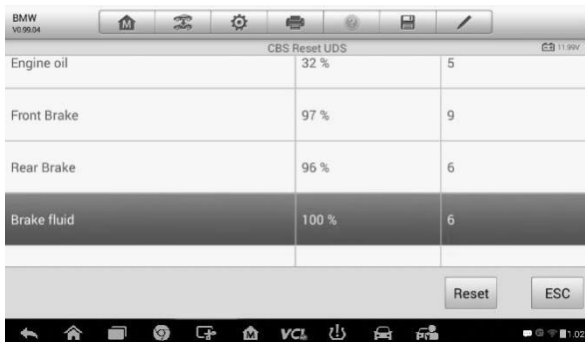

Figure 6-4 Sample Oil Reset Service Screen 3

- When the reset is done, the availability will display as 100%. Tap **ESC** to exit.

Electric Parking Brake (EPB) Service

This function has a multitude of usages to maintain the electronic braking system safely and effectively. The applications include deactivating and activating the brake control system, assisting with brake fluid control, opening and closing brake pads, and setting brakes after disc or pad replacement.

EPB Safety

It can be dangerous to perform Electric Parking Brake (EPB) system maintenance, so before you begin the service work, please keep these rules in mind.

- ✓ Ensure that you are fully familiar with the braking system and its operation before commencing any work.
- ✓ The EPB control system may be required to be deactivated before carrying out any maintenance/diagnostic work on the brake system. This can be done from the tool menu.
- ✓ Only perform maintenance work when the vehicle is stationary and on level ground.
- ✓ Ensure that the EPB control system is reactivated after the maintenance work has been completed.

NOTE

Autel accepts no responsibility for any accident or injury arising from the maintenance of the Electric Parking Brake system.

➤ To perform EPB functions

1. Tap the **Service** application button on the MaxiTPMS Job Menu.
2. Tap **EPB** button. The vehicle manufacturer selection screen will display. Tap **VIN Scan** or the vehicle manufacturer to acquire vehicle VIN information and tap **Yes** to confirm. See [Vehicle Identification](#) on page 46 for details.
3. Tap the desired service in the EPB function list. The list may vary for different vehicles being tested.

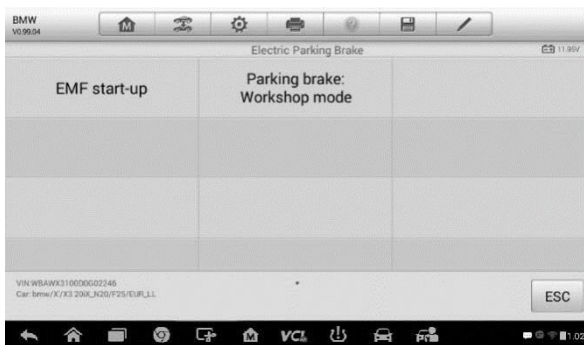

Figure 6-5 Sample EPB Function List

4. Follow the step-by-step on-screen instruction to complete the service.
5. Press **OK** button to exit.

EMF Start-up

This service function would start the parking brake. It must be conducted after the following repairs:

- Replacing an EMF control unit.
- Replacing the parking brake button.

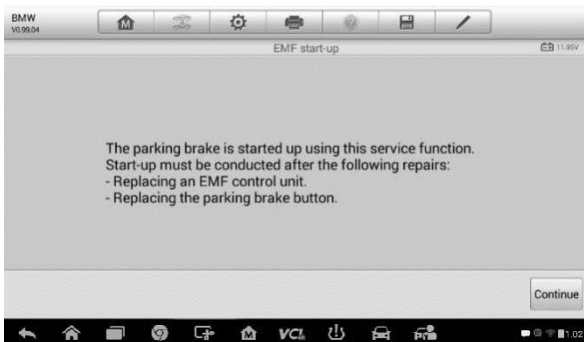

Figure 6-6 Sample EMF Star-up Screen 1

- 1) Tap **Continue** to proceed with this service function or tap **Back** at the bottom left to exit.
- 2) Tap on the completed action to continue.

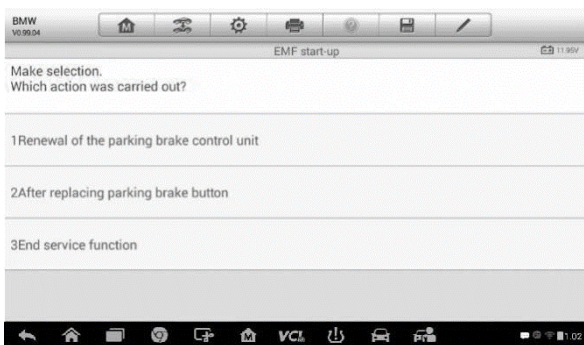

Figure 6-7 Sample EMF Star-up Screen 2

- 3) The following screen will display a message to advise that the fault memory of the parking brake control unit will be deleted, press **Continue** to proceed or **Back** to exit.

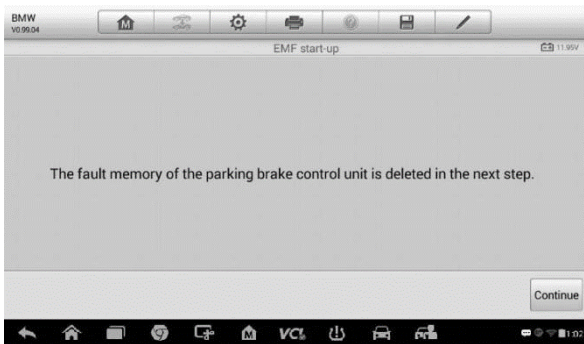

Figure 6-8 Sample EMF Star-up Screen 3

- 4) Follow the on-screen instructions to pull the parking brake button. Wait for appropriately three seconds until the parking brake is set. When the operation is successfully completed, a “Completed successfully” message will display on the screen, press **OK** to exit.

Parking Brake: Workshop Mode

This service is used to activate and deactivate the installation position for the Automatic Hold brake. In this mode the parking brake is moved into the opened position and temporarily deactivated (personal protection).

The installation position must be activated for the following repairs:

- Replacement of brake pads.
- Replacement of a brake caliper.
- Replacement of an actuator.

Select **Parking Brake: Workshop Mode** and follow the on-screen instructions to perform a series of operations to initiate the brake pad after replacement.

When the operation is successfully completed, a “Completed successfully” message will appear on the screen. Press **OK** to exit.

Battery Management System (BMS) Service

The Battery Management System (BMS) allows the scan tool to evaluate the battery charge state, monitor the close-circuit current, register the battery

replacement, activate the rest state of the vehicle, and charge the battery via the diagnostic socket.

 **NOTE**

1. This function is not supported by all vehicles. The screens shown in this section are examples.
 2. The sub functions and actual test screens of the BMS may vary by vehicle, please follow the on-screen instructions to make correct option selection.
-

The vehicle may use either a sealed lead-acid battery or an AGM (Absorbed Glass Mat) battery. Lead acid battery contains liquid sulphuric acid and can spill when overturned. AGM battery (known as VRLA battery, valve regulated lead acid) also contains sulphuric acid, but the acid is contained in glass mats between terminal plates.

It is recommended that the replacement aftermarket battery has the same specifications, such as capacity and type, as the exiting battery. If the original battery is replaced with a different type of battery (e.g. a lead-acid battery is replaced with an AGM battery) or a battery with a different capacity (mAh), the vehicle may require reprogramming of the new battery type, in addition to, performing the battery reset. Consult the vehicle manual for additional vehicle-specific information.

Register Battery Replacement

This option displays the mileage reading of last battery was replaced, registers the battery replacement after replacing a new battery and informs the power management system that a new battery has been installed.

If the battery change is not registered, the power management system will not function properly, which may not provide the battery with enough charging power to operate the car or limit the functionality of vehicle's electrical systems.

Take **BMW** as an example.

➤ **To display the battery history**

1. Tap the **Service** application button on the MaxiTPMS Job Menu.
2. Tap **BMS** button. The vehicle manufacturer selection screen displays. Tap **VIN Scan** or the vehicle manufacturer to acquire

vehicle VIN information and tap **Yes** to confirm. See [Vehicle Identification](#) on page 46 for details.

3. Tap **Register Battery Replacement** in the BMS function list, the list may vary by test vehicle.

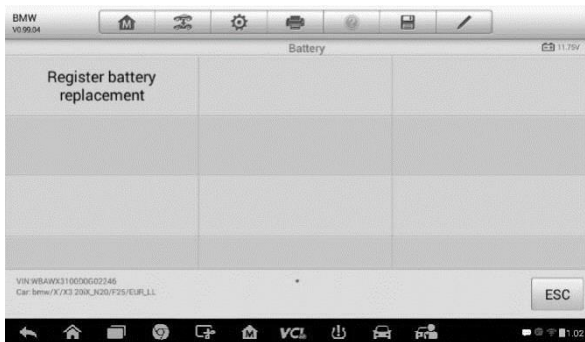

Figure 6-9 Sample BMS Function List

4. Tap on the desired service. In this example, Tap function 2 (**F2**) to choose the function **Battery exchange history display**. A notice screen displays.



Figure 6-10 Sample BMS Screen 1

5. Read carefully the complete information and press **Continue**.

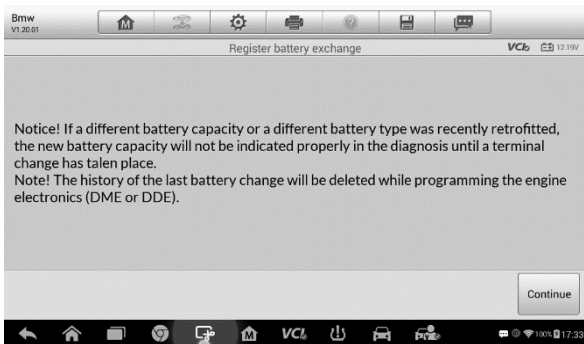

Figure 6-11 Sample BMS Screen 2

6. Check the battery capacity and the battery replacement information on the screen.
7. Tap function 1 (F1) to return to the selection screen.

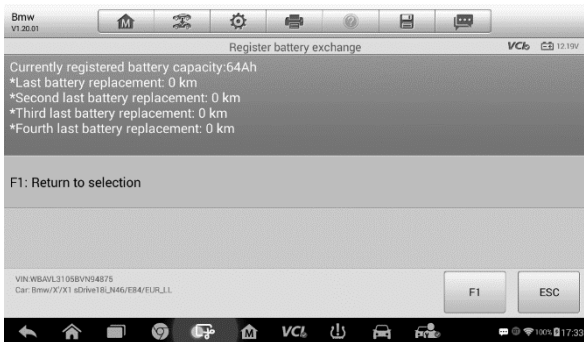

Figure 6-12 Sample BMS Screen 3

➤ **To register the battery replacement**

1. Tap on the appropriate step to complete. In our example, tap function 1 (F1) **Register battery replacement**.

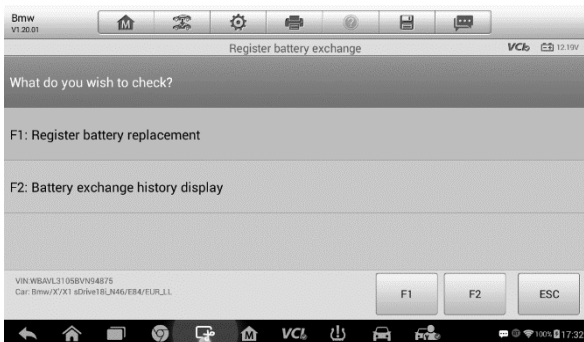

Figure 6-13 Sample BMS Screen 4

2. Read carefully the information on the screen. Scroll through lists to view all the functions.

There are three functions. Select function 1 (F1) for example.

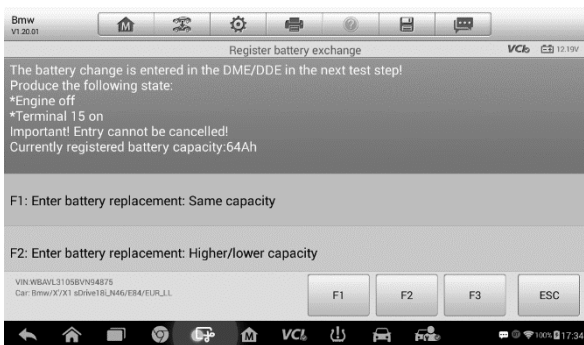

Figure 6-14 Sample BMS Screen 5

- 1) Enter battery replacement: same capacity
- 2) Enter battery replacement: different capacity
- 3) Enter battery replacement: Changing from the normal lead-acid battery (white housing) to AGM battery (black housing)

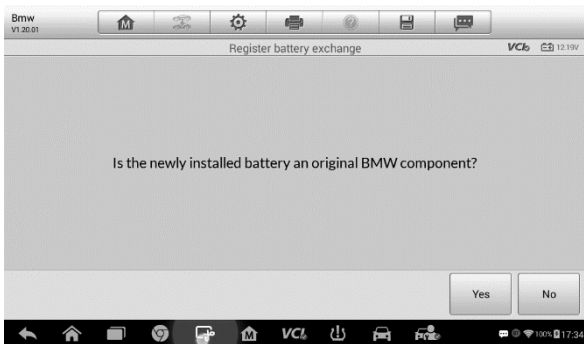

Figure 6-15 Sample BMS Screen 6

3. Read carefully the information on the screen and tap **Yes** to continue.
4. Follow the on-screen instructions to input the data matrix code of the newly installed battery that should be on the label of the battery. Tap **OK** to continue.

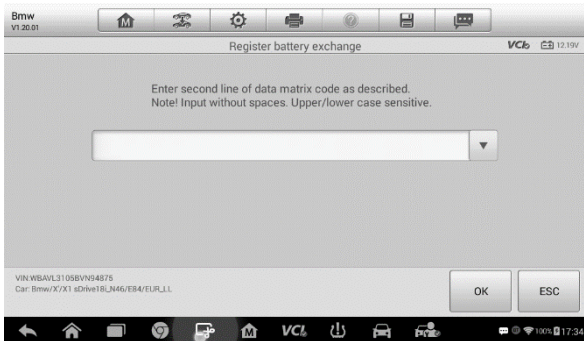

Figure 6-16 Sample BMS Screen 7

5. When the battery exchange is successfully entered, tap **Continue** to exit.

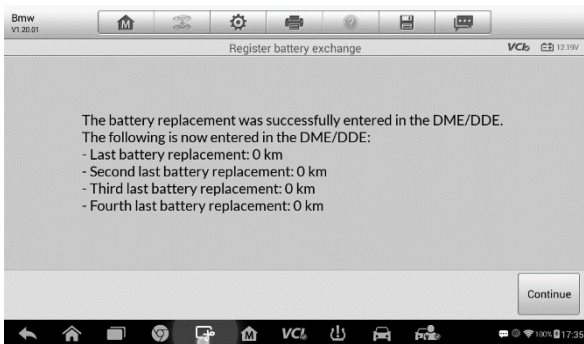

Figure 6-17 Sample BMS Screen 8

Steering Angle Sensor (SAS) Service

Steering Angle Sensor Calibration permanently stores the current steering wheel position as the straight-ahead position in the steering angle sensor EEPROM. Therefore, the front wheels and the steering wheel must be set exactly to the straight-ahead position before calibration. In addition, the vehicle identification number (VIN) is also read from the instrument cluster and stored permanently in the steering angle sensor EEPROM. On successful completion of calibration, the steering angle sensor fault memory is automatically cleared.

Calibration must always be carried out after the following operations:

- Steering wheel replacement
- Steering angle sensor replacement
- Any maintenance that involves opening the connector hub from the steering angle sensor to the column
- Any maintenance or repair work on the steering linkage, steering gear or other related mechanism
- Wheel alignment or wheel track adjustment
- Accident repairs where damage to the steering angle sensor or assembly, or any part of the steering system may have occurred

NOTE

1. Autel accepts no responsibility for any accident or injury arising from servicing the SAS system. When interpreting DTCs retrieved from the vehicle, always follow the manufacturer's recommendation for repair.
2. All software screens shown in this manual are examples, actual test screens may vary by test vehicle. Pay attention to the menu titles and onscreen instructions to make correct option selections.
3. Before starting procedure, make sure vehicle has ESC. Look for button on dash.

Using a **Land Rover** as an example.

1. Tap the **Service** application button on the MaxiTPMS Job Menu.
2. Tap **SAS** button. The vehicle manufacturer selection screen displays. Tap **VIN Scan** or the vehicle manufacturer to acquire vehicle VIN information and tap **Yes** to confirm. See [Vehicle Identification](#) on page 46 for details.
3. Tap the desired service in the SAS function list, the list may vary by test vehicle.

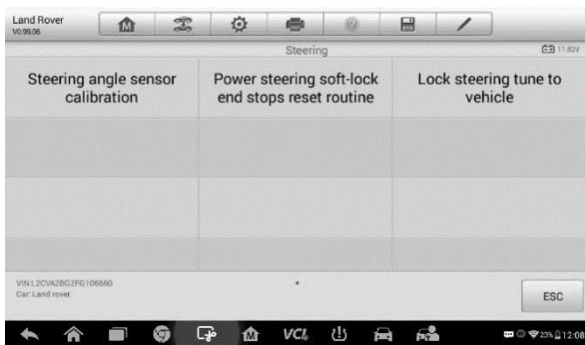

Figure 6-18 Sample SAS Function Menu

Steering Angle Sensor Calibration

This function allows users to perform steering angle sensor calibration, clear records and clear counter. The function options vary by vehicle.

- 1) Tap **Steering Angle Sensor Calibration** from the SAS function menu to enter the function screen.
- 2) Follow the on-screen instructions to set the ignition on/off as guided. The vehicle battery voltage signal should be in the range 12.5 – 13.5 volts to proceed with this service, otherwise the scan tablet will display a warning message.
- 3) Ensure the steering wheel is in the central position and the front wheels are in the straight position. Then tap **OK** to proceed.

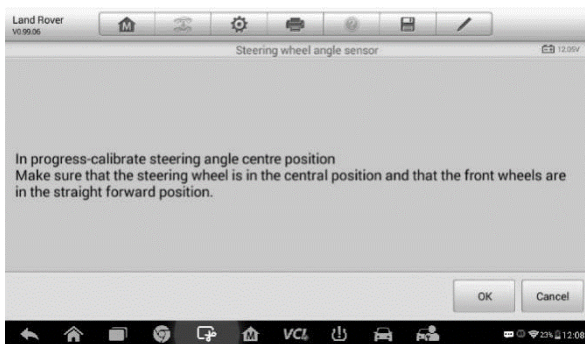

Figure 6-19 Sample SAS Function Screen 1

- 4) When the operation is finished, the scan tool will display a confirmation message. An error message will display if the procedure cannot be completed. Exit the diagnosis program, and solve the error before attempting SAS calibration again.

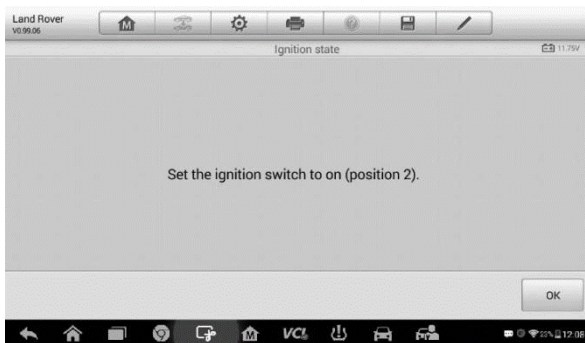

Figure 6-20 Sample SAS Function Screen 2

Diesel Particle Filter (DPF) Service

The Diesel Particle Filter (DPF) function manages DPF regeneration, DPF component replacement teach-in and DPF teach-in after replacing the engine control unit.

The ECM monitors driving style and selects a suitable time to employ regeneration. Cars driven a lot at idling speed and low load will attempt to regenerate earlier than cars driven more with higher load and speed. In order for regeneration to take place, a prolonged high exhaust temperature must be obtained.

In the event of the car being driven in such a way that regeneration is not possible, i.e., frequent short journeys, a diagnostic trouble code will eventually be registered in addition to the DPF light and "Check Engine" indicators displaying. A service regeneration can be requested in the workshop using the diagnostic tool.

Before performing a forced DPF regeneration using the tool, check the following items:

- The fuel light is not on.
- No DPF-relevant faults are stored in system.
- The vehicle has the specified engine oil.
- The oil for diesel is not contaminated.

IMPORTANT

Before diagnosing a problem vehicle and attempting to perform an emergency regeneration, it is important to obtain a full diagnostic log and read out relevant measured value blocks.

NOTE

1. The DPF will not regenerate if the engine management light is on, or there is a faulty EGR valve.
2. The ECU must be re-adapted when replacing the DPF and when topping up the fuel additive Eolys.
3. If the vehicle needs to be driven in order to perform a DPF service, a second person is needed for the function. One person should drive the vehicle while the other person observes the screen on the Tool. Do not

attempt to drive and observe the scan tool at the same time. This is dangerous and puts your life and the lives of other motors and pedestrians at risk.

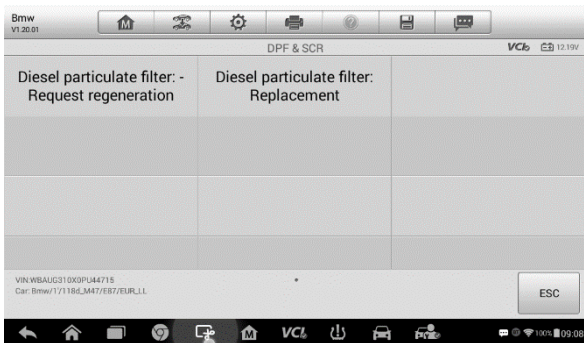

Figure 6-21 Sample DPF Service Function Menu

Diesel Particulate Filter: Replacement

Tap on the desired service. In this example, the second function enables replace the diesel particulate filter. The function options vary by vehicle.

1. Tap **Diesel Particulate Filter: Replacement** from the service functions menu to enter the service screen.

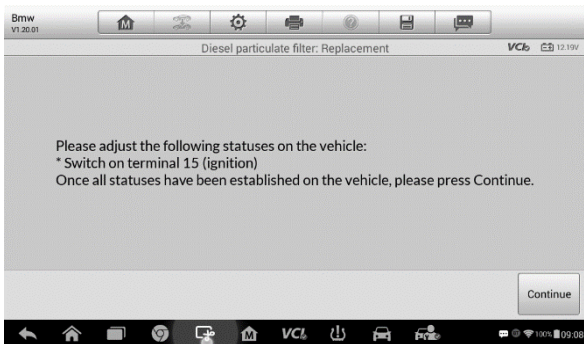

Figure 6-22 Sample Diesel Particulate Filter Screen 1

2. Make sure the statuses on the vehicle are adjusted to the required level. Press **Continue**.
3. Read carefully the information on the screen and press **Continue**.

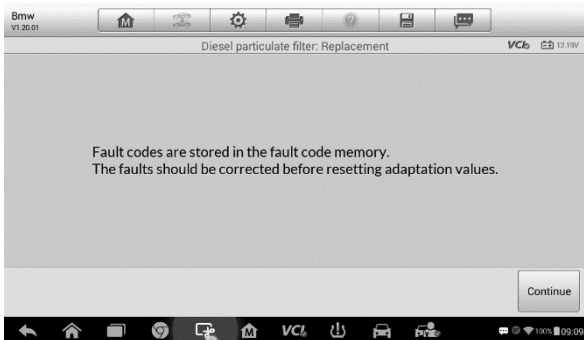

Figure 6-23 Sample Diesel Particulate Filter Screen 2

4. Tap function 1 (**F1**) to reset adaptation values for the particle filter.

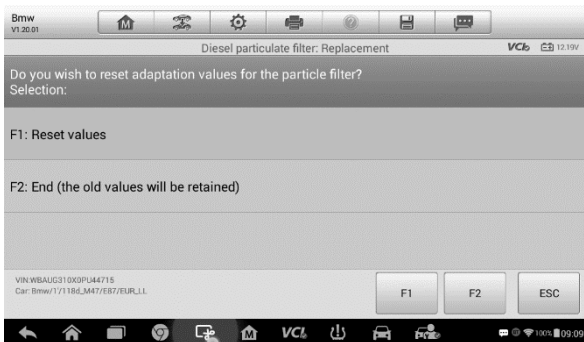

Figure 6-24 Sample Diesel Particulate Filter Screen 3

5. Read carefully the information on the screen and tap **Yes** to continue.

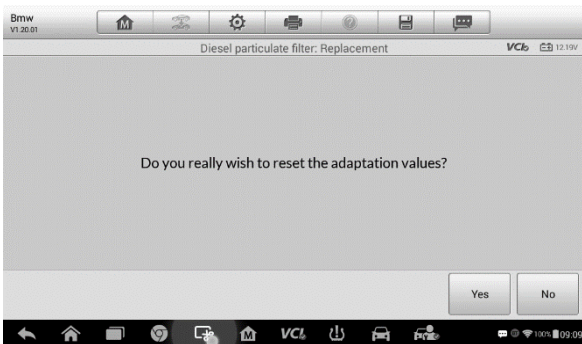

Figure 6-25 Sample Diesel Particulate Filter Screen 4

6. The adaptation values are reset successfully. Tap **Continue** to end the service function.

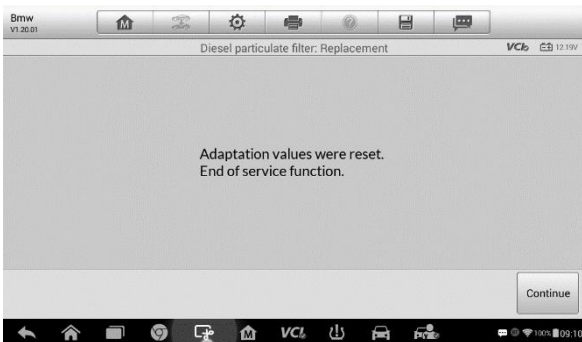

Figure 6-26 Sample Diesel Particulate Filter Screen 5

Immobilizer (IMMO) Service

An immobilizer is an anti-theft mechanism that prevents an automobile's engine from starting unless the correct ignition key or other device is present. This device prevents thieves from starting the car by a method known as hot wiring. Most new vehicles have an immobilizer as standard equipment. An important advantage of this system is that it doesn't require the car owner to activate it; it operates automatically. An immobilizer is considered as providing much more effective anti-theft protection than an audible alarm

alone; many auto insurance companies offer lower rates for vehicles that are equipped with an immobilizer.

As an anti-theft device, an immobilizer disables one of the systems needed to start a car's engine, usually the fuel supply or the ignition. This is accomplished by radio frequency identification between a transponder in the ignition key and a device called a radio frequency reader in the steering column. When the key is placed in the ignition, the transponder sends a signal with a unique identification code to the reader, which relays it to a receiver in the vehicle's computer control module. If the code is correct, the computer allows the fuel supply and ignition systems to operate and start the car. If the code is incorrect or absent, the computer disables the system, and the car will be unable to start until the correct key is placed in the ignition.

The IMMO service can disable a lost vehicle key and program the replacement key fob. One or more replacement key fobs can be programmed.

➤ **To program the replacement key fob(s)**

1. Tap **IMMO KEYS** after entering the **Service** function from the MaxiTPMS Job Menu.
2. Tap **Automatic Selection** or **Manual Selection** to acquire vehicle VIN information and tap **Yes** to confirm. See [Vehicle Identification](#) on page 46 for details.
3. Tap **Erase/Program all key fobs** in the IMMO function list once displayed, the list may vary by test vehicle.

 **NOTE**

1. To complete key fob programming, the Security Code will be required. This can be done through the Security Code Read function in hot functions.
 2. Before programming, please check and erase the fault codes.
-
4. Read the on-screen information carefully and follow the instructions to complete the operation.

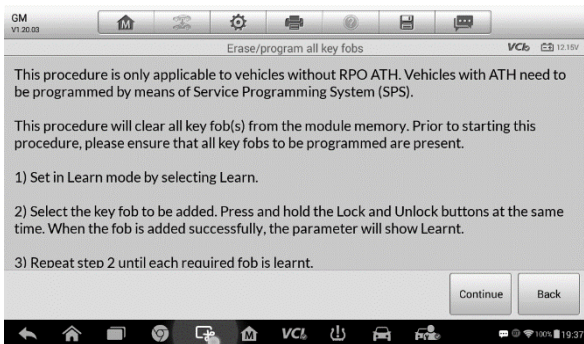

Figure 6-27 Sample IMMO Note Screen

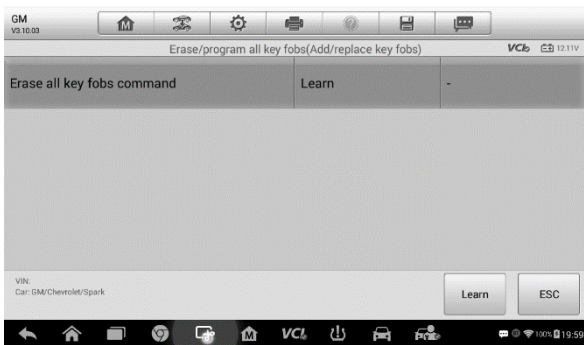

Figure 6-28 Sample Program Key FOB Screen

7 ToolKit

This chapter describes auxiliary functions for TPMS service and vehicle diagnosis.

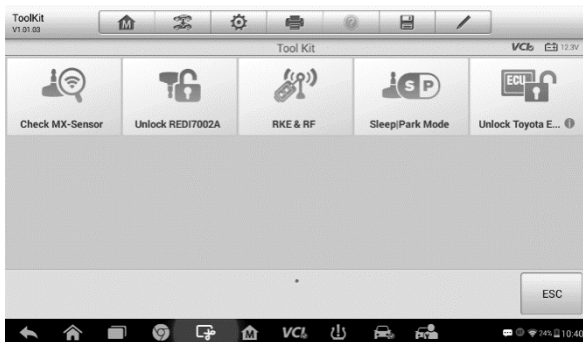

Figure 7-1 Sample ToolKit Screen

1. Check MX-Sensor

This function is used to activate and display the data on a MX-Sensors.

- Place the MX-Sensor at the top right corner of the tablet and then tap **Check**, the detailed information of the sensor will display.
- Tap **ESC** to exit.

2. Unlock REDI7002A

This function is used to unlock the specified Redi-sensor: 7002A.

3. RKE & RF

This function is used to check the signal strength of 315 and 433 MHz frequencies of remote keyless entry Fobs.

4. Sleep | Park Mode

For those OEM sensors that are delivered in Sleep Mode, this function is used to wake and set them to Park Mode.

5. Unlock Toyota ECU

Some Toyota ECU may be locked by default, use this function to unlock the ECU before performing any ECU-related operations.

8 Settings

Tap the Settings button to adjust the default settings and view information about the MaxiTPMS system:

- Unit
- Language
- Printing Setting
- Notification Center
- Auto Update
- About
- System Settings

This section describes the procedures to adjust the device's system settings.

Unit

This option allows you to adjust the measurement unit for the diagnostic system.

➤ To adjust the unit setting

1. Tap the **Settings** application on the MaxiTPMS Job Menu.
2. Tap the **Unit** option on the left column.
3. Select the desired measurement unit, Metric or English. A tick icon will display to the right of the selected unit.
4. Tap the **Home** button on the top left corner to return to the MaxiTPMS Job Menu. Or tap another setting to adjust.

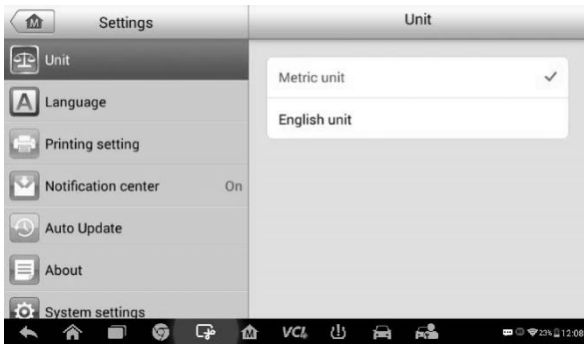

Figure 8-1 Sample Unit Setting Screen

Language

Select the appropriate display language for the MaxiTPMS system.

➤ **To adjust the language setting**

1. Tap the **Settings** application on the MaxiTPMS Job Menu.
2. Tap the **Language** option on the left column.



Figure 8-2 Sample Language Setting Screen

3. Select the required language. A check will display to the right of the selected language.
4. Tap the **Home** button on the top left corner to return to the MaxiTPMS Job Menu. Or tap another setting to adjust.

Printing Setting

Configure this option to enable the tablet to print through a specified network.

➤ **To setup the printer connection**

1. Tap the **Settings** application on the MaxiTPMS Job Menu.
2. Tap the **Printing Setting** option on the left column.
3. Tap the **Print via Network** to activate the printing function, enabling the device to send files to the printer through the networked PC via Wi-Fi connection.
4. Tap the **Home** button on the top left corner to return to the MaxiTPMS Job Menu, or tap another setting to adjust.

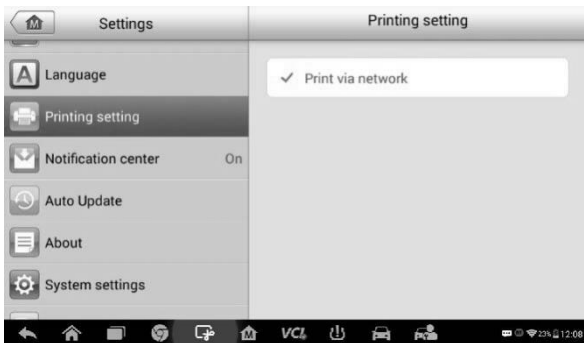

Figure 8-3 Sample Printing Setting Screen

Printing via APP

TS608 can print to WiFi printer via a downloaded app.

On the tablet, click on the **Print** button of a saved file and the file will print to the connected printer.

Printing via PC

If the Wi-Fi printer is not available, you can also use your PC to print the data on the tablet. Follow the instructions.

➤ **To install the printer driver program to a computer**

1. Download the **Maxi PC Suite** from www.autel.com or www.maxitpms.com to a Windows-based computer.
2. Double click on **Setup.exe** item.
3. Select the installation language and the wizard will load momentarily.
4. Follow the instructions on the screen and click **Next** to continue.
5. Click on **Install** and the printer driver program will be installed onto the computer.
6. Click on **Finish** to complete the installation.

NOTE

The MaxiSys Printer runs automatically after the installation.

The computer, printer and the tablet must be connected to the same network.

➤ **To print via a computer**

1. Run the **MaxiSys Printer** program on the computer.
2. Click **Test Print** to make sure the printer is working successfully.
3. Tap the **Print** button on the toolbar. A test document will automatically be sent to the computer for printing when the **Auto Print** option is selected.
4. Tap the **Print** button on the toolbar of the tablet. A test document will be sent to the computer.
 - ✧ If the **Auto Print** option in the MaxiSys Printer is selected, the MaxiSys Printer will print the received document automatically.
 - ✧ If the **Auto Print** option is not selected, click **Open PDF File** button to view all the temporary files. Select the file(s) to print and click **Print**.

Notification Center

The Notification Center function configures the MaxiTPMS tablet to receive regular on-line messages from the server for system update notifications or other service information via the Internet. It is highly recommended to keep this function ON all the time, to ensure notifications of update are received. Internet access is required for receiving on-line messages.

➤ **To enable the Notification Center function**

1. Tap the **Settings** application on the MaxiTPMS Job Menu.
2. Tap the **Notification Center** option on the left column.

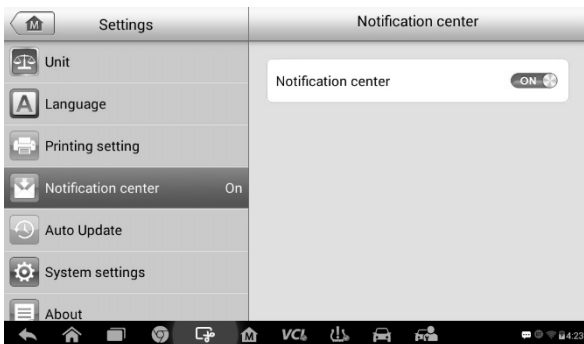

Figure 8-4 Sample Notification Center Screen

3. Tap the **ON/OFF** button to enable or disable the Notifications function. If the function is enabled the button turns blue, if disabled the button turns gray.
4. Tap the **Home** button on the top left corner to return to the MaxiTPMS Job Menu or choose another setting to adjust.

When the Notification Center function is turned on, and new messages are received by the MaxiTPMS device, a notification message displays on the MaxiTPMS Job Menu. Press on the message bar and drag it down, and the received messages are shown in the list. Swipe up or down to view all if the message list populates additional screens.

Tap a specific message to launch the corresponding application. For example, tap on an Update notification message and the Update application will launch.

Auto Update

The Auto Update allows the tool to automatically update the OS, the MaxiTPMS system, and the Vehicle coverage software. Each can be configured to update automatically and at specified times. Tap the **ON** button and set the desired automatic update time.

- **To set auto system or vehicle update**

1. Tap the **Settings** application on the MaxiTPMS Job Menu.
2. Tap the **Auto Update** option on the left column. The three auto update items display on the right.
3. Select the update type to schedule. Toggle the button to ON.

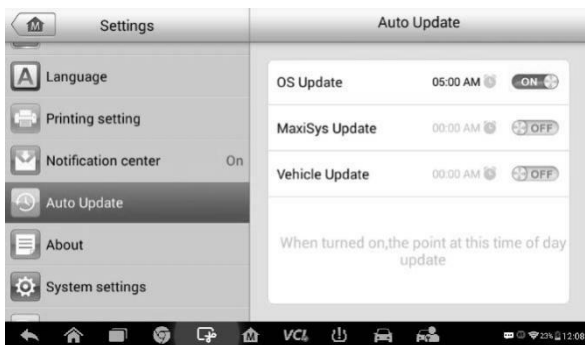

Figure 8-5 Sample Auto Update Screen

4. To set download time, use the **+** and **-** buttons or tap on the numbers and the manual input screen will display. Tap **Done** to complete the time setting.

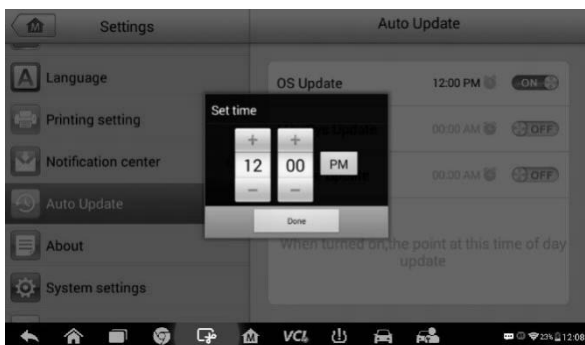

Figure 8-6 Sample Set Time Screen

NOTE

The tool must be connected to the Internet at the time download is scheduled.

System Settings

Access the Android system setting inter face to adjust background system settings including wireless and network settings, sound and display screen settings and system security settings.

➤ **To enable the App Switcher function**

1. Tap the **Settings** application on the MaxiTPMS Job Menu.
2. Tap the **System settings** option on the left column.

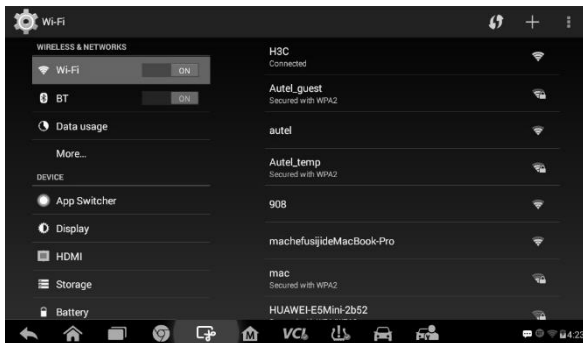

Figure 8-7 Sample System Setting Screen

3. Tap the **App Switcher** option on the left column.
4. Check the box beside “Always show the App Switcher” on the right side of the screen, then the App Switcher icon will display.

Short press the App Switcher icon opens a control panel:

- Tap a specific app shortcut button to access selected application screen.
- Long press a specific app shortcut button to display the app menu. The shortcut can be altered here.
- Press and drag the App Switcher icon to alter the icons position on the screen.

Refer to the Android documentation for additional information on Android system settings.

About

About displays information regarding the MaxiTPMS diagnostic device including the product name, version, hardware, and the device's serial number.

- **To check the MaxiTPMS product information in About**
 1. Tap the **Settings** application on the MaxiTPMS Job Menu.
 2. Tap **About** on the left column. The product information screen displays on the right.
 3. Tap **Home** on the top left corner to return to the MaxiTPMS Job Menu, or select another setting to adjust.

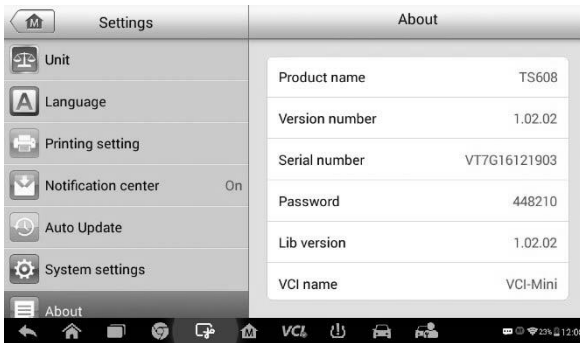

Figure 8-8 Sample About Screen

9 Update

This chapter describes the update operation for both the TS608 tablet and the MaxiVCI Mini. The software and firmware updates of the tablet can be completed on the tablet via the Internet, while the updates for MaxiVCI Mini can be completed either by connecting to a tablet or by connecting with a PC.

Display Tablet Update

The Update application on the tablet downloads the latest released software. The updates improve the MaxiTPMS applications' capabilities, typically by adding new tests, new vehicle coverage and/or by adding enhanced database applications.

Software Update

When connected to Internet, the tablet automatically searches for available updates. Updates can be downloaded and installed on the device. This section describes update procedures in the MaxiTPMS system. When the Notifications Center function is enabled in the Settings application (See [Notification Center](#) page 96 for details), a notification message will display when updates are available.



Figure 9-1 Sample Update Screen

1. Navigation and Controls

- Home Button – returns to the MaxiTPMS Job Menu.
- Update All – downloads all available updates.
- Diagnostics Tab – displays all available vehicle diagnostic software.
- TPMS Tab – displays all available TPMS service software for vehicles.
- Search Bar – searches specific update item by inputting the file name. Example: enter a vehicle manufacturer.

2. Status Bar

- Left Side – displays the MaxiTPMS device model information and serial number.
- Right Side – displays an update progress bar indicating the completion status.

3. Main Section

- Left Column – displays vehicle buttons and update software version.
- Middle Column – displays a brief introduction about the new changes to the software operation or capabilities. Tap **i** button to open an information screen to view more details, and tap the dim area around to close the window.
- Right Column – according to the operation status of each software

item, the button displays differently.

- a) Tap **Update** to update the selected item.
- b) Tap **Pause** to suspend the updating procedure.
- c) Tap **Continue** to go on updating the suspended update.

➤ **To update the diagnostic software and TPMS service software**

1. Ensure the tablet is connected to a power source and has a stable connection with the Internet.
2. Tap the **Update** application button on the MaxiTPMS Job Menu; or tap the received notification message; or tap the Update icon on the Vehicle Menu in Diagnostics application. The Update application screen displays.
3. Check all available updates:
 - If you decide to update all the items of diagnostic software, select **Diagnostics** Tab and then tap the **Update All** button; if you want to update all TPMS service software, select **TPMS** Tab and then tap the **Update All** button.
 - If you only want to update one or some of the item(s), tap the **Update** button on the right column of the specific item(s).
4. Tap the **Pause** button to suspend the updating process. Tap **Continue** to resume updating and the process will resume from the break point.
5. When the updating process is completed, the firmware will be installed automatically. The previous version will be replaced.

There is NO separate download button for the tablet's firmware. The firmware is downloaded with the software package.

An update firmware message will display to remind you to install the firmware when a vehicle manufacturer is chosen in the TPMS menu.

MaxiVCI Mini Update

Update via Display Tablet

Before updating the VCI software, ensure the tablet's network connection to the Internet is stable.

➤ **To update the MaxiVCI Mini software**

1. Power on the tablet.
2. Connect the MaxiVCI Mini to the tablet via USB.
3. Tap the **VCI Manager** application on the MaxiTPMS Job Menu of the tablet.
4. Select **Update** from the connection mode list.
5. The current version and the latest version of the VCI software will be display, click **Update Now** to update the VCI software if an update is available.

Update via PC

1. Download the **Maxi PC Suite** from www.autel.com > Support & Updates > Firmware Downloads > Update Client, or from www.maxitpms.com > Support > Freshdesk > Firmware & Downloads > Update Client. Install the software on a Windows-based PC.
2. Using a USB cable, connect the MaxiVCI Mini to a PC.
3. Launch **Maxi PC Suite** on the PC and click on MaxiVCI Mini icon in the Device Selection window.
4. The PC will automatically recognize the MaxiVCI Mini.
5. Click **Update** to complete the update if one is available.

10 VCI Manager

This application pairs the tablet with the MaxiVCI Mini, checks the communication status and updates the VCI software and TPMS service firmware.

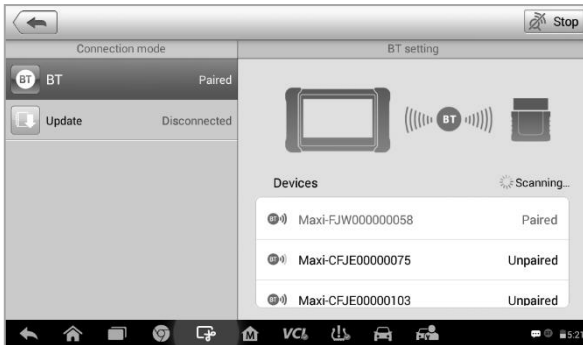

Figure 10-1 Sample VCI Manager Screen

1. Connection Mode – there are three connection modes available for selection. The connection state displays.
 - BT Paring – when paired to a wireless device, the connection state displays as Paired; otherwise it displays as Unpaired.
 - Update (for VCI software only) – when the MaxiTPMS tablet and the MaxiVCI Mini are connected by a USB cable, this function is used to update VCI software via Internet.
 - Programmer update - updates MaxiProgrammer 201 firmware via Internet.
2. BT Setting

The BT Setting screen displays the types and product serial numbers for all the devices available for pairing. Tap a device to start pairing. The BT status icon displayed to the left of the device name indicates the received signal strength.

BT Pairing

The MaxiVCI Mini needs to be connected to a vehicle, so that it is powered during the synchronization procedure. Ensure the tablet has sufficient battery life or is connected to an external power supply.

➤ To pair the MaxiVCI Mini with the Display Tablet

1. Power on the tablet.
2. Insert the 16-pin vehicle data connector of the MaxiVCI Mini to the vehicle data link connector (DLC).
3. Tap the **VCI Manager** application on the MaxiTPMS Job Menu of the tablet and select **BT** from the connection mode list.
4. Tap the **Scan** button at the top right corner to search for available pairing devices.
5. The device name may display as Maxi suffixed with a serial number. Select the appropriate device for pairing.
6. When paired successfully, the connection status displays the device name with the message **Paired**.
7. Once paired, the VCI button on the system Navigation bar at the bottom of the screen will display a green check and the Connection LED on the MaxiVCI Mini illuminates solid blue. This signifies that the tablet is connected to the MaxiVCI Mini, and is ready to perform vehicle diagnosis.
8. Tap the paired device again to unpair it.
9. Tap the **Home** button on the top left to return to the MaxiTPMS Job Menu.

🔗 NOTE

A MaxiVCI Mini can be paired to only one tablet at a time, and once it's paired, the device will not be discoverable to other devices.

Update

Please refer to [Update via Display Tablet](#) on page 103 for details.









11 Shop Manager



The **Shop Manager** application manages the workshop information including customer information records and test vehicle history records. There are three main functions available:

- Vehicle History
- Workshop Information
- Customer Manager

The operations of these functions of the Shop Manager application are controlled by the toolbar buttons, which are listed and described in the table below:

Table 11-1 Top Toolbar Buttons in Shop Manager

Button	Name	Description
	Back	Returns to the previous screen.
	Diagnostics	Tap this button to access vehicle Diagnostics menu.
	Enter Edit	Tap this button to display the editing toolbar and print or delete the selected file.
	Delete	Tap this button to delete the selected vehicle record.
	Search	Enter the vehicle name or test path to retrieve vehicle record.
	Cancel	Tap this button to cancel editing or file search.
	Edit	Tap this button to edit information for the displayed file.
	Add Account	Tap this button to create a new customer account file.

Button	Name	Description
	History Notes	Tap this button to open a not form. Video, image and text files may be attached.
	Vehicle History	Tap this button to display the Vehicle History with the corresponding test vehicle records.
	Done	Complete editing and save the file.

Vehicle History

This function stores test vehicle history records, including vehicle information and the retrieved DTCs from previous diagnostic sessions. All information is displayed in summarized details. Tap on a record to resume a diagnostic session on a “stored vehicle”.



Figure 11-1 Sample Vehicle History Screen

- **To activate a test session for the recorded vehicle**
 1. Tap the **Shop Manager** application on the MaxiTPMS Job Menu.
 2. Select **Vehicle History**.
 3. Tap the **Diagnostics** button at the bottom of the thumbnail of a vehicle record item.
 4. Or, tap the vehicle record thumbnail to view record.

5. A Historical Test record displays, check the recorded information of the test vehicle, and tap the Diagnostics button on the upper right corner.
6. The vehicle's Diagnostics screen displays a new diagnostic session, see [Diagnosis](#) on page 52 for detailed instructions on vehicle diagnostic operations.

Historical Test Record

The Historical Test record sheet is a detailed data form that includes general vehicle information such as vehicle year, make and model. The form also includes retrieved DTC from previous test and all information manually inputted by the technician.

Figure 11-2 Sample Historical Test Record Sheet

- **To edit the Historical Test record sheet**
1. Tap the **Shop Manager** application on the MaxiTPMS Job Menu.
 2. Select **Vehicle History**.
 3. Select the specific vehicle history record thumbnail from the main section. The Historical Test record sheet displays.
 4. Tap the **Edit** button to start editing.
 5. Tap on each item to input the corresponding information or add relevant files or images.



NOTE

The vehicle VIN number, or license and the customer information account are correlated by default.

6. Tap **Add to Customer** to supplement the Historical Test record sheet to an existing customer account, or add a new associated account with the test vehicle record. See [Customer Manager](#) on page 111 for more information.
7. Tap **Done** to save the updated record sheet, or tap **Cancel** to exit without saving.

Workshop Information

Use the Workshop Information form to edit, input and save the detailed workshop information, such as shop name, address, phone number and other remarks, which when printing vehicle diagnostic reports and other associated test file, will display as the header of the printed documents.

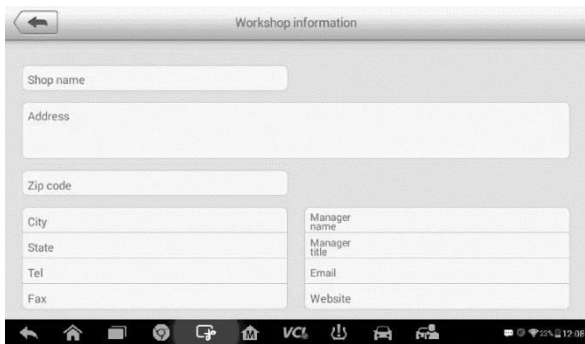

Figure 11-3 Sample Workshop Information Sheet

- **To edit the Workshop Information sheet**
1. Tap the **Shop Manager** application on the MaxiTPMS Job Menu.
 2. Select **Workshop Information**.
 3. Tap the **Edit** button on the top toolbar.
 4. Tap on each field to input the appropriate information.
 5. Tap **Done** to save the updated workshop information sheet, or tap **Cancel** to exit without saving.

Customer Manager

Use the Customer Manager function to create and edit customer accounts and correlate with the associated test vehicle history records.

➤ **To create a customer account**

1. Tap the **Shop Manager** application on the MaxiTPMS Job Menu.
2. Select **Customer Manager**.
3. Tap the **Add Account** button. An empty information form displays, tap each field to input the appropriate information.

🕒 **NOTE**

Required fields are noted.

4. Tap the **+** photo frame beside the Name chart to add a photo. A sub menu displays, select **Take Photo** to take a new photo for the account, or select **Choose Photo** to choose from an existing image.
5. If a customer adds or changes vehicles, tap **Add New Vehicle Information**, and input the vehicle information. Tap the **✕** button to cancel.
6. Tap **Done** to save the account, or tap **Cancel** to exit without saving.

➤ **To edit a customer account**

1. Tap the **Shop Manager** application on the MaxiTPMS Job Menu.
2. Select **Customer Manager**.
3. Select a customer account by tapping the corresponding name card. A Customer Information sheet displays.
4. Tap the **Edit** button on the top toolbar to start editing.
5. Tap on the input field that needs to be altered or supplemented, and enter updated information.
6. Tap **Done** to save the updated information, or tap **Cancel** to exit without saving.

➤ **To delete a customer account**

1. Tap the **Shop Manager** application on the MaxiTPMS Job Menu.
2. Select **Customer Manager** and select a customer account by tapping the corresponding name card. A Customer Information sheet displays.

3. Tap the **Edit** button on the top toolbar to start editing.
4. Tap the **Delete Customer Information** button. A confirmation message displays.
5. Tap **OK** to confirm the command, and the account is deleted. Tap **Cancel** to cancel the request.

History Notes

Use the History Notes function to add video records, text notes and photos for the associated customer account.

➤ To access History Notes







1. Tap the **Shop Manager** application on the MaxiTPMS Job Menu.
2. Select **Customer Manager** or **Vehicle History**.
3. Select a customer account by tapping the corresponding name card. A Customer Information sheet displays (if **Customer Manager** is selected). Or, select a vehicle history record item to open the Historical Test record sheet (if **Vehicle History** is selected).
4. Tap the **History Notes** button on the top bar. Now the History Notes screen displays.



Figure 11-4 Sample History Notes Screen

1. Functional Buttons – navigates and performs various actions.
2. Main Section – displays the note list on the left column and the detail information of the selected note displays on the right column.

Table 11-2 Function Buttons in History Notes

Button	Name	Description
	Back	Returns to the previous screen.
	Delete	Deletes the selected note.
	Search	Quickly locates the required note by entering the note title.
	Cancel	Cancels edit or file search.
	Edit	Tap this button to open an edit window to edit notes.
	Add Notes	Adds new note to History Notes.
	Save	Saves notes.

➤ **To add a note in History Notes**

1. Access History Notes.
2. Tap the **Add Notes** button. An edit window displays.
3. Tap on the Title bar to input a note title.
4. Tap on the blank space below to edit a text note or remark.
5. Select a function button on the top to add files in any form you choose.
6. Tap **Save** to save the note; tap **Discard** or **Cancel** to exit without saving.

12 Academy

Autel provides various tutorial articles and technical bulletins produced by top-notch technicians and product experts. Please view the materials that are saved on the tablet or view technical articles from our online forum by clicking the links displayed under this application.

13 Data Manager

The **Data Manager** application is used to store, print, and review the saved files. Most operations are controlled through the toolbar.

Selecting the Data Manager application opens the file system menu. Different file types are sorted separately under different options, there are five types of information files to be viewed or played back.



Figure 13-1 Sample Data Manager Main Screen

Operations

Data Manager Operations are based on toolbar controls. Details are explained in the following sections.

Image Files







The Image section contains all captured screenshot images.



Figure 13-2 Sample Image Screen

1. Toolbar Buttons – used to edit, print and delete the image files. See the following table for detailed information.
2. Main Section – displays the stored images.

Table 13-1 Toolbar Buttons in Image Screen

Button	Name	Description
	Back	Returns to the previous screen.
	Enter Edit	Tap this button to display the editing toolbar. Print, delete or view image information.
	Cancel	Tap this button to close the editing toolbar or cancel file search.
	Search	Quickly locates the image file by entering the vehicle name, test path, file name or file info.
	Info	Tap this button to display image details.
	Print	Tap this button to print the selected image.
	Delete	Tap this button to delete the selected image.

➤ **To edit image information**

1. Select **Data Manager** application on the MaxiTPMS Job Menu.
2. Select **Image** to access the image database.
3. Select an image to display in full screen.
4. Tap the screen once to display the editing toolbar.
5. Tap the **Info** button to display the image information.
6. Tap the **Edit** button on the top right corner of the window. The editing screen displays.
7. Edit the image information by entering the new file name, and file information.
8. Tap **Done** to save the information and exit, or tap **Cancel** to exit without saving.

➤ **To delete selected images**

1. Select **Data Manager** application on the MaxiTPMS Job Menu.
2. Select **Image** to access the image database.
3. Tap the **Enter Edit** button to display the editing toolbar.
4. Select the images that need to be deleted by tapping the thumbnail images, the selected thumbnail displays a check at the bottom right corner.
5. Tap the **Delete** button, and then tap **Delete Selected**. The selected images will be deleted.

➤ **To print selected images**

Please refer to [Printing Setting](#) on page 95 for details.

PDF Files

The PDF section stores and displays all saved data PDF files. Select a PDF from the database to display.

The standard Adobe Reader application is used for file viewing and editing, please refer to the associated Adobe Reader manual for detailed instructions.

Review Data

The Review Data section allows playback of the recorded data frames of live data streams.

On the Review Data main screen, select a record file to playback.

Name	Value	Unit
<input type="checkbox"/> Ignition State	High	
<input type="checkbox"/> Speed (EMS)	2	km/h
<input type="checkbox"/> Speed (ABS/ESC)	96	km/h
<input type="checkbox"/> Battery voltage A-D value	4.37	V
<input type="checkbox"/> Ignition voltage A-D value	0.77	V
<input type="checkbox"/> TREAD LED output state	Off	

Figure 13-3 Sample Data Playback Screen

1. Drop-down Toolbar – tap the button at the top center of the screen to open the Drop-down Toolbar.
2. Main Section – displays the recorded data frames.
3. Navigation Toolbar – controls data playback.

Use the Navigation Toolbar buttons to playback the record data from frame to frame.

Tap **Back** to exit data playback.

Apps Uninstall

Manage the firmware applications installed on the MaxiTPMS Diagnostics System. Select this to open a management screen, on which all the available vehicle diagnostic applications can be reviewed.

Tap on the vehicle manufacturer icon that you wish to delete. The selected icon will display a blue check at the upper right corner. Tap the **Delete** button on the top bar to delete the firmware from the system database.

Data Logging

Data Logging allows you to launch Support platform directly to view all records of all sent or unsent (saved) data logs on the diagnostic system. For more details, please refer to [Data Logging](#) on Page 133.

14 MaxiFix

The MaxiFix application launches the on-line troubleshooter database, which not only provides all common diagnostic trouble codes (DTCs) for most vehicles, but also serves as a forum allowing for technicians to network with other MaxiTPMS users, and gives users access to a vast database of repair and diagnostic tips along with proven tips.

The MaxiFix database keeps growing with daily troubleshooting resources and advisory reports from MaxiTPMS users from all over the world.

Information in the MaxiFix database is organized into a series of diagnostic tips that are designed to quickly lead to the root cause of a particular problem on the test vehicle.

Navigation

You need to register the device to your online account before launching the MaxiFix platform, see [Product Registration](#) on page 129 for details.



Figure 14-1 Sample MaxiFix Home Page

The MaxiFix screen layout consists of three main areas:

1. The Header – the tool bar across the top of the screen which allows you to select vehicles and perform searches.
2. The Main Screen – located at the center of the screen displaying content based on the vehicle attributes and keywords specified. The tabs on the main screen vary in accordance with the section chosen on the Navigation Menu, allowing you to switch between functions.
3. The Navigation Menu – the main menu at the bottom of the screen that provides access to different sections of MaxiFix.

The Header

The Header at the top of the screen features:

- A Select Vehicle button to open the vehicle identification window, and vehicle information bar, for example “2014 > Hyundai > Accord Coupe > L4-2.4L (K24W1)”.
- A search field to find relevant information by entering keywords, codes, or problems.

Select Vehicle Button

The “Select Vehicle” button on the Header allows you to specify the vehicle that you want to research on MaxiFix, by selecting each of the vehicle attributes from a sequence of option lists. This feature helps to filter out the searches that allow only the information that applies to the identified vehicle to display.

NOTE

All attributes must be specified to make a complete vehicle selection for the most efficient search.

➤ To select a vehicle

1. Click the “Select Vehicle” button on the Header.
2. Select the **year** of the vehicle from the list.
3. Select the **manufacturer** of the vehicle from the list.
4. Select the **model** of the vehicle from the list.
5. Select the **submodel** of the vehicle from the list.
6. Select the **engine** of the vehicle from the list.

After completing the vehicle selection procedure, the selected vehicle is shown on the Header.

Terminology

MaxiFix Tip

A MaxiFix Tip offers a detailed outline of an actual vehicle repair. Combined with proven results and vehicle specific data, this all-in-one information source provides quick and easy repair solutions.

On MaxiFix community you can find Tips or share your own Tip to help other community.

➤ **To search for a MaxiFix Tip**

1. Select a Vehicle:
 - a) Click **Select Vehicle** on the Header at the top of the page.
 - b) Select the **year** of the vehicle from the list.
 - c) Select the **manufacturer** of the vehicle from the list.
 - d) Select the **model** of the vehicle from the list.
 - e) Select the **submodel** of the vehicle from the list.
 - f) Select the **engine** of the vehicle from the list.

After completing the vehicle selection procedure, the chosen vehicle is shown on the Header.

2. Enter a Search Term.

MaxiFix has an exclusive one-stop lookup that helps you find all of MaxiFix resources with one click. Input a search term into the search bar on the Header to begin the search.

3. Proven Results.

The powerful MaxiFix database gives you proven results. The typical MaxiFix Tips combine actual workshop fixes and vehicle repair data that include:

- a) OBD II Fault Codes description and reference – helps in diagnostic assessment by making clear the nature of an automotive problem so that beginner and advanced technicians can make effective repairs.
- b) Real Fix Tips – provides repair tips from actual shop practices and

are presented in an easy-to-understand Complaint, Cause and Correction format.

If you are unable to find the information relating to your specific problem, you can pose a question to the MaxiFix community by clicking “Ask” on the Navigation Menu at the bottom of the screen.

Adopted!

The “Adopted!” icon displays at the top right side of a Tip page when at least one technician has “adopted” or recommended the tip. If a tip has helped you to solve a repair problem, you are encouraged to give an Adopted! count to the tip. Each member is allowed to click “Adopted!” The “Adopted!” count identifies the tips that are really helpful. As reference to other members, you can also post a comment about how the tip has helped you.

Operations

The Navigation Menu is at the bottom of the screen. Selecting the items on the Navigation Menu allows you to switch between the main sections on MaxiFix. These main sections include:

- Home – displays all questions and allows you to specify questions about one or multiple manufacturer vehicles.
- Search Fix – allows you to search for information from all available resources on MaxiFix, including: Open Questions, Tips, and Real Fixes, and displays search results.
- Ask – allows you to ask a question in the community.
- My MaxiFix – displays all your posts including Questions and Fixes in the community, and allows you to view your personal profile, select your vehicle preference, and share your tips.
- My Messages – displays a list of message notifications that are relevant to your activities in the Question section.
- Support – opens the FAQ page, or a message box for contacting Customer Service by email.

Home

Home is the first option on the Navigation Menu at the bottom of the screen. Tap to open your MaxiFix home page. There is a list of questions posted on the community. Scroll down the page to view more questions by tapping “View More”. Click on any question and you will be directed to the detailed page in the Ask section.

Click the “Filter” button on the main page of Home, and select the vehicle manufacturers that you are interested in. This filter can be canceled anytime by clicking the “Remove All Filters” button, and the default setting will be restored to display questions about all vehicle makes.

Search Fix Features

Search Fix, the second option on the Navigation Menu at the bottom of the screen, presents search results for the specified vehicle. Search results are listed in various categories:

- All – includes all search results, including related Questions, Tips, and Real Fixes to your search.
- Questions – presents a list of open Question discussed in the community that may be pertinent to your search.
- Tips – presents a list of Tips that directly correlate to your search criteria. Select a Tip from the list to open and review the complete Tip.
- Real Fixes – presents a list of Tips that have been collected from actual shop repair orders and are presented in an easy-to-understand Complaint, Cause, and Correction format.

Ask

Ask, the third option on the Navigation Menu at the bottom of the screen, allows you to ask a question about a particular vehicle repair issue in the community.

➤ To ask a MaxiFix Question

1. Click **Select Vehicle** on the Header to specify the vehicle you are asking about.
2. Click **Ask** on the Navigation Menu at the bottom of the screen to

open the Ask page.

3. On the **Ask** page find **Ask for Help** and complete the section to ask a question.

The Ask page has four sections:

- Subject – enters a brief subject for the question.
- My Question – asks a clear and concise question that you want to ask the community. Be sure to be descriptive and concise when asking your question.
- Problem Description – describes how the vehicle is behaving.
- Repair History – includes any previous diagnostic tests that you performed, including the results of the tests. Also list any parts that were replaced during previous diagnostic work.

Tap **Cancel** to cancel your question and return to the Ask page.

Tap **Submit** to post your question to the community.

Tap **Attach File** to include images or reference files with your question.

Select one answer from the responses and then close the question. For details, please refer to [My Messages](#) on page 127.

My MaxiFix

My MaxiFix, the fourth option on the Navigation Menu at the bottom of the screen, opens your personal MaxiFix page. To access the features on My MaxiFix page you can select from the following tabs:

- My Questions – opens a list with links to the opened questions that you have posted to the community.
- My Cases – opens a list with links to the closed questions and tips that you have contributed to the community.
- Marked Posts – opens a list with links to Tips and discussions that you are actively participating in.
- My Profile – allows you to view your Autel account information including: your Autel ID, personal information, MaxiFix score, phone number and register time, and add an avatar image.
- Vehicle Preference – used to set up a list of preferred vehicles. The

preferred list allows you to limit the choices that display on the “Select Vehicle” list to specific years and makes. Click “Set Year” or “Set Make” to set your preferred models. The preferred makes will also be displayed in the “Filter” options on the Home page.

- **Share a Tip** – allows you to share your personal repair experience with the community.

Click **My MaxiFix** on the Navigation Menu at the bottom of the screen, to display all questions and tips that you have contributed to the community.

Create a Tip

A “Tip” is a concise and complete description of the fix for a particular vehicle repair issue.

➤ **To create a new MaxiFix Tip**

1. Select **My MaxiFix** on the Navigation Menu.
2. Select **Select Vehicle** from the Header and enter the identifying attributes of the vehicle you are writing the Tip about.
3. On the My MaxiFix page find **Share a Tip**; click this link to open the **My Tips** page.
4. Enter the Tip subject in the **Subject** field.
5. Compose your Tip in the **Description** field. Include as much information as possible, while keeping the information concise. A Tip should provide accurate information that is reader-friendly.

Use the **Cancel** button at the bottom right of the page to cancel creating a tip and return to the My MaxiFix page. Or,

Use the **Submit** button at the bottom right of the page to add your tip to the community.

Use the **Attach File** button at the bottom left of the page to include images or other supporting data with your question.

View Profile Information

You can view or edit your personal profile by clicking on your account ID or “My Profile” in My MaxiFix section. View the profiles of other community members by clicking their portrait. Information included in your profile

determines how you are presented to the community, and what type of information will be sent to you from the community.

My Messages

My Messages, the fifth option on the Navigation Menu at the bottom of the screen, shows a list of message notification that are relevant to your activities in the Question section. A notification icon will appear on the top-right corner of “My Messages” if there is any new or unread message in the Question section. The number on the notification icon indicates the total number of the new and unread messages. The message notification will appear under the following two conditions:

1. A MaxiFix community member has replied to your question or answer.
2. A MaxiFix community member has “Adopted!” one of your answers.

Tap **My Messages**, select and open a message from the list. If your problem is solved, you should select one “Adopted Answer” and close the question. If your answer is marked as “Adopted!”, “Adopted! + 4” will be displayed permanently.

Tap **Clear** to delete all message notifications.

Select “Adopted Answers”

Members should select one Adopted Answer from responses on “My Messages” page before closing a question. Community members who provide the “Adopted Answer” are rewarded with scores for their contribution.

About Adopted Answer:

- Only one answer can be selected as “Adopted Answer”.
- Only the MaxiFix member who asked the question can rate the “Answer”.

Close a Question

When a repair question that you've posted to the community is resolved, you are encouraged to comment on the resolution as a way to share good information with the community. This will help the other MaxiFix members.

To close a question, you need to select the question's response message from the message list on “My Messages” page first, then tap “Adopted Answer”

and select "Close Question". Tap the "Cancel" button to cancel your submission and return to My Messages page. It is strongly recommended that you share your repair solutions before closing a question. Your question will be converted to a MaxiFix Community Tip after closing.

Score Rewarding System

1. A score of 4 is awarded if your answer is selected as the "Adopted Answer".
2. A score of 3 is awarded when you close a question.
3. A score of 2 is awarded if your closed question is marked as "Adopted!" by no less than 20 community members.
4. A score of 1 is awarded if your answer is selected as the "Adopted Answer" for a closed question that is marked as "Adopted!" by no less than 20 community members.
5. A score of 1 is awarded to each of the first three respondents.

Support

Support, the last option on the Navigation Menu at the bottom of the screen, opens a page that provides two ways to gain support from MaxiFix:

1. A message form to contact the MaxiFix administrator.
2. Frequently Asked Questions (FAQ) section that answers the community's most frequently asked questions.

If you wish to contact the administrator of this site please use the contact form. Select "Support" from the Navigation Menu to open the comment window. To allow the administrator to respond to your question or issue, the following information should be provided:

- Your name
- A contact email address
- A contact phone number

15 Support

This application launches the Support platform that synchronizes Autel's on-line service base station with the tablet. The device must be registered to receive support, download software updates and initiate the warranty on your device. The Support application is connected to Autel's service channel and on-line communities. This is the quickest way to connect with Autel's support staff. Here you can quickly submit complaints or send help requests for direct service and support.

Product Registration

Please register your tablet prior to first use. The tablet must be registered to access the Support platform and obtain update and other services from Autel.

➤ To register the diagnostic device

1. Visit the website: <http://pro.autel.com>.
2. If you already have an Autel account, Sign In with your account ID and password.
3. If you are a new member to Autel, click on the **Create Autel ID** button on the left side to create an ID.
4. Enter the required information in the input fields, and click the **Get Verification Code button** to get the verification code for email validation.
5. The online system will automatically send a verification code to the registered email address. Input the code in the Verification Code and fill in other input fields, read through Autel's Terms and Conditions and click on Agree, and then click **Create Autel ID** at the bottom. A product registration screen will display.
6. The device's serial number and password is located in the *About* section of the Settings application on the tablet.
7. Select your product model, enter the product serial number and password on the Product Registration screen, and click **Submit** to complete the registration procedure.

Support Screen Layout

The Support application interface is navigated by four buttons on the top navigation bar. The operation of each is described below, from left to right:

- Home Button – returns to the MaxiTPMS Job Menu.
- Back – returns to the previous screen.
- Forward – moves forward one screen at a time.
- Refresh – reloads and updates the screen.



Figure 15-1 Sample Support Application Screen

The main section of the Support screen is divided into two sections. The narrow column on the left is the main menu; selecting one subject from the main menu displays the corresponding functional interface on the right.

My Account

The My Account screen displays the comprehensive information of the user and the product, synchronized with the on-line registered account, including User Info, Device Info, Update Info and Service Info.

Personal Info

The User Info and Device Info are both included under the Personal Info section.

- User Info – displays Autel account information, such as your Autel ID,

Name, Address and other contact information.

- Device Info – displays the registered product information, including the Serial Number, Registration Date, Expire Date, and Warranty Period.

Update Info

The Update Info section displays a detailed record list of the product's software update history, including the product serial number, software version or name, and the update time.

Service Info

The Service Info section displays a detailed record list of the device's repair history, including documenting device faults and repair actions including software installation and component changes. This record is updated to the associated online device and user accounts and synchronized to the Service Info section.

User Complaint

Access the User Complaint screen to issue a new complaint case and/or view historical complaint records.

Screen Layout

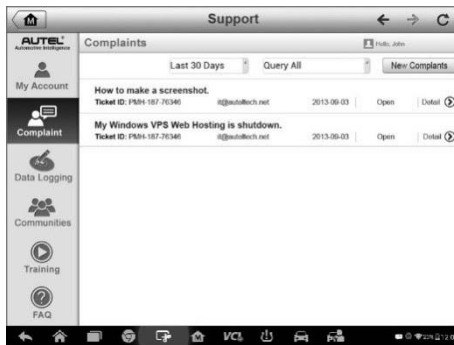

Figure 15-2 Sample Complaint Screen

The User Complaint screen consists of two parts.

1. Option Bar

- Period Filter – displays only the complaint records within the defined period on the list.
- Status Filter – displays the corresponding complaint records according to the selected case status.
- New Complaint Button – starts a new complaint case.

2. Complaint List

The complaint list normally displays all the complaint records of all time and all status by default. The summary information for each complaint item includes the Subject Name, Ticket ID, User's Account ID, Date, and the Case Status.

There are four case status types:

- Open – indicates the complaint case has been started but not processed yet.
- Suspended – indicates the complaint case is being processed.
- Waiting Customer Reply – indicates the complaint has been replied to by the service personnel, and requires feedback from the customer.
- Closed – indicates the complaint case has been processed, solved and ended.

To view the detailed complaint session, tap the > button on the right side of the case item.

➤ To establish a new complaint session

1. Register the product online.
2. Tap the **Support** application on the MaxiTPMS Job Menu. The device information is automatically synchronized with the online account.
3. Tap **Complaint** on the Main Menu.
4. Tap the **New Complaint** button at the upper right corner. A selection menu with a category of service channels displays.
5. Select your target service channel and click **Next** to continue. A standard complaint form displays. Enter pertinent vehicle information and device information. Images or PDF files may be

attached with complaints.

6. Enter the appropriate information in each input field. To ensure that the issue is resolved as quickly as possible, fill in the complaint form with as much as detail as possible.
7. Depending on the urgency of the case, select the required processing time.
8. Tap **Submit** to send the completed form to Autel's online service center, or tap **Reset** to refill it. The submitted complaints will be carefully read and handled by the service personnel, and the response speed may depend on the processing time requested.

➤ **To make a reply in a complaint session**

1. Register the product online.
2. Tap the **Support** application on the MaxiTPMS Job Menu. The device information is automatically synchronized with the online account.
3. Tap **Complaint** on the Main Menu.
4. Select an existing complaint case item on the record list by tapping the > button on its right side. The screen displays the complaint session details.
5. To reply, tap the **Post Reply** button on the upper right side after viewing. An edit screen displays.
6. Input the content in the input field, and if necessary, upload an attachment.
7. Tap **Submit** to post the reply.
8. Tap the **States** selection drop-down menu to reset a case state.
9. Tap the **Update** button to update case status.

Data Logging

The Data Logging section records all sent or unsent (saved) data logs on the diagnostic system. Through the Support platform, personnel receive and process the submitted data log session and then, within 48 hours, send back the corresponding Data Logging session. A resolution is sent within 48 hours. This support method gives the customer direct access to software staff.



Figure 15-3 Sample Data Log Screen

➤ **To reply in a Data Logging session**

1. Tap on the **Sent** tag to view a list of submitted data logs.
2. Select a specific item to track progress of data log review.
3. Tap **Send** to send your message to the technical center.

Communities

The Communities section synchronizes with the Technical Forums on Autel's official websites www.autel.com and www.maxitpms.com to discuss technical topics or share information, ask for technical advice or offer technical support to other members of Autel's online support communities.

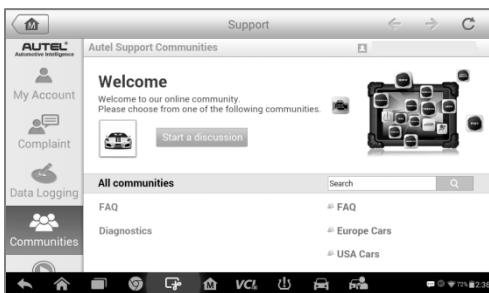

Figure 15-4 Sample Communities Home Screen

➤ **To start a discussion**

1. Tap **Start a discussion** on the Communities Home screen. A list of the major forums displays.
2. Select the subject that interests you. For example, if you want to ask a question about the MaxiTPMS tablet, tap **MaxiTPMS** to start a discussion.
3. Enter the topic and the discussion content in the appropriate input field.
4. Select a category or edit tags for the discussed post. This will help other members with similar interest to find your post.
5. Tap **OK** to submit the post.

➤ **To join and reply to a discussion post**

1. Select a forum group of interest, either by the product or the features. A list of the latest posts displays.
2. Select a specific category on the Categories menu to better pinpoint the topics you are most interested with.
3. To view a discussion, tap the ➤ button on the right of the topic. The posts displays.
4. Browse through all the posts by scrolling the screen up and down. Tap **Go to original post** to return to the first post.
5. Tap **Reply** to reply a specific post, or tap **Reply to original post** to join and continue the discussion.
6. Enter your comment in the input field, and tap **OK** to submit your post.

User Profile

Tap the profile photo on the Communities screen to open the User Profile section to check member status, add an profile photo and to review your posts in the communities.

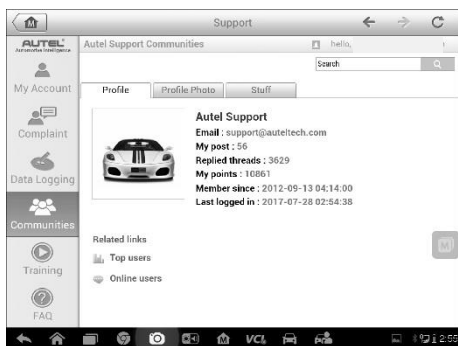

Figure 15-5 Sample User Profile Screen

- **Profile** – displays the user information and member status. The **Related links** allow you to check the Top Users (ranked according to their points and levels) in the communities, as well as to find other online users.
- **Profile Photo** – allows you to select an image to set as your profile photo to be displayed in the communities.
- **Stuff** – displays all the discussions you've posted at various forums in a list.

Training Channels

The Training section provides quick links to Autel's online video accounts. Select a video channel to see all Autel's available video tutorials. The videos provide product usage and vehicle diagnostics practices.

FAQ Database

The FAQ section provides comprehensive references for various frequently asked questions and answers about the use of Autel's online account, and shopping and payment procedures.

- **Account** – displays questions and answers about the use of Autel's online user account.
- **Shopping & Payment** – displays questions and answers about online product purchase and payment methods or procedures.

16 Remote Desk

The **Remote Desk** application launches the TeamViewer Quick Support program, a simple, fast and secure remote control interface. Use this application to receive ad-hoc remote support from Autel's support technicians by allowing them to control your MaxiTPMS tablet on their PC via the TeamViewer software.

Operations

If you think of a TeamViewer connection as a phone call, the TeamViewer ID would be the phone number by which TeamViewer Clients can be reached individually. Computers and mobile devices that run TeamViewer are identified by a unique global ID. This unique ID is generated the first time the Remote Desk application is used and does not change.

The tablet must be connected to the Internet prior to launching TeamViewer.



Figure 16-1 Sample Remote Desk Screen

- **To receive remote support from a partner**
 1. Power on the Display Tablet.
 2. Tap the **Remote Desk** application on the MaxiTPMS Job Menu. The TeamViewer interface displays and the device ID is generated and shown.

3. Provide your ID to the partner, and wait for him/her to send you a remote control request.
4. Tap **Allow** to accept, or tap **Deny** to reject.

For additional information, visit TeamViewer's website.

17 Quick Link

The Quick Link application provides access to Autel's official websites and to other popular automotive service websites. These sites are an invaluable resource of automotive information and repair data and include forums, video training and expert consultation.

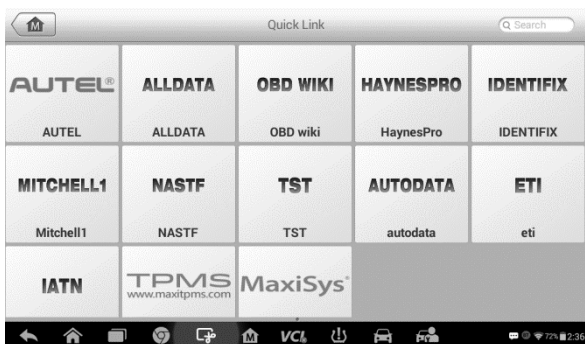

Figure 17-1 Sample Quick Link Screen

➤ **To open a quick link**

1. Tap the **Quick Link** application on the MaxiTPMS Job Menu. The Quick Link application screen displays.
2. Select a website thumbnail on the main section. The Chrome browser is launched and the selected website is opened.

18 Function Viewer

The Function Viewer allows you to search for supported functions. There are two ways to search: by vehicle or by function.

➤ To search by the vehicle

1. Tap the **Function Viewer** application on the MaxiTPMS Job Menu. The Function Viewer application screen displays.
2. Tap the tool name on the top left to drop down the tool list, tap the one you want to search.

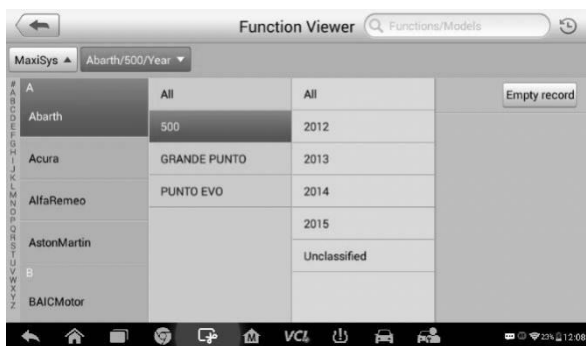

Figure 18-1 Sample Function Viewer Screen 1

3. Tap the vehicle brand, model, and year you want to search.
4. All the functions support by the selected tool for the selected vehicle displays within three column, function, sub function and version.

Function	Sub function	Version
Specil Function	Audio System Test	Above Fiat_V5.00
Specil Function	Bleed Hydraulic Circuit	Above Fiat_V5.00
Specil Function	Brake Switch Learn	Above Fiat_V5.00
Specil Function	CTM Proxi Configuration	Above Fiat_V5.00
Specil Function	Check PCM Odometer	Above Fiat_V5.00
Specil Function	Check PCM VIN	Above Fiat_V5.00

Figure 18-2 Sample Function Viewer Screen 2

➤ **To search by the functions**

1. Tap the **Function Viewer** application on the MaxiTPMS Job Menu. The Function Viewer application screen displays.
2. Tap the tool name on the top left to drop down the tool list, tap the one you want to search.
3. Type in the function you want to search to the top right search column. All the vehicles with this function will be listed with eight columns, the Brand, Model, Year, System, Sub system, Function, Sub function, and Version.

NOTE

Fuzzy search is supported, type in part of the name of the function you want to search for.

Brand	Model	Year	System	Sub system	Function	Sub function	Version
Buick	Others	(6) 2006	Powertrain	/	Special Function	Reset ECM	Above GM_V9.50
Buick	Others	(8) 2008	Engine control module	/	Special Function	Reset ECM	Above GM_V9.50
Chevrolet	Aveo	(4) 2004	Powertrain	/	Special Function	Reset ECM	Above GM_V9.50
Chevrolet	Aveo	(5) 2005	Powertrain	/	Special Function	Reset ECM	Above GM_V9.50
Chevrolet	Aveo	(6) 2006	Powertrain	/	Special Function	Reset ECM	Above GM_V9.50
Chevrolet	Aveo	(7) 2007	Engine control module	/	Special Function	Reset ECM	Above GM_V9.50

Figure 18-3 Sample Function Viewer Screen 3

19 Maintenance and Service

Maintenance Instructions

The following shows how to maintain your devices, together with precautions to take.

- Use a soft cloth and alcohol or a mild window cleaner to clean the tablet's touchscreen.
- Do not use any abrasive cleansers, detergent, or automotive chemicals on the tablet.
- Only use the device in dry conditions within normal operating temperatures.
- Dry your hands before using the tablet. The touchscreen may not work if the touchscreen is moist, or if you tap the touchscreen with wet hands.
- Do not store the devices in humid, dusty or dirty areas.
- Before and after use, check the housing, wiring, and connectors for dirt and damage.
- At the end of each work day, wipe the device housing, wiring, and connectors clean with a damp cloth.
- Do not attempt to disassemble your tablet or VCI unit.
- Take care not to drop the device or allow anything heavy to drop on the device.
- Use only authorized battery chargers and accessories. Any malfunction or damage caused by the use of unauthorized battery charger and accessories will void the limited product warranty.
- Ensure that the battery charger does not come in contact with conductive objects.
- Do not operate the tablet next to anything such as a microwave oven, cordless phone and some medical or scientific instruments that might interfere with or prevent signal interference.

Troubleshooting Checklist

- A. When the tablet does not work properly:
- Make sure the tablet has been registered online.
 - Make sure the system software and diagnostic application software are properly updated.
 - Make sure the tablet is connected to the Internet.
 - Check all cables, connections, and indicators to see if the signal is being received.
- B. When battery life is shorter than usual:
- This may happen when you are in an area with low signal strength.
 - Turn off your device when not in use.
- C. When unable to power on the tablet:
- Make sure the tablet is connected to a power source or the battery is charged.
- D. When unable to charge the tablet:
- Your charger maybe out of order. Contact your nearest dealer.
 - You may be attempting to use the device in an overly hot/cold temperature. Use the tablet in an environment within normal operating temperatures.
 - Your device may have not been properly connected to the charger. Check the connector.



NOTE

If your problems persist, please contact Autel's technical support or your local distributor.

About Battery Usage

Your tablet is powered by a built-in Lithium-ion Polymer battery. The Lithium-ion Polymer battery can recharge while some charge remains without reducing your tablet's autonomy due to the "battery memory effect" inherent in this type of battery technology.



DANGER

1. The built-in Lithium-ion Polymer battery is factory replaceable only;

incorrect replacement or tampering with the battery pack may cause an explosion.

2. Do not use a damaged battery charger.

- Do not disassemble or open crush, bend or deform, puncture or shred.
- Do not modify or remanufacture, attempt to insert foreign objects into the battery, expose to fire, explosion or other hazard.
- Make sure to only use the supplied charger and USB cables. Using an unapproved charger or unapproved USB cable might not working correctly or might damage the tablet or VCI.
- Only use the supplied charging device that has been qualified for use with the device. Use of an unqualified battery or charger may present a risk of fire, explosion, leakage or other hazard.
- Avoid dropping the tablet. If the tablet is dropped, especially on a hard surface, and the user suspects damage, take it to a service center for inspection.
- Working closer to the WiFi router improves the working battery life of the tablet as less battery power is consumed to make connection.
- The battery recharging time varies depending on the remaining battery capacity.
- Battery life inevitably shortens over time.
- Since overcharging may shorten battery life, unplug tablet and charger from power outlet when tool is sufficiently charged.
- Leaving the tablet in hot or cold places, especially inside a vehicle in summer or winter, may reduce the battery's capacity and longevity. Always keep the battery within normal temperatures.

Service Procedures

This section introduces information for technical support, repair service, and application for replacement or optional parts.

Technical Support

If you have any question or problem about the operation of the product, please contact us (see the following contact info) or your local distributor.

AUTEL NORTH AMERICA

- **Phone:** 1-855-AUTEL-US(288-3587) Monday-Friday 9am-6pm EST
- **Website:** www.autel.com
- **Email:** sales@autel.com; ussupport@autel.com
- **Address:** 175 Central Avenue, Suite 200, Farmingdale, New York, USA 11735

AUTEL EUROPE

- **Phone:** 0049 (0) 6103-2000520
- **Website:** www.autel.eu
- **Email:** sales.eu@autel.com; support.eu@autel.com
- **Address:** Adalperstraße 82, 85737 Ismaning, Germany

AUTEL CHINA HQ

- **Phone:** 0086-755-2267-2493
- **Website:** www.autel.com
- **Email:** sales@auteltech.net; support@autel.com
- **Address:** 7-8th, 10th Floor, Building B1, Zhiyuan, Xueyuan Road, Xili, Nanshan, Shenzhen, 518055, China

AUTEL LATIN AMERICA

- **Website:** www.autel.com
- **Email:** sales.latin@autel.com; latsupport02@autel.com
- **Address:** Avenida Americas 1905, 6B, Colonia Aldrete, Guadalajara, Jalisco, Mexico

AUTEL APAC

- **Phone:** +045 5948465
- **Website:** www.autel.com/jp/
- **Email:** sales.jp@autel.com; support.jp@autel.com
- **Address:** 719, Nissou Building, 3-7-18, Shinyokohama, Kouhoku, Yokohama, Kanagawa, Japan 222-0033

AUTEL IMEA DMCC

- **Phone:** +971 585002709

- **Website:** www.autel.com
- **Email:** sales.imea@autel.com; imea-support@autel.com
- **Address:** Office 1006-1010, Cluster C, Fortune Tower, Jumeirah Lakes Tower (JLT), Dubai, U.A.E

Repair Service

If it becomes necessary to return your device for repair, please contact us first and then download the repair service form from www.autel.com and www.maxitpms.com, and fill it in. The following information must be included:

- Contact name
- Return address
- Telephone number
- Product name
- Complete description of the problem
- Proof-of-purchase for warranty repairs
- Preferred method of payment for non-warranty repairs



NOTE

For non-warranty repairs, payment can be made with Visa, Master Card, or with approved credit terms.

Send the device to your local agent, or to the below address:

8th Floor, Building B1, Zhiyuan, Xueyuan Road, Xili, Nanshan, Shenzhen, 518055, China

Other Services

You can purchase the optional accessories directly from Autel's authorized tool suppliers, and/or your local distributor or agent.

Your purchase order should include the following information:

- Contact information
- Product or part name
- Item description

- Purchase quantity

20 Compliance Information

FCC Compliance

FCC ID: WQ8MX808-TPMS

This device complies with Part 15 of the FCC rules and Industry Canada's license-exempt RSSs. Operation is subject to the following two conditions:

1. This device may not cause harmful interference.
2. This device must accept any interference received, including interference that may cause undesired operation.

Cet appareil est conforme aux CNR exempts de licence d'Industrie Canada. Son fonctionnement est soumis aux deux conditions suivantes:

1. Ce dispositif ne peut causer des interférences; et
2. Ce dispositif doit accepter toute interférence, y compris les interférences qui peuvent causer un mauvais fonctionnement de l'appareil.

WARNING

Changes or modifications not expressly approved by the party responsible for compliance could void the user's authority to operate the equipment.

NOTE

This equipment has been tested and found to comply with the limits for a Class B digital device, pursuant to Part 15 of the FCC Rules. These limits are designed to provide reasonable protection against harmful interference in a residential installation.

This equipment generates uses and can radiate radio frequency energy and, if not installed and used in accordance with the instructions, may cause harmful interference to radio communications. However, there is no guarantee that interference will not occur in a particular installation. If this equipment does cause harmful interference to radio or television reception, which can be determined by turning the equipment off and on, the user is encouraged to try to correct the interference by one or more of the following measures:

- Reorient or relocate the receiving antenna.

- Increase the separation between the equipment and receiver.
- Connect the equipment into an outlet on a circuit different from that to which the receiver is connected.
- Consult the dealer or an experienced radio/TV technician for help.

Changes or modifications not expressly approved by the party responsible for compliance could void the user's authority to operate the equipment.

SAR

The radiated output power of this device is below the FCC radio frequency exposure limits. Nevertheless, the device should be used in such a manner that the potential for human contact is minimized during normal operation.

The exposure standard for wireless devices employs a unit of measurement known as the Specific Absorption Rate, or SAR. The SAR limit set by the FCC is 1.6 W/Kg. Tests for SAR are conducted using standard operating positions accepted by the FCC with the device transmitting at its highest certified power level in all tested frequency bands.

Although the SAR is determined at the highest certified power level, the actual SAR level of the device while operating can be well below the maximum value. This is because the device is designed to operate at multiple power levels so as to use only the power required to reach the network. To avoid the possibility of exceeding the FCC radio frequency exposure limits, human proximity to antenna should be minimized.

RF WARNING STATEMENT

The device has been evaluated to meet general RF exposure requirement. The device can be used in portable exposure condition without restriction.

RoHS COMPLIANCE

This device is declared to be in compliance with the European RoHS Directive 2011/65/EU.

CE COMPLIANCE

This product is declared to conform to the essential requirements of the following Directives and carries the CE mark accordingly:

EMC Directive 2014/30/EU
R&TTE Directive 1999/5/EC
Low Voltage Directive 2014/35/EU

21 Warranty

Limited One Year Warranty

Autel Intelligent Technology Corp., Ltd. (the Company) warrants to the original retail purchaser of this MaxiTPMS Diagnostic Device that should this product or any part thereof during normal usage and under normal conditions be proven defective in material or workmanship that results in product failure within one year period from the date of purchase, such defect(s) will be repaired, or replaced (with new or rebuilt parts) with Proof of Purchase, at the Company's option, without charge for parts or labor directly related to the defect(s).

The Company shall not be liable for any incidental or consequential damages arising from the use, misuse, or mounting of the device. Some states do not allow limitation on how long an implied warranty lasts, so the above limitations may not apply to you.

This warranty does not apply to:

- 1) Products subjected to abnormal use or conditions, accident, mishandling, neglect, unauthorized alteration, misuse, improper installation or repair or improper storage;
- 2) Products whose mechanical serial number or electronic serial number has been removed, altered or defaced;
- 3) Damage from exposure to excessive temperatures or extreme environmental conditions;
- 4) Damage resulting from connection to, or use of any accessory or other product not approved or authorized by the Company;
- 5) Defects in appearance, cosmetic, decorative or structural items such as framing and non-operative parts.
- 6) Products damaged from external causes such as fire, dirt, sand, battery leakage, blown fuse, theft or improper usage of any electrical source.

**IMPORTANT**

All contents of the product may be deleted during the process of repair. You should create a back-up copy of any contents of your product before delivering the product for warranty service.
