

Part Number: TPR-301 / TPR-810



Kit Contents

Item #	Quantity Req'd.	Description
1	2	Fog Lamps
2	2	Bezels
3	1	Switch Assembly
4	1	Fog Light Operation guide
5	1	Harness bag

Hardware Bag Contents

Item #	Quantity Req'd.	Description
1	1	Wire harness
2	1	Switch harness
3	2	Relays
4	25	8" Wire ties
5	4	Phillip head screws
6	2	Red T-Taps
7	2	LED Connectors (for TPR-810)

Conflicts

-

General Applicability





Models:

Recommended Tools

Safety Tools	
Safety Glasses	
Electrical Tape	
Installation Tools	
10mm Wrench	
Phillips Screw Driver	
Pliers	
Side Cutters	
Special Chemicals	
3M Silicon Sealant	

Mandatory

Legend

	STOP: Damage to the vehicle may occur. Do not proceed until process has been complied with.
	OPERATOR SAFETY: Use caution to avoid risk of injury
	CRITICAL PROCESS: Proceed with caution to ensure a quality installation. These points will be audited on a completed vehicle installation
	TOOLS & EQUIPMENT: This calls out the specific tools and equipment required for this process
	REVISION MARK: This mark highlights a change in installation with respect to previous issue.

SPECIAL NOTE:

After **Auer Automotive Safety** mandated preparatory steps have been taken, the installation sequence is the suggested method for completing the accessory installation. In some instances the suggested sequence is written for one associate to install and in others the sequence is given as part of a team accessory installation. Unless otherwise stated in the document, the associates may perform the installation steps in any order to make the installation as efficient as possible while maintaining consistent quality. Also some items listed to be removed may not need to be removed if caution is taken to not damage vehicle.

Care must be taken when installing this accessory to ensure damage does not occur to the vehicle. The installation of this accessory should follow approved guidelines to ensure quality installation.

Preparation



Remove negative battery cable

1. Remove left and right splash shields from the front of the car. There are 18 x10mm bolts and 5 plastic push pins (see picture 1 and 2)



Picture 1



Picture 2

2. From inside the bumper, on the driver side of the vehicle, disconnect the wire harness and the 10mm bolt that are attached to the plastic fog lamp cover (see picture 3)

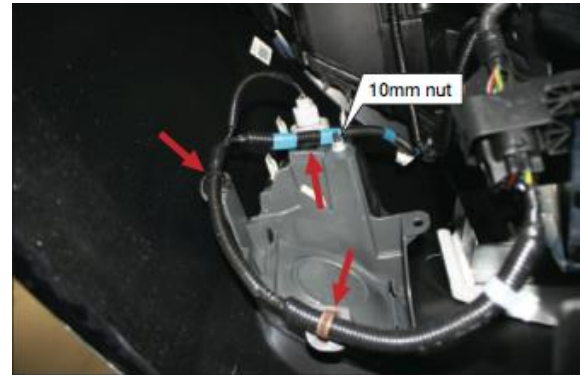

Picture 3

3. Push tabs away from the center of the fog lamp cover (picture 4)



Picture 4

4. From outside the bumper, push cover towards vehicle (picture 5)



Picture 5

5. Repeat steps 2 to 4 for the passenger side of the vehicle
6. Mount fog lights into bezel by sliding fog light tabs into slots and secure other side with supplied screw (see picture 6)

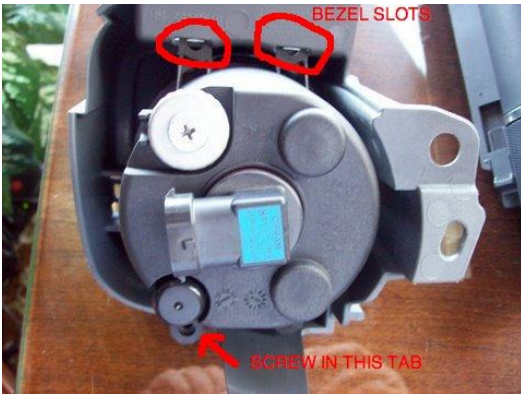

Picture 6

7. Install both fog light bezels
8. Install fog lamps into vehicle, by securing the 10mm bolt, reattach wire harness, and snap into place (picture 7)



Picture 7

9. Locate the ECU mounting bracket on the top left corner of the fuse block, right of the brake fluid reservoir (picture 8)



Picture 8

10. Attach the ring terminal with 2 black wires to the 10mm bolt off the ECU bracket (see picture 9)



Picture 9

11. In the hood area, locate the red 12v wire from fog light harness to inside the fuse block. Follow the path of the big white wire. 12v red wire will be connected at the end of the installation (picture 10)



Picture 10

12. Wire tie relay and fuse holder to harness (picture 11)



Picture 11

- 13. Route wire along factory harness and secure with wire ties (picture 12)



Picture 12

- 14. Locate the large vehicle harness grommet on the left side. If accessible, cut the auxiliary wiring access nipple off the grommet or cut 1/4" slit in grommet and push the orange/black and green/black wires through firewall. Note: Extra caution should be taken not to damage the connectors. Seal with 3M Silicone sealant (picture 13)



Picture 13

- 15. Route right fog light wire harness along top of engine compartment and secure with wire ties as detailed below (picture 14)

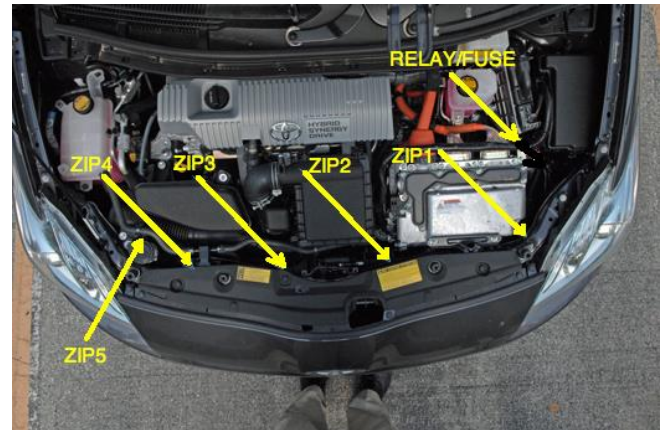

Picture 14

- 16. Zip tie 1: at the driver side of the radiator housing (picture 14A)

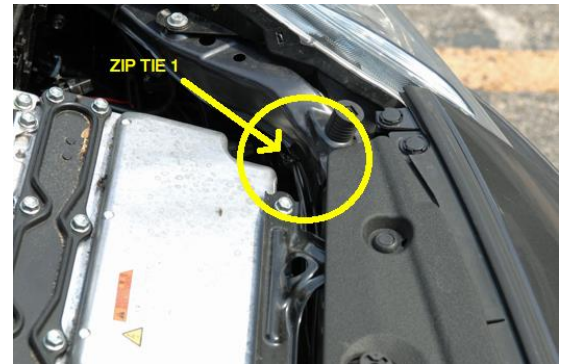

Picture 14A

- 17. Zip tie 2: secure wire harness to existing wire harness, about 1/3 to the left of radiator housing (picture 14B)

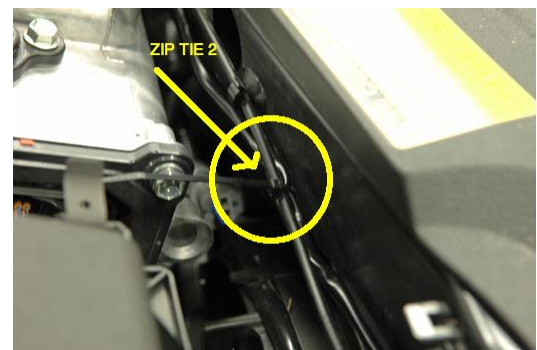

Picture 14B

18. Zip tie 3: secure wire harness to existing wire harness, about 2/3 to the left of radiator housing (picture 14C)

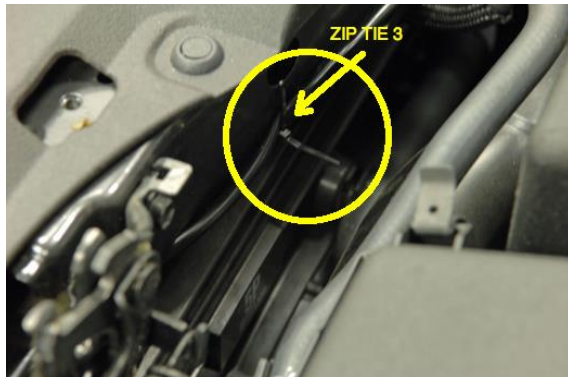

Picture 14C

19. Zip tie 4: Secure wire harness at the passenger side of radiator housing (picture 14D)

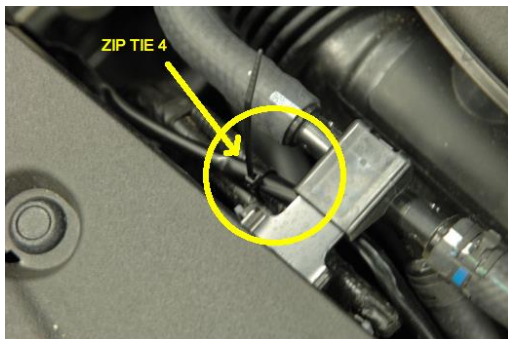

Picture 14D

20. Zip tie 5: secure to wire harness under the washer filler cap (picture 14E)

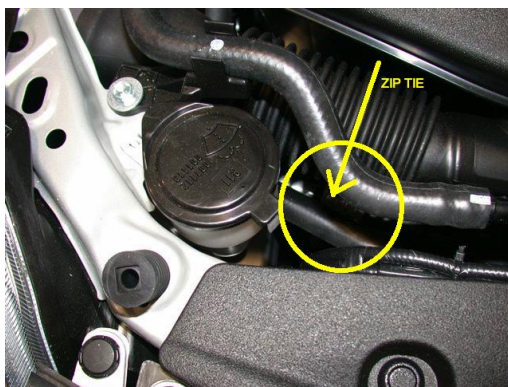

Picture 14E

21. Route right fog light harness down to right side fog light and plug connector into fog light

22. Route left side of wire harness down to left fog light and plug connector into fog light
23. Reattach the lower splash shields

Vehicle disassembly

24. Remove the 16mm plastic bolt from the side-kick panel (picture 15) and pull panel away.



Picture15

25. Remove screw from the bottom left dash panel (picture 16)



Picture 16

26. Disconnect the hood release cable from latch, by pulling down the black cable and releasing it from its location (picture 17)



Picture 17

27. Pull the left top side of the panel away from dashboard and unplug connectors. Extra caution should be taking not to pull to hard and damage connectors (picture 18)



Picture 18

28. Remove 2 screws and push back on tabs to release lower panel (picture 19)



Picture 19

29. Unplug wire harness and remove panel by pulling it towards the seat (picture 20)



Picture 20

30. Remove plastic cap from switch knockout of dash (picture 25)



Picture 25

31. Install switch in empty knockout of dash (picture 26)



Picture 26

32. From inside the cabin, locate the wires that were pushed through in step 14 and plug them to the switch wire harness. It will be the grommet above the gas pedal (picture 27)



Picture 27

33. If required, use a scissor to cut back the black sleeve over the orange/black and green/black wires to route wires as needed

- 34. T-tap orange/black wire from fog light harness to connector 2C pin 32, green wire. Pin 32 is on the left side of the connector 7th pin up from bottom of the connector. Connector 2C located left of the steering column above big white wire (picture 28, 29 and 29A).
- 35. T-Tap green/black wire from fog light harness to connector 2C pin 22, yellow wire (picture 28, 29 and 29A).

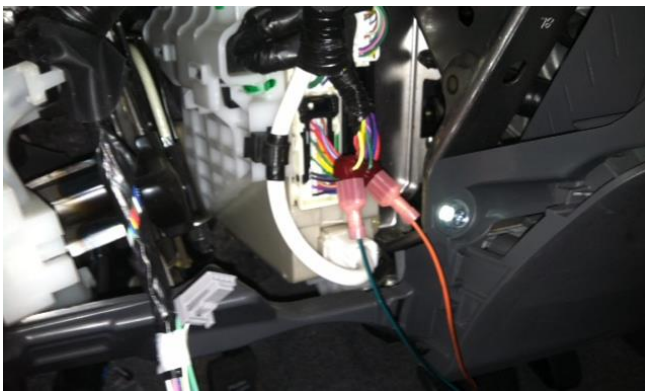

Picture 28

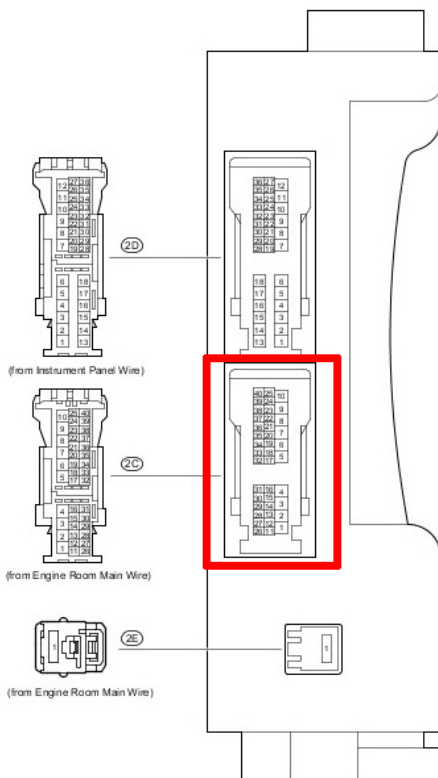

Picture 29

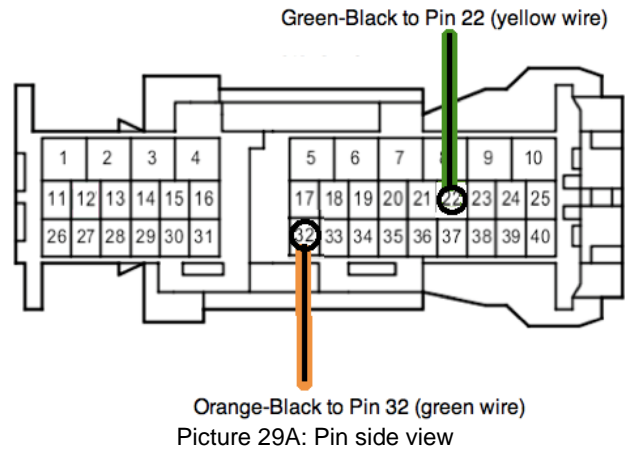

- 36. Install switch harness into switch (pic. 30)

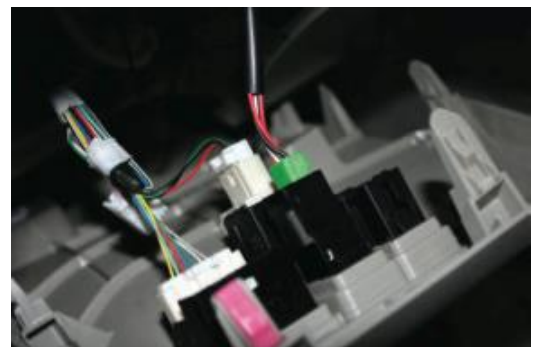

Picture 30

- 37. Secure fog light wire harness and relay with wire ties (picture 31)

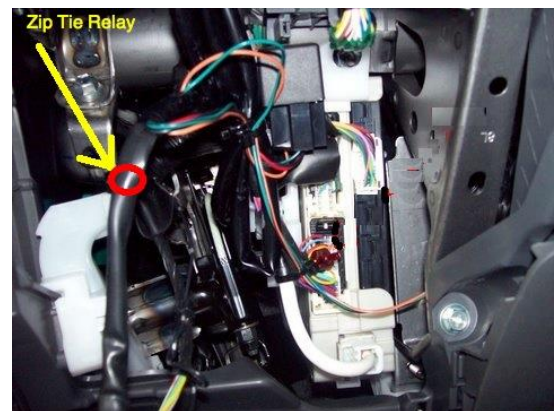

Picture 31

- 38. Reinstall all removed panels
- 39. Attach fog light 12v red wire to open spade inside the fuse block. Open spade is located right above white wire (picture 10)
- 40. Reconnect negative battery terminal and torque to: 36 in-lb

Check System for Operation

1. Reconnect battery negative terminal
2. Turn on headlamp low beams, then press fog light switch to "ON" position. Fog lights should be working. Fog lights will only work when the low beam headlamps are "ON". Fog lights will NOT work when the high beam headlamps are "ON"

Fog Light Aiming

Traditional fog lights are usually mounted in the front bumper about 10-24 inches from the ground. There are two important issues to address when installing fog lights: the first is to minimize the amount of return glare into the drivers eyes, and the other is to minimize the glare into oncoming eyes. Both of these issues must be accomplished while putting as much light as possible on the road.

These fog weather light aiming instructions are suggestions taken from common practice and the S.A.E. standard J583. Some modifications to these instructions may be necessary to minimize glare.

Visual aim is made with the top of the beam 4 inches below the lamp center at 25 feet with the lamp facing straight forward (see picture 39)

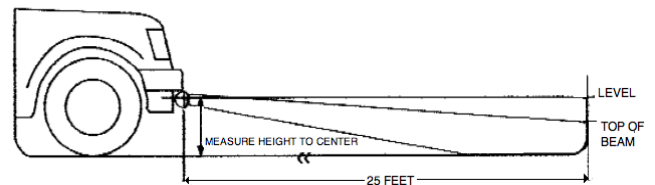

Picture 39

Checklist – these points MUST be checked to ensure quality installation

Check

Accessory Functions Checks

- Fog Lights function
- All Panels snapped into place.....
- Fog Lights.....
- Battery Terminal.....

Vehicle Function checks

- Check functions all switch functions

Look For:

Loose panels and switches

Visually confirm lights are straight forward

Re-torque negative battery terminal to 36 in-lb

Place fog light operation guide inside glove box.