

**Part Number: TCA-312 / TCA-812**



**Kit Contents**

Item #	Quantity Reqd.	Description
1	2	Light Housings
2	2	Fog Light Bezels
3	1	Switch Assembly
4	1	Fog Light Operation Guide
5	1	Harness Bag

**Hardware Bag Contents**

Item #	Quantity Reqd.	Description
1	1	Wire harness
2	1	Switch harness
3	2	Relays
4	25	Wire ties
5	4	Phillip head screws
6	2	Black T-Taps
7	2	LED Connectors (for TCA-812)

**Conflicts**

- SE models
-------------

**General Applicability**

Models:
---------

**Recommended Tools**

<b>Safety Tools</b>	
Safety Glasses	
Electrical Tape	
<b>Installation Tools</b>	
10mm Wrench	
Phillips Screw Driver	
Pliers	
Side Cutters	
<b>Special Chemicals</b>	
3M Silicon Sealant	

Mandatory

Legend

	<b>STOP:</b> Damage to the vehicle may occur. Do not proceed until process has been complied with.
	<b>OPERATOR SAFETY:</b> Use caution to avoid risk of injury
	<b>CRITICAL PROCESS:</b> Proceed with caution to ensure a quality installation.
	<b>TOOLS &amp; EQUIPMENT:</b> This calls out the specific tools and equipment required for this process
	<b>REVISION MARK:</b> This mark highlights a change in installation with respect to previous issue.

Care must be taken when installing this accessory to ensure damage does not occur to the vehicle. The installation of this accessory should follow approved guidelines to ensure quality installation.

## Preparation



Remove negative battery cable

- Place the vehicle in Park with the parking brake set.

**Hybrid vehicles, the battery is in the trunk**

- Remove the Battery Cover (for hybrid vehicles only)

**Gas vehicles, the battery is in the Engine compartment**

- Remove battery from vehicle
  - Note the Battery Cable Position as it will be re-installed in the same position

CAUTION: do not touch the positive battery terminal

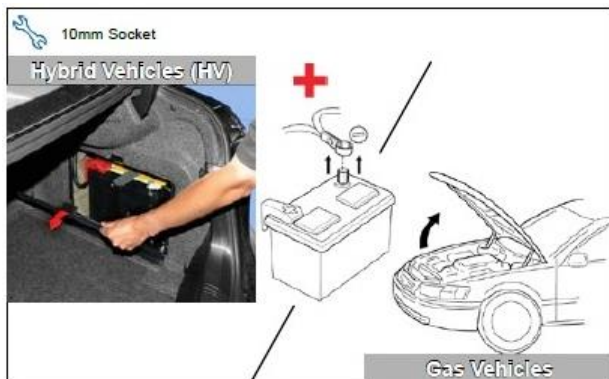

## Installation

*Hybrid models proceed to steps 4 ~ 13.*

- Secure the relay and fuse to the battery negative cable with wire ties. Secure top and bottom with wire ties. See yellow marks on picture 1 for wire ties locations.
- Attach the ring terminal with 2 black wires (from Fog Light harness) to the 10mm (ground) nut next to the relay (picture 1)

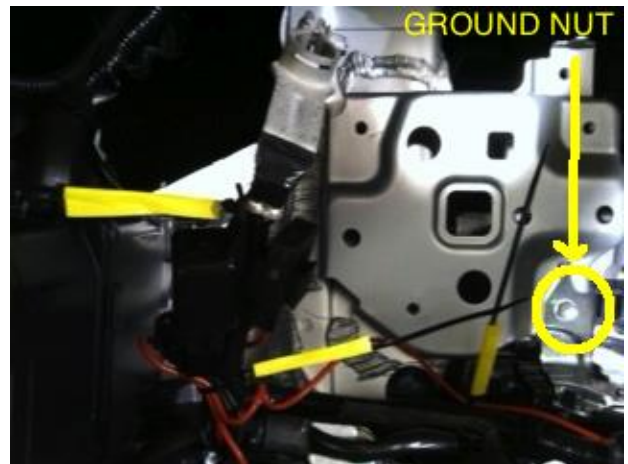

Picture 1

- Connect the ring terminal from the relay (from Fog Light harness; 12v red wire) routing it through positive red terminal cover. Use wire ties to secure wire harness to the positive cable from battery (picture 2).

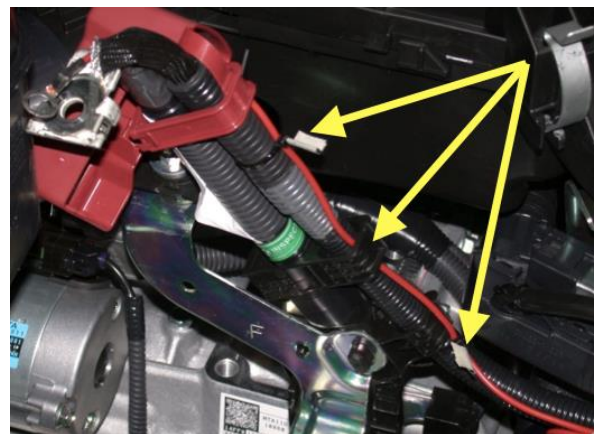

Picture 2

- (Hybrid models only, steps 4~13)** In the engine compartment, remove the push pins holding the driver side plastic cowl on top of the head lamp (pictures 3 and 3A)



Pictures 3



Picture 3A

5. **(Hybrid)** Secure the black ring terminal of the fog light harness to the 10 mm bolt on top the driver side frame (picture 4)

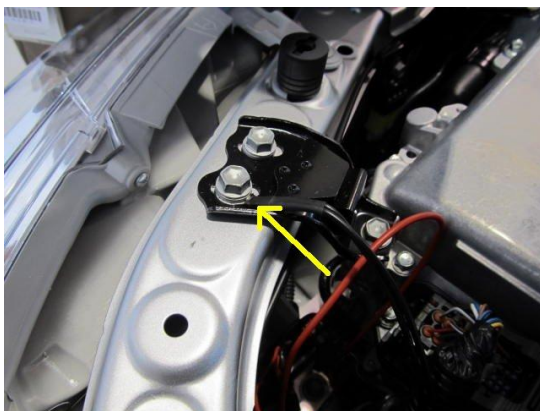

Picture 4

6. **(Hybrid)** Secure the relay and fuse to the factory wire harness in front of the fuse box (pic. 5)

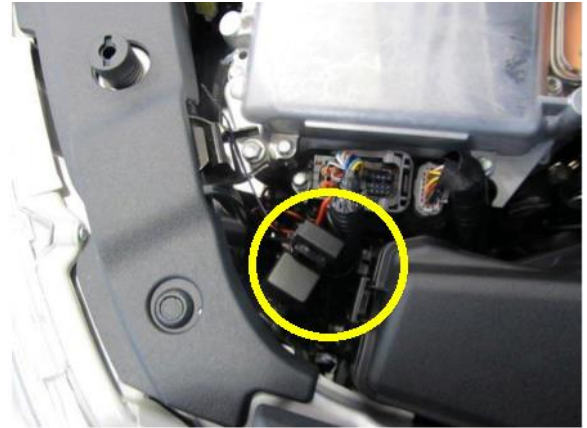

Picture 5

7. **(Hybrid)** Disconnect the white wire harnesses in the middle of the fuse box (picture 6)



Picture 6

8. **(Hybrid)** With a 10 mm socket, remove the positive nut in the center of the fuse block: + positive terminal (picture 7)

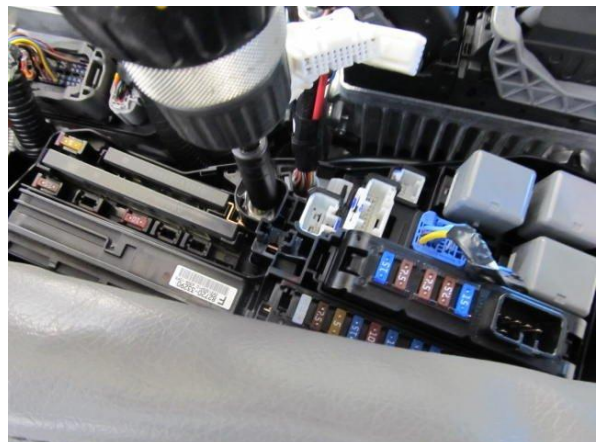

Picture 7



9. **(Hybrid)** Lift up the harness assembly (picture 8)



Picture 8

10. **(Hybrid)** Run the positive ring terminal of the fog light harness through the area of fuse block (picture 9)



Picture 9

11. **(Hybrid)** Place the red ring terminal of the fog light wire harness in the positive terminal of the fuse box (picture 10)

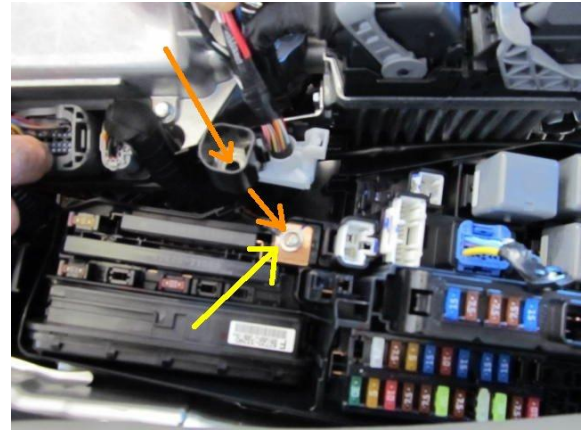

Picture 10

12. **(Hybrid)** Reposition the harness assembly and lock into place. Tighten nut (picture 11)

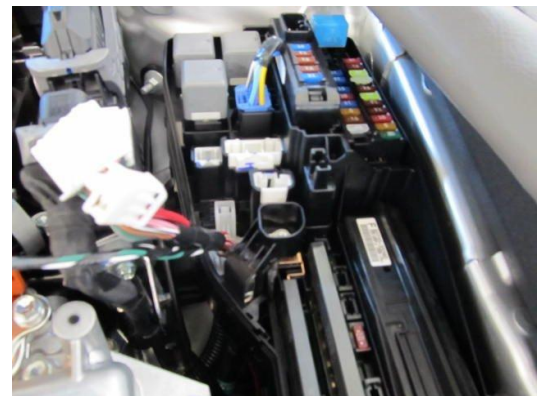

Picture 11

13. **(Hybrid)** Reconnect white wire harnesses removed in step 7
14. Route the fog light wire harness along the driver side from the battery (Hybrid: from left front) towards the bulkhead of the vehicle. Secure the wire harness with wire ties as needed (picture 12 & 12B: showing for regular and hybrid engine layout)



Picture 12



Picture 12B: Hybrid Models

15. Locate the large vehicle harness grommet on the left side. If accessible, cut the auxiliary wiring access nipple off the grommet or cut 1/4" slit in grommet and push the red and gray/white wires through firewall. Note: Extra caution should be taken not to damage the bullet connectors. Seal with 3M Silicone sealant (picture 13)



Picture 13

### Vehicle Disassembly

16. Remove driver side door scuff plate
  - a. Disengage with panel tool and remove (see picture 14)

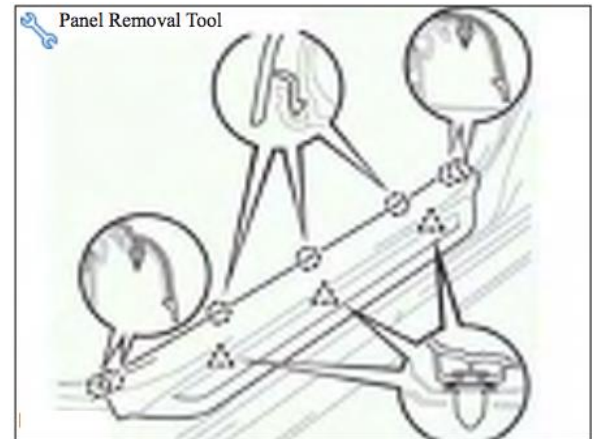

Picture 14

17. Remove the driver side cowl side trim (see picture 15)
  - a. Unscrew the cowl side trim clip
  - b. Disengage two (2) clips and remove the cowl side trim (picture 15)



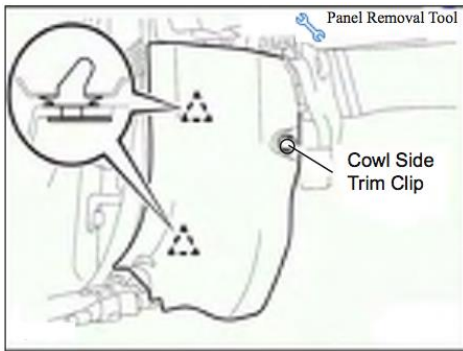

Picture 15

18. Remove the finish panel covering the knee airbag, lower airbag and move aside to access behind dashboard.
19. Remove side panel from dash, pry outward at front edge then pull straight back (pic. 16)



Picture 16

20. Remove dash plug then mount switch into switch knockout on left side of dash (pic. 17)



Picture 17

21. From inside the cabin, locate the wires that were pushed through in step 15. It will be the grommet above the gas pedal.
22. Route the wire harness to reach out the lower part of the steering wheel
23. T-tap the green/black wire from fog light harness to connector ID 3D pin 39, white wire. Connector ID 3D is left of steering wheel (pictures 8 and 9)
24. T-Tap orange/black wire from fog light harness to connector ID 3D pin 12, pink wire (pictures 18 and 19)

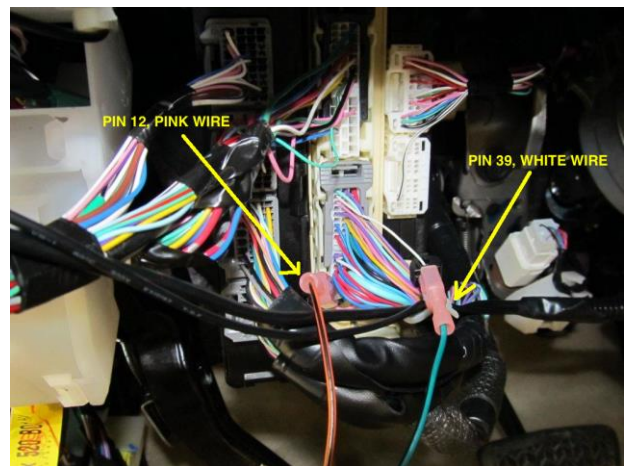

Picture 18

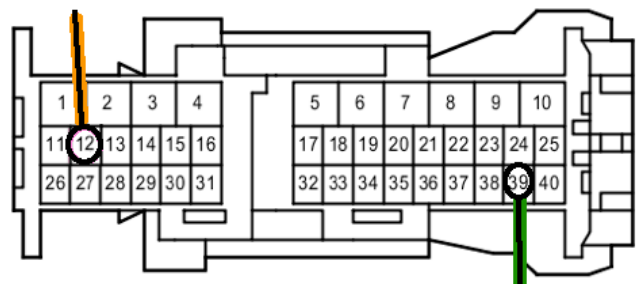

Picture 19: ID 3D  
 Orange-Black to Pin 12, Pink wire  
 Green-Black to Pin 39, White wire

25. Install switch harness into switch
26. Secure fog light excess wires and relay with wire ties (picture 20)

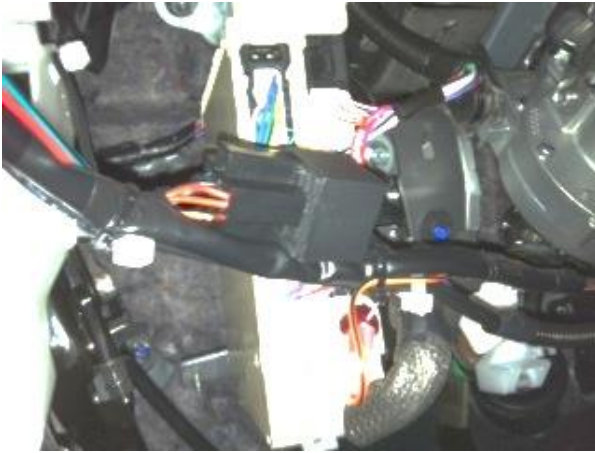

Picture 20

27. Reinstall panels. When reinstalling airbag in lower knee panel, follow specifications on picture 21

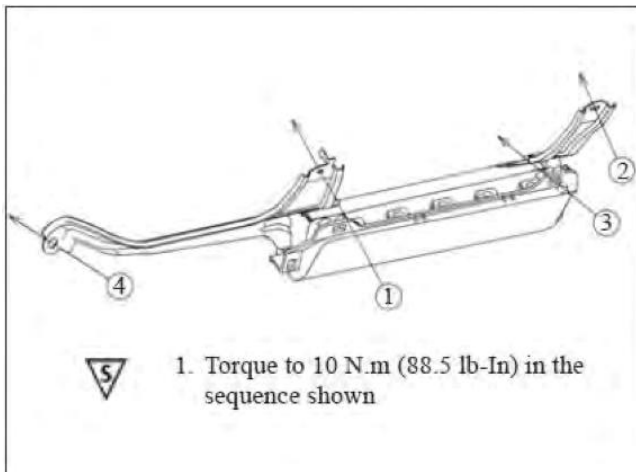

Picture 21

### ENGINE COMPARTMENT

28. On the driver side, route the fog light wire under car to reach out left fog light area.
29. Remove lower splash shields on both sides and then fog light cover plates
30. Insert one side of the fog light into the plastic sleeve and secure other side with supplied Phillip screws (picture 22). Repeat this step for left and right fog lamps.



Picture 22

31. Note: For Halogen installations, proceed to step 32. For LED installations; The LED fog light wires may not be pushed into their connectors. If not, push the negative wire (black or black-white) into Pin 2 of the connector. Then, push the positive wire (red or red-white) into Pin 1 of the connector. See Picture 23 below.



**LED Lights will NOT work if the polarity is reversed. Be sure the red positive wire of the harness matches the red positive wire of the light housing, and the black negative wire of the harness matches the black negative wire of the light housing.**

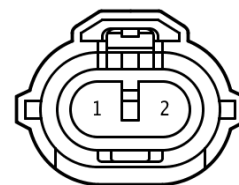

Picture 23

32. Plug in left side fog light into harness plug and secure with wire ties

- 33. Run right side of wire harness under skid plate and secure with wire ties (picture 24)



Picture 24

- 34. Plug in right fog light into harness plug and secure with wire ties
- 35. Snap on both fog light bezels (picture 25)



Picture 25

- 36. Reattach the lower splash shields

- 37. Replace Battery and reconnect negative battery cable. Torque to 61 in/lbs.



Avoid compressing relay against battery.

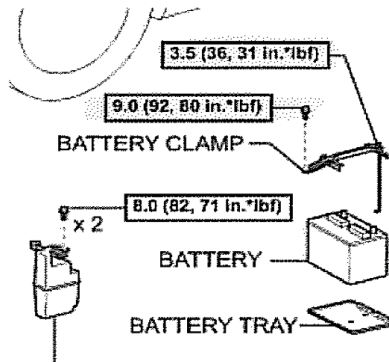

Picture 26



**Checklist** – these points MUST be checked to ensure quality installation**Check System for Operation**

1. Turn on headlamp low beams, then press fog light switch to “ON” position. Fog lights should be working. Fog lights will only work when the low beam headlamps are “ON”. Fog lights will NOT work when the high beam headlamps are “ON”

**Fog Light Aiming**

**NOTE:** Use only hand tools to adjust the fog light aiming screw. DO NOT use power assisted tools, as they will damage the fog light

Traditional fog lights are usually mounted in the front bumper about 10-24 inches from the ground. There are two important issues to address when installing fog lights: the first is to minimize the amount of return glare into the driver's eyes, and the other is to minimize the glare into oncoming eyes. Both of these issues must be accomplished while putting as much light as possible on the road.

These fog weather light aiming instructions are suggestions taken from common practice and the S.A.E. standard J583. Some modifications to these instructions may be necessary to minimize glare.

Visual aim is made with the top of the beam 4 inches below the lamp center at 25 feet with the lamp facing straight forward (see picture 27)

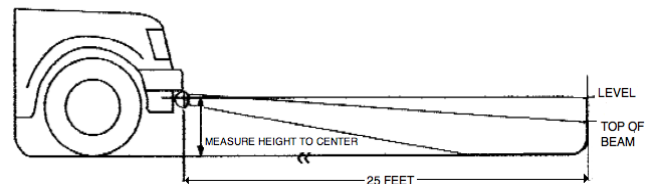

Picture 27

**Check**

Accessory Functions Checks

---

- Fog Lights function.....
- All Panels snapped into place.....
- Battery Terminal.....

Vehicle Function checks

---

- Check all vehicle functions

**Look For:**

---

- Inoperable fog light function
- Loose panels and switches
- Re-torque battery terminals to 61 in-lb