

AP[®]

APCLE-1000ID
Class D Power Amplifier
1000W

APCLE-1500ID
Class D Power Amplifier
1500W



With Remote Bass Knob

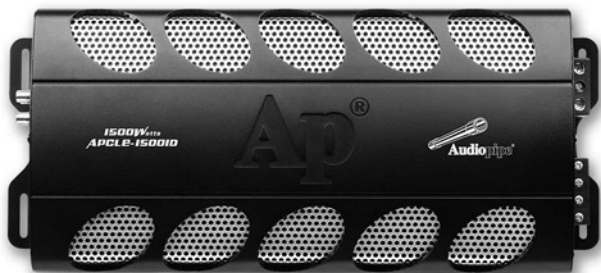

Owner's Manual



INTRODUCTION

Congratulations!

Thank you for purchasing Audiopipe Class D amplifier for your car audio system. Now you own an amplifier of uncompromising design and engineering incorporating the latest advanced circuit technology. You will discover soon that our amplifiers display optimum sound with high quality, reliable performance.

Audiopipe amplifiers are adopted by advanced craftsmanship which using the highest quality components and strict quality control system. In order to provide you the best performance.

Please read this manual thoroughly to ensure that you can get the maximum benefit from this new amplifier. When you install it properly, this unit will provide you years of trouble-free performance.

- 1 Ohm load stable.
- Double side FR-4 PCB, high quality SMD components.
- Full MOSFET circuit design.
- Subsonic adjustable.
- Low pass filter adjustable.
- Bass boost frequency and level adjustable.
- Phase adjustable.
- Overload, short circuit, thermal, low voltage protection.
- Easy bridging operation.
- Remote bass level control (with remote bass knob).

AMPLIFIER FUNCTIONS

① Speaker connection

Never connect the speaker cables with the chassis ground. This may destroy your amplifier. Check that your speakers are connected correctly which means plus to plus and minus to minus. We recommend speaker cable from 2.25 mm to up. The connection ways are shown in the attachment.

② BATT+

Battery + terminal. The +12 Volt power cable must be connected with a fuse in line near the battery + terminal. Please see the table of cable and fuse selection.

③ REM

Remote terminal. The remote cable must be connected with the radio remote terminal so that the amplifier will switch on and off automatically with the radio. If there are two or more amplifiers installed together, it might be necessary to add an additional relay. Please consult your dealer.

④ GND

Chassis ground terminal. The chassis ground cable must be connected very tight on a nearby massive and electric conductive place.

⑤ Gain

Gain control regulates the sensitivity of the amplifier to match the signal output voltage of your source unit. The gain control is not a volume adjustment. Use high quality CD music and increase the volume of your source unit to 75% posit, set the gain at the minimum and then increase gain slowly (clockwise). Stop at the first sign of distortion, then lower the gain a little (counter clockwise) to achieve clear undistorted music at the maximum level.

⑥ Remote Bass Level Control

When using the remote bass level control you can adjust volume in the driver seat.

⑦ RCA audio input

These RCA audio inputs connect with your radio RCA outputs. Please use car audio RCA cables, otherwise it may be disturbed. Keep these cables as short as possible. To avoid disturbances from your car electronics, please don't close the existing car cables when you install the RCA cables. If your radio has only one set output, please use a suitable Y-RCA adaptor. If your radio has only speaker output, you must use a HIGH LOW LEVEL adaptor.

⑧ Run Indicator

This LED will light up when amplifier work properly, it will flash or shut down once amplifier in self-testing or malfunction.

⑨ **Bridge in**

This RCA jack receives signal from the master amplifier when this amplifier is bridged as slave. DO NOT use input jacks when the amplifier is working as slave. All the functions will be adjusted by the master amplifier.

⑩ **Bridge out**

This RCA output sent out bridge signal to another same Class D amplifier in bridging configuration

⑪ **Low Pass Filter**

Filter out high frequency that the woofer can't play. Adjust this knob to match the woofer's frequency response.

⑫ **SUBSONIC**

Filter out unwanted too low frequency. This function will increase the power handing of your woofer's. It can adjust the frequency filter from, 10Hz (OFF) to 50Hz.

⑬ **Bass boost Frequency**

Adjust the boosted center frequency. The frequency can be adjusted from 0Hz to 80Hz, use combine with bass boost level adjusting.

⑭ **Bass boost Level**

Adjust the boosted frequency from 0 ~ 12dB.

⑮ **Alarm Indicator**

When this LED light up, the amplifier may in self-test mode (when power up) or malfunction. Shut down the amplifier immediately can find the reason before power up amplifier again.

APCLE-10001D / APCLE-15001D

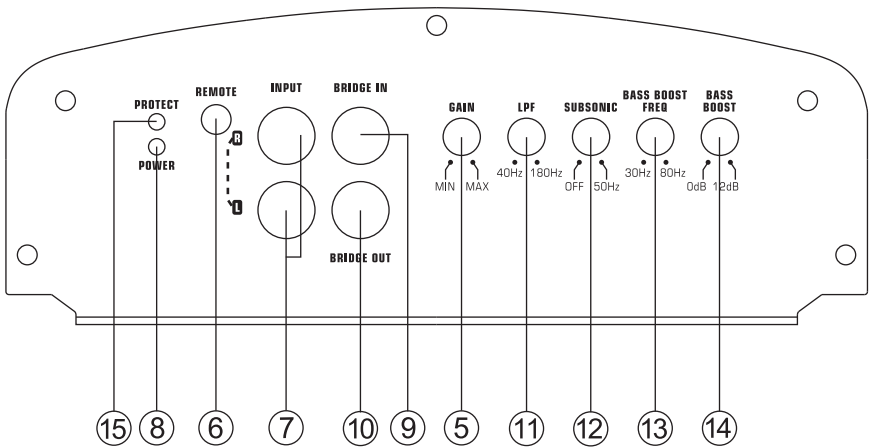
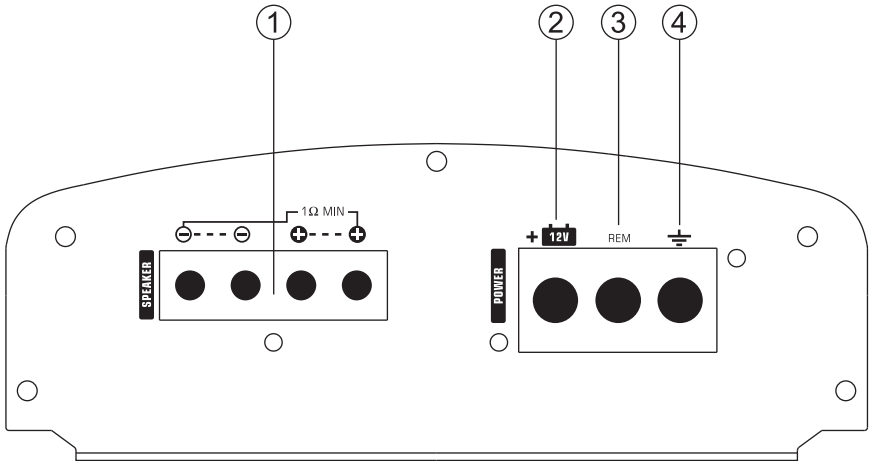

PREINSTALLATION

We recommend to have the installation done by an Authorized Audiopipe Dealer. Required power, ground wire and proper external fuse as below:

Model	Fuse	Wire
APCLE-10001D	80 AMP	4 Gauge
APCLE-15001D	100 AMP	2 to 4 Gauge

We recommend a fuse should be installed away 0.2m from the battery. The ground wire should be connected directly with the chassis of your vehicle which should be metal to metal ground point connection. The amplifier must be mounted securely at a solid, dry and low vibration surface in the trunk or passenger area. Fix the amplifier in an open air area to insure proper heat dissipation. Fix the amplifier in a place where can access easily to set the input controllers. Install all amplifier cables as far as possible from car electrical cables such as the car ignition cable.

IMPORTANT:

- When bridging two amplifiers please refer the bridging wiring chart.
- When bridging two amplifiers you should use same model amplifiers.
- Please make sure the negative speaker terminal of two amplifiers are connected by the same gauge cables as the positive terminal being used.
- DO NOT connect any signal cables with the input RCA jacks when bridged as slave unit.
- The LPF, Input level and remote functions will be disabled on slave amplifier when bridged.
- All the functions of the slave amplifier will be adjusted by the master amplifier.

WIRING CONFIGURATION

ONE SPEAKER MONO APCLE-10001D / APCLE-15001D

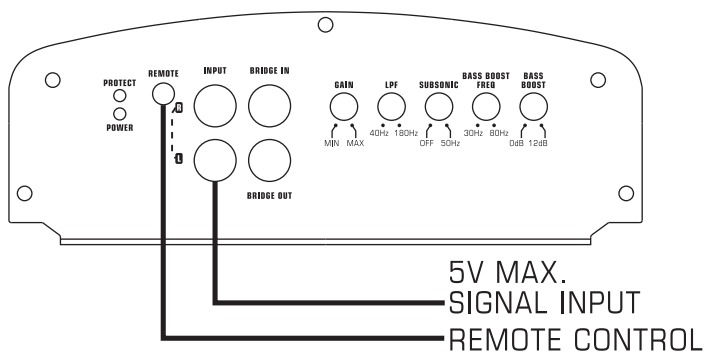
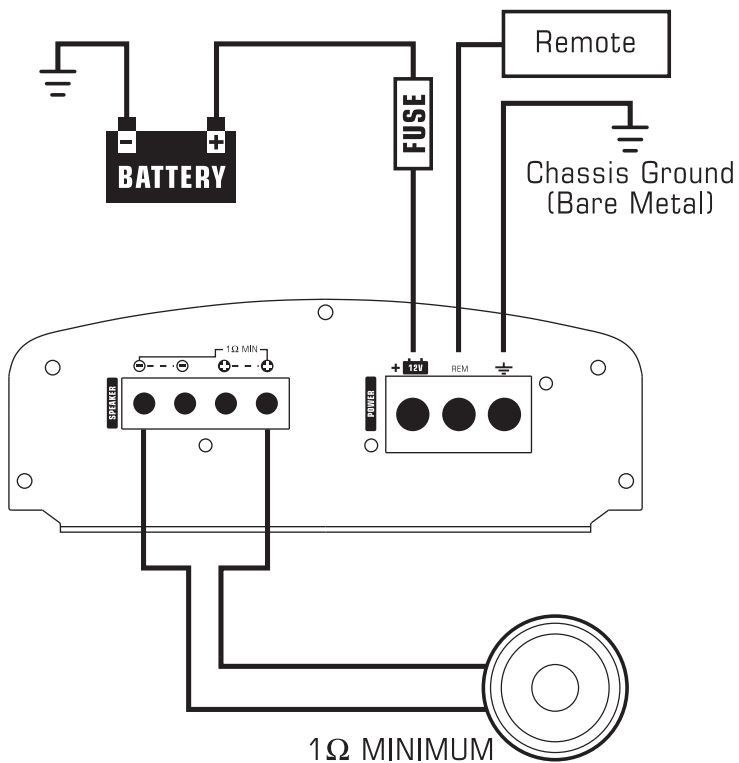

TWO SPEAKER MONO APCLE-10001D / APCLE-15001D

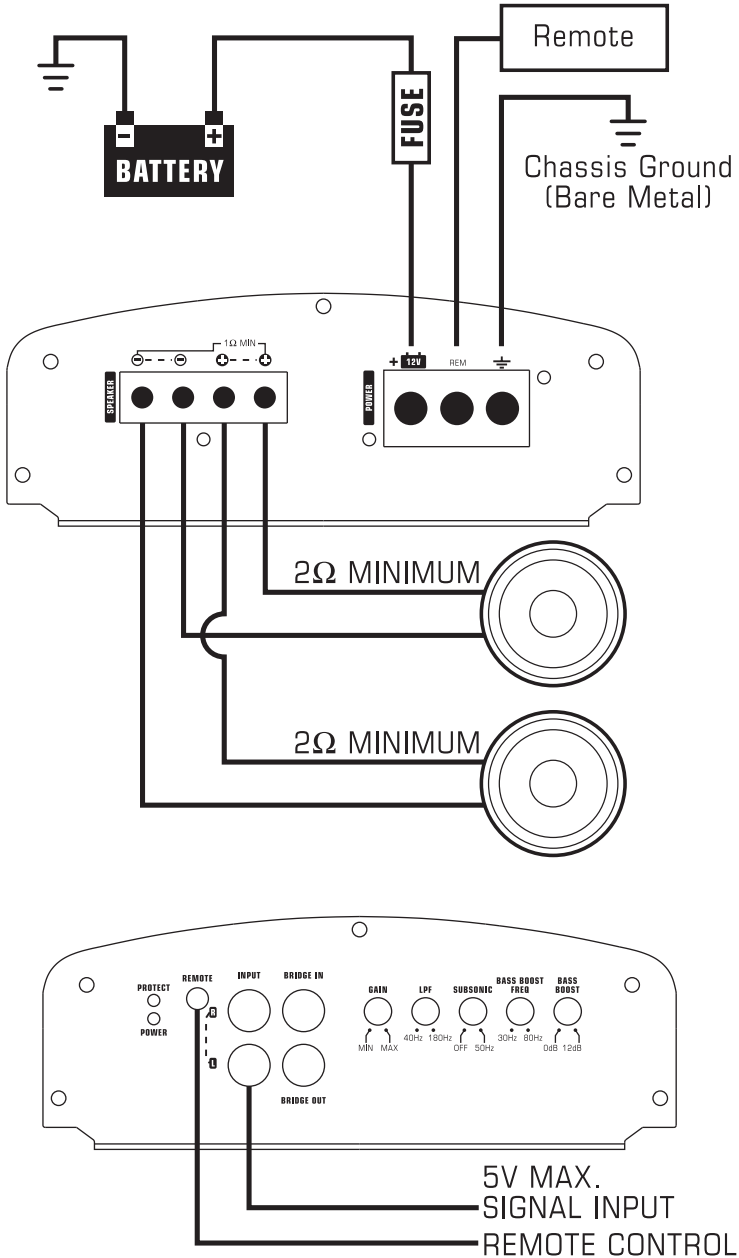

TWO AMPLIFIER LINKED TO ONE CHANNEL

APCLE-10001D / APCLE-15001D

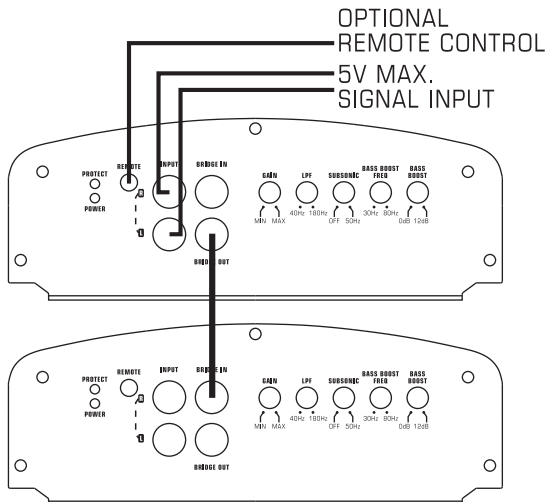
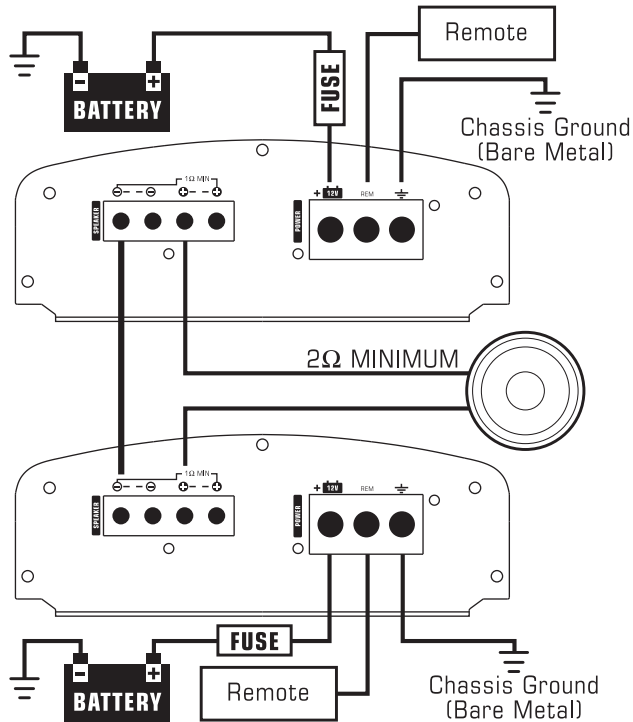

TROUBLESHOOTING

Problem

Run indicator doesn't light up.

Solution

- *Check all fuses on the amplifier.*
- *Check main fuse near the battery.*
- *Check plus and minus battery cables.*
- *Check remote voltage.*

Problem

Run indicator is on but no sound.

Solution

- *Check volume control on the radio.*
- *Check GAIN regulator on the amplifier.*
- *Check RCA cables and connections.*
- *Check speaker cables and connections.*

Problem

Bass response is low.

Solution

- *One speaker cable could be disconnected the bass control on the radio is set on low an active cross over is adjusted wrong.*

Problem

The amplifier switches on and off.

Solution

- *Bad chassis ground connection with amplifier cable terminals and battery terminals are oxidized low voltage from the battery remote wire is connected wrong.*

PRODUCT SPECIFICATIONS

APCLE-10001D

Maximum Power Output	1000W
Continuous Power Output	1 Ch-400W @ 4 Ohm 1 Ch-600W @ 2 Ohm 1 Ch-1000W @ 1 Ohm
Frequency Response	8Hz ~ 180Hz
Signal Noise Ratio	70dB
Bass Boost Level	30 ~ 80Hz
THD	<0.15%
Input Sensitivity Low Level	0.2 ~ 5V
Input Sensitivity Speaker Level	5 ~ 50Hz
Dimensions	(H)55 x (W)176 x (L)288 mm

APCLE-15001D

Maximum Power Output	1500W
Continuous Power Output	1 Ch-600W @ 4 Ohm 1 Ch-950W @ 2 Ohm 1 Ch-1500W @ 1 Ohm
Frequency Response	8Hz ~ 180Hz
Signal Noise Ratio	70dB
Bass Boost Level	30 ~ 80Hz
THD	<0.15%
Input Sensitivity Low Level	0.2 ~ 5V
Input Sensitivity Speaker Level	5 ~ 50Hz
Dimensions	(H)55 x (W)176 x (L)357 mm