



Installation Manual v1.3:

601-950-2104

Select Shift Standalone [Transmission Controller](#)
94-2013 Dodge 47/48 4-Speed Automatic

Please read all instructions before installation.



The Standalone Transmission Controller:

The Standalone Transmission Controller is the most advanced way to control the 47re and 48re transmissions, giving complete control over your transmission. This permits tuning of every aspect of your transmission such as full torque converter lockup control, full shift point control, line pressure adjustment, shift quality control, and independence from the factory control and logic.

The Standalone Transmission Controller changes your transmission from a governor and throttle valve based shift control to complete independent line pressure and shift control. Converting your mechanical transmission to a modern fully electronic transmission, opening a whole new world of possibility!

TCU Location and Wire Routing

Please keep the TCU away from extreme heat sources, ignition wires or any obvious water sources. Once you have chosen a location for your TCU, you may begin routing the wiring harness. Be careful to avoid moving and/or hot parts when routing the harness. Route the harness to your sensor locations and wire them as noted. Route the connectors and wires down towards the transmission. Watch for possible fitment issues or places where the harness can rub or be damaged over time.

Power and Ground Connections

The TCU requires an active power and ground connection to operate correctly. The power connection to the TCU should be switched (only turns on when you turn the ignition key to the start/run position). If you wire the TCU to a constant power source, you risk **severe** damage to the TCU and your transmission. The power source should be protected with a 10amp fuse (this can vary based on the transmission application). Your switched power source should also be capable of providing at least 10 amps (or more depending on your transmission application) and should come from a clean terminal or wire. If you splice into a wire or create a switched power junction, please protect and seal the wire or joint with sealant type heat shrink or something similar to ensure reliability.

RED Wire (12V Supply):

This wire is used for supplying 12V power to the transmission. Use a key on source to prevent battery draw. The standalone controller's memory will not be lost when power is removed.

BLACK Wire (Ground):

This wire is used to ground the Standalone controller. Use constant ground preferably at the battery negative terminal. A bad ground will cause very erratic behavior.

Digital Inputs:

The TCU has sixteen digital inputs which are provided for simple on/off devices. An important function of the digital inputs is gear selection. Most transmissions require several digital inputs be wired to the transmission or lever position switch to determine which gear the driver has selected. A brake light input is another important use of a digital input. When activated, this input will unlock the torque converter clutch (TCC). Additional on/off inputs may include buttons for mode switching (performance mode, tow mode, manual mode, etc). Each digital input has five parameters to consider: Function, active high or active low, button type (momentary or toggle), and reverse logic. This programmability allows the user to wire the digital inputs in almost any configuration or with almost any type of switch and still function properly. Select **active high** for inputs that are on when power is applied. Select **active low** for inputs that are on when ground is applied. Select **momentary** for buttons that are depressed for a short time period before returning to their original state. Select **toggle** for buttons that are depressed or moved and stay in their position until moved again. Select **reverse logic** for buttons or switches that are active when neither power nor ground is applied and inactive when power or ground is applied.

Digital inputs used on a 1994-1998 Dodge 12-Valve:

- BROWN with Black Stripe** (optional switch input)
- BROWN with PINK Stripe** (4wheel drive indication). This is not used. It can be used as a switched input.
- BROWN with WHITE Stripe** (overdrive cancel signal). This is wired in to the overdrive switch. A standard switch will work.

Digital inputs used on a 1998-2002 Dodge 24-Valve:

- BROWN with Black Stripe** (optional switch input)
- BROWN with PINK Stripe** (4wheel drive indication). This is not used. It can be used as a switched input.
- BROWN with WHITE Stripe** (overdrive cancel signal). This is wired in to the overdrive switch. A standard switch or the factory switch will work.

Locate the OD (Overdrive) wire in the vehicle's computer wiring harness. This ***Orange with White Stripe*** wire is located at pin **13** of the C3 PCM connector (PCM connectors are behind the air box on the passenger-side firewall, the C3 connector is the one closest to fender).

Digital inputs used on a 2003-2007 Dodge:

-**BROWN with Black Stripe** (optional switch input)

-**BROWN with PINK Stripe** (4wheel drive indication). This is not used. It can be used as a switched input.

-**BROWN with WHITE Stripe** (overdrive cancel signal) This is wired in to the overdrive switch. A standard switch or the factory switch will work

Locate the OD (Overdrive) wire in the vehicle's computer wiring harness. Locate the PCM on the driver side of the engine block. The C2 connector is a 50 pin connector , located closer to the transmission. This wire is optional. Tap the **Dark Green** wire that goes to **Pin 13** of the **C2** PCM connector to use the factory signal.

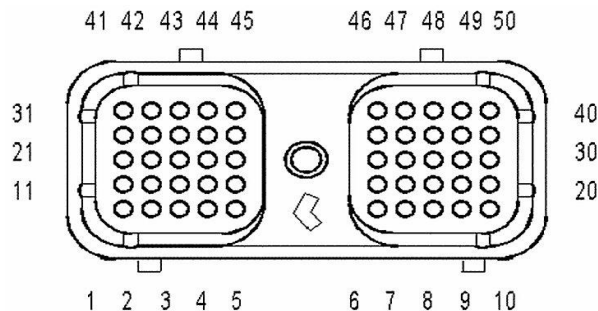

MODULE- ENGINE CONTROL C2

Analog Inputs:

The TCU has six analog inputs which read a 0-5V scaled input. Analog inputs are important for a variety of sensors such as throttle position (TPS), manifold absolute pressure (MAP), engine coolant temperature (ECT) and transmission fluid temperature (TFT). An analog input can also be used with stock steering wheel buttons, like cruise control and volume control, on some vehicles where different buttons correspond to different voltages. These voltages can be programmed to perform up shifting and downshifting when in manual mode.

Analog inputs 1-4 have been designed so that they can piggyback any sensor from an engine controller or directly measure most sensors. Analog inputs 1-4 should not be used to directly measure any temperature sensors or other resistance based 2-wire sensors. Analog inputs 5-6 should not be used to piggyback any sensors from an engine controller. Analog inputs 5-6 should be used to directly measure any temperature sensors or other resistance based 2-wire sensors.

Analog Inputs used on a 1998 -2002 Dodge:

-YELLOW with RED Stripe (MAP)

OPTIONAL: This is used as an engine load indicator. A 0-100 PSI pressure sensor can be purchased from ATS Diesel Performance if desired.



-YELLOW with ORANGE Stripe (ENGINE COOLANT TEMP). This is not used.

-YELLOW with BLACK Stripe (TPS)

This wire is NOT optional. This wire tells the controller the desired power level.

If you have the square connector, use **Pin 3 LB/BK APP Sensor Signal**. This signal will need to be scaled in the software. If you have the older 3 wire connector, tap **Pin 2 OR/BK TP Sensor Signal**. This will also need to be scaled in the software.

ACCELERATOR PEDAL POSITION SENSOR

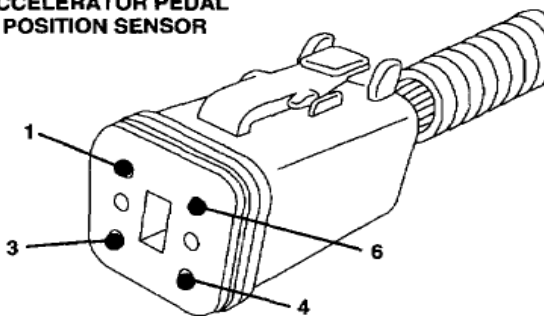

CAV	COLOR	FUNCTION
1	BK/LB	SENSOR GROUND
2	LG/DB	IDLE VALIDATION (NOT IDLE)
3	LB/BK	APP SENSOR SIGNAL
4	BK/YL	SENSOR RETURN (APPS)
5	DB/WT	5-VOLT SUPPLY
6	BR/OR	IDLE VALIDATION (IDLE)

THROTTLE POSITION SENSOR CONNECTOR

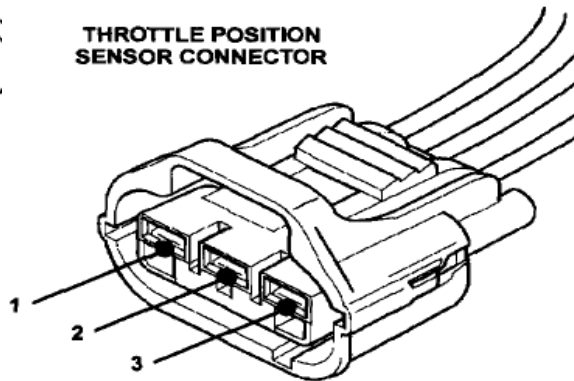

CAV	COLOR	FUNCTION
1	VT/WT	5-VOLT SUPPLY
2	OR/DB	TP SENSOR SIGNAL
3	BK/LB	SENSOR GROUND

Analog Inputs used on a 1994 -1998 Dodge 12-Valve:

-YELLOW with RED Stripe (MAP)

OPTIONAL: This is used as an engine load indicator. A 0-100 psi pressure sensor can be purchased from ATS Diesel Performance if desired.

-YELLOW with ORANGE Stripe (ENGINE COOLANT TEMP). This is not used.

-YELLOW with BLACK Stripe (TPS)

This wire is NOT optional. This wire tells the controller the desired power level.

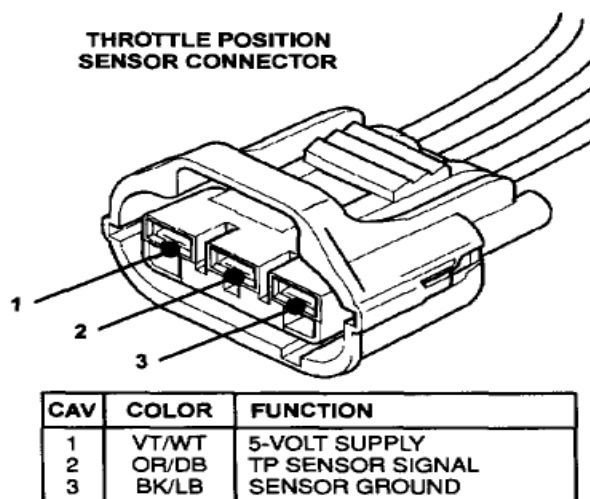

If you have the 3 wire connector, tap **Pin 2 OR/BK TP Sensor Signal**. This will also need to be scaled. We also offer a remote mount TPS sensor, found later on in the instructions.

Analog Inputs used on a 2003 Dodge:

-YELLOW with RED Stripe (MAP). This wire is optional. Tap into **Pin "A" LB/WT Map Sensor Signal**.

2003 Dodge MAP Sensor Scaling:

Below shows how the 5.9L MAP sensor is scaled into the TCU.

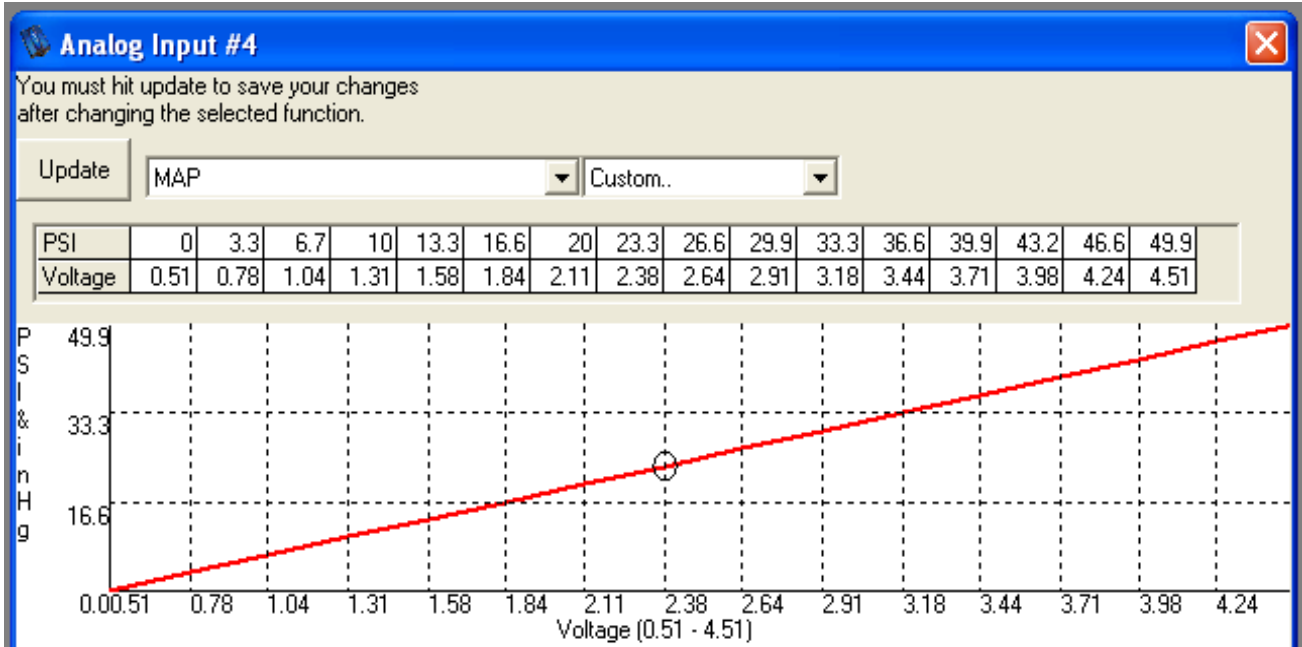

-YELLOW with ORANGE Stripe (ENGINE COOLANT TEMP) This is not used.

-YELLOW with BLACK Stripe (TPS)

This wire is NOT optional. This wire tells the controller the desired power level. Tap into **Pin 3 YL Throttle Position Signal**. This signal will need to be scaled.

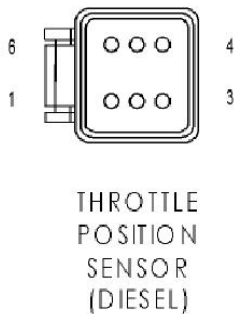

THROTTLE POSITION SENSOR (DIESEL) - 6 WAY

CAV	CIRCUIT	FUNCTION
1	K104 18RD/WT	SENSOR GROUND
2	K101 18WT	THROTTLE POSITION SENSOR RETURN
3	K232 18YL	THROTTLE POSITION SIGNAL
4	K56 18LG/OR	SUPPLY VOLTAGE
5	K900 18DB/DG	SENSOR GROUND
6	K49 18VT/BK	No Function Defined

Analog Inputs used on a 2004-2005 Dodge:

-YELLOW with RED Stripe (MAP)

This wire is optional. Tap into *Pin "A" LB/WT MAP Sensor Signal.*

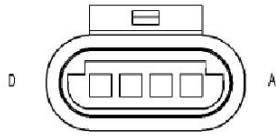

INTAKE AIR TEMPERATURE/
MANIFOLD ABSOLUTE PRESSURE SENSOR (DIESEL)

INTAKE AIR TEMPERATURE/MANIFOLD ABSOLUTE PRESSURE SENSOR (DIESEL) - 4 WAY

CAV	CIRCUIT	FUNCTION
A	K55 18LB/WT	MAP SENSOR SIGNAL
B	K21 18BK/RD	INTAKE AIR TEMPERATURE SENSOR SIGNAL
C	K72 18DG/OR	5 VOLT SUPPLY
D	K9 18LB	5 VOLT SUPPLY

-YELLOW with ORANGE Stripe (ENGINE COOLANT TEMP). This is not used.

-YELLOW with BLACK Stripe (TPS)

This wire is NOT optional. This wire tells the controller the desired power level.

For 2004 models: Locate the APPS, it is under a black plastic cover, on the driver's side of the engine, in front of the intake manifold. Tap the ***Brown with White Stripe*** wire in the APPS plug wire loom.

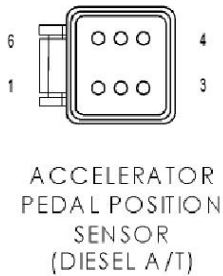
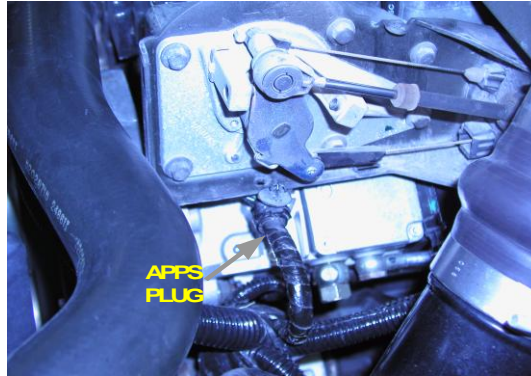

ACCELERATOR PEDAL POSITION SENSOR (DIESEL A/T)

ACCELERATOR PEDEL POSITION SENSOR (DIESEL A/T) - 6 WAY

CAV	CIRCUIT	FUNCTION
1	K914 18RD/WT	SENSOR GROUND
2	K556 18OR/BR	NOT IDLE SWITCH
3	K22 18BR/WT	TP SIGNAL
4	K922 18LG/OR	THROTTLE POSITION SENSOR RETURN
5	K851 18VT/PK	5-VOLT SUPPLY
6	K565 18OR	IDLE SWITCH

For 2005 models: Connect at the TPS connector located at the top of the accelerator pedal arm. This is a six wire connector, in the fifth terminal there is a **Brown with White Stripe** wire, tap this wire.

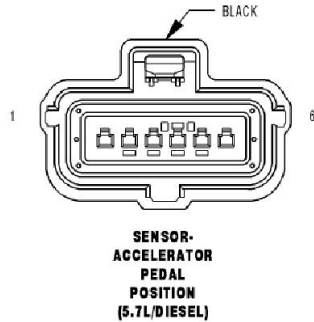

SENSOR-ACCELERATOR PEDAL POSITION (5.7L/DIESEL) - BLACK 6 WAY		
CAV	CIRCUIT	FUNCTION
1	F856 20YL/PK	5 VOLT SUPPLY
1	K854 20VT/BR (DIESEL)	5 VOLT SUPPLY
2	K29 20VT/BR	APPS NO. 2 SIGNAL
3	K400 20BR/VT	APPS NO. 2 RETURN
4	K167 20BR/YL	APPS NO. 1 RETURN
5	K23 20BR/WT	APPS NO. 1 SIGNAL
6	F855 20PK/YL	5 VOLT SUPPLY
6	K852 20BR/VT (DIESEL)	5 VOLT SUPPLY

Analog Inputs used on a 2006-2007 Dodge:

-**YELLOW with RED Stripe** (MAP). This wire is optional. Tap into **Pin "A" LB/WT MAP Sensor Signal**.

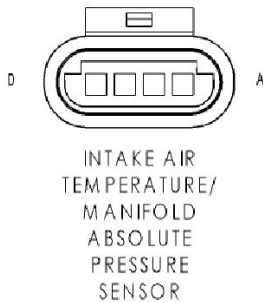

INTAKE AIR TEMPERATURE/MANIFOLD ABSOLUTE PRESSURE SENSOR (DIESEL) - 4 WAY		
CAV	CIRCUIT	FUNCTION
A	K55 18LB/WT	MAP SENSOR SIGNAL
B	K21 18BK/RD	INTAKE AIR TEMPERATURE SENSOR SIGNAL
C	K72 18DG/OR	5 VOLT SUPPLY
D	K9 18LB	5 VOLT SUPPLY

-**YELLOW with ORANGE STRIPE** (ENGINE COOLANT TEMP) This is not used.

-**YELLOW with BLACK STRIPE** (TPS)

This wire is NOT optional. This wire tells the controller the desired power level. Tap in to the **Brown with White Stripe** wire.

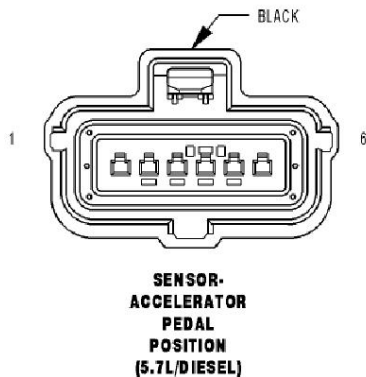

SENSOR-ACCELERATOR PEDAL POSITION (5.7L/DIESEL) - BLACK 6 WAY		
CAV	CIRCUIT	FUNCTION
1	F856 20YL/PK	5 VOLT SUPPLY
1	K854 20VT/BR (DIESEL)	5 VOLT SUPPLY
2	K29 20VT/BR	APPS NO. 2 SIGNAL
3	K400 20BR/VT	APPS NO. 2 RETURN
4	K167 20BR/YL	APPS NO. 1 RETURN
5	K23 20BR/WT	APPS NO. 1 SIGNAL
6	F855 20PK/YL	5 VOLT SUPPLY
6	K852 20BR/VT (DIESEL)	5 VOLT SUPPLY

Analog Inputs used on a 2007.5-2013 Dodge 6.7L Cummins:

-YELLOW with BLACK Stripe (TPS)

For 2007.5-2013 models: Connect at the TPS connector located at the top of the accelerator pedal arm. This is a six wire connector, in **Pin 5** there is a **Brown with White Stripe** wire, tap this wire.

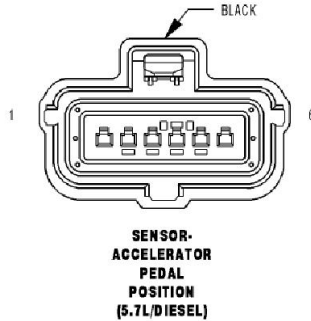

SENSOR-ACCELERATOR PEDAL POSITION (5.7L/DIESEL) - BLACK 6 WAY		
CAV	CIRCUIT	FUNCTION
1	F856 20YL/PK	5 VOLT SUPPLY
1	K854 20VT/BR (DIESEL)	5 VOLT SUPPLY
2	K29 20WT/BR	APPS NO. 2 SIGNAL
3	K400 20BR/VT	APPS NO. 2 RETURN
4	K167 20BR/YL	APPS NO. 1 RETURN
5	K23 20BR/WT	APPS NO. 1 SIGNAL
6	F856 20PK/YL	5 VOLT SUPPLY
6	K852 20BR/VT (DIESEL)	5 VOLT SUPPLY

*Connector sizes and shape changes but the pin out stays the same

-YELLOW with RED Stripe (MAP). This wire is optional. Tap into **Pin "1"** **Brown MAP Sensor Signal**.

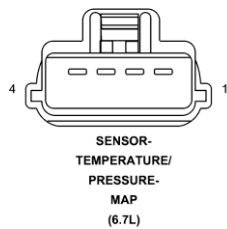

CAVITY	CIRCUIT	FUNCTION
1	K37 18BR	BOOST PRESSURE SENSOR SIGNAL
2	F855 18PK/YL	5 VOLT SUPPLY
3	K21 18DB/LG (DC)	INTAKE AIR TEMPERATURE SENSOR SIGNAL
3	K48 18DB/WT (DH)	CHARGE AIR COOLER TEMP SIGNAL
4	K916 18BR/OR	SENSOR GROUND

-YELLOW with ORANGE STRIPE (ENGINE COOLANT TEMP) This is not used.

Aftermarket TPS Sensor for Cable driven throttles: (sold separately)

We offer a remote mount TPS sensor. This is typically used on conversions or when the vehicle does not have a factory installed sensor. ATS Diesel Performance has these in stock in case you need one for your specific application.

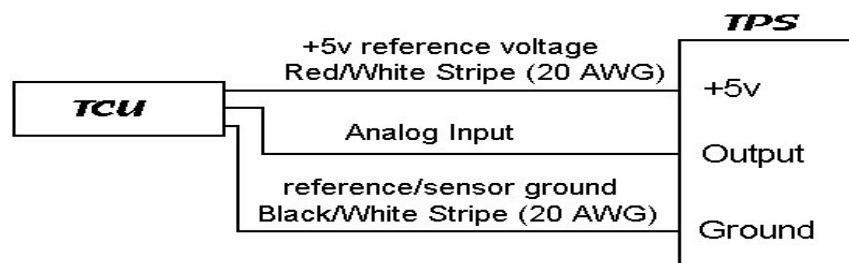

This is wired directly into the TCU controller. Red with White stripe is wired in to the Red with white stripe on the TCU harness. Red with White stripe is a 5V supply can be used for other sensors as well. Black with White stripe is the sensor ground. This is wired in to the Black with White stripe on the TCU harness. The remaining output wire is wired in to the Yellow with White striped wire.

Pressure Transducer:

On our current harness, the pressure sensor we include is plug-and-play. It is used to watch line pressure in the transmission and has no effect on line pressure; it is only used for reference. The Standalone Transmission Controller uses an open loop pressure system.

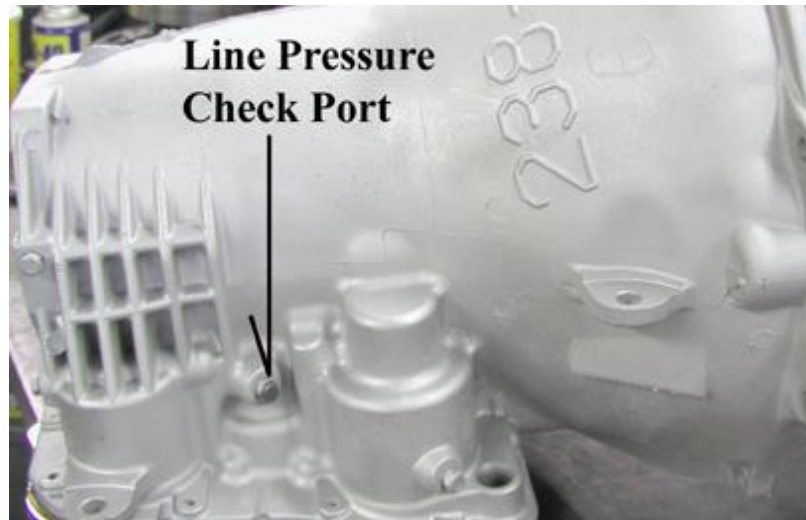

The Standalone Transmission Controller uses a 0-250 psi pressure transducer. This allows the TCU to monitor line pressure. Remove the plug on the side of transmission and insert the 1/8 inch threaded pressure transducer into the case. A fitting may be required to clear the sensor if the exhaust system is in the way.



Speed Inputs, Crank Sensor Signals:

The TCU has four speed inputs which will interpret an incoming signal from a speed sensor. The most important function of speed inputs is to determine driven wheel speed. At least one speed sensor is required to determine driven wheel speed. Additional speed inputs may be used for measuring engine RPM, Turbine speed, driveshaft speed or non-driven wheel speed.

The TCU has been designed to accommodate as many speed sensor types as possible, including both magnetic (2-wire) and hall-effect speed sensors (3-wire).

The only required speed input is driven wheel speed; however the flexibility of the TCU allows even this value to be calculated. To calculate driven wheel speed, you must have drive shaft RPM, driven tire diameter and final drive ratio. Non-driven wheel speed, engine RPM and drive shaft RPM must be measured directly. Torque converter RPM can be directly measured or calculated. You must connect the positive side or output wire of each speed sensor to the respective speed input. If these wires are reversed you may not receive the proper signal. To accommodate a wide range of speed sensor applications, speed input trigger levels and filter values are programmable. This trigger level and filtering programmability helps eliminate false triggering in a noisy environment or no triggering with a low speed or weak signal. Though this parameter can be difficult to understand and deal with, it allows the TCU to accommodate nearly all available sensors.

24-Valve Engine:

ORANGE/ WITH BLACK STRIPE (Tachometer)

This wire is optional. It is used for RPM reference primarily as a gauge in the software.

This is wired in to a crank position sensor **Pin C** which is a **Gray Wire** (pictured below). This wire is used for the factory dash so only share this signal. The signal should be a pulsed 5V signal.

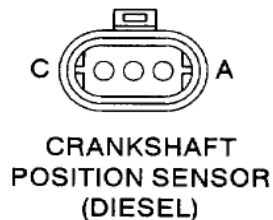

CRANKSHAFT POSITION SENSOR (DIESEL) - 3 WAY		
CAV	CIRCUIT	FUNCTION
A	K6 18VT/WT	5V SUPPLY
B	K14 18BK/DB	SENSOR GROUND
C	K124 18GY	CRANKSHAFT POSITION SENSOR SIGNAL

2003-2013 Common rail Engine 5.9L and 6.7L Cummins:

ORANGE with BLACK STRIPE (Tachometer)

This wire is optional, it is used for RPM reference for a gauge in the software.
Tap into **Pin 3 Brown with Light Blue Stripe Wire** Crankshaft Position Signal.

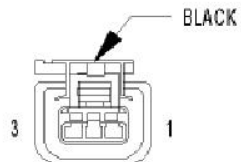

**SENSOR-
CRANKSHAFT
POSITION
(DIESEL)**

SENSOR-CRANKSHAFT POSITION (DIESEL) - BLACK 3 WAY

CAV	CIRCUIT	FUNCTION
1	K853 18DB/BR	5 VOLT SUPPLY
2	K975 18BR/OR	CKP SENSOR GROUND
3	K24 18BR/LB	CKP SIGNAL

- Connector shape and size changes but the pin-out stays the same.

Function	Channel/Calculation	Calibration Value
Engine RPM	Speed 1	# of cylinders: 120.0
Torque Converter RPM	Disabled	Pulses per rev: 0.0
Drive Shaft RPM	Speed 2	Pulses per rev: 23.0
Driven Wheels Speed	Calculated Vehicle Speed	Pulses per rev: 0.0
Non-driven Wheels Speed	Disabled	Pulses per rev: 0.0

Gear Ratios	Max MPH	Enter maximum engine RPM. For max speed calculation purposes only.	Pulses Per Mile
1st: 2.451	0	[] [Press enter]	8050
2nd: 1.451	0	Driven Tire Diameter (in): 33.00 [Help]	Speed Output: Disabled
3rd: 1.000	0	Final drive ratio: 3.729	
4th: 0.690	0	4WD Low ratio: 0.200	

The factory common rail crankshaft trigger wheel has 60 teeth. Being a 4-stroke, the sensor would need to count 120 teeth to see a complete combustion cycle. The above speed input and gearing chart is setup for a common rail 5.9L and 6.7L Cummins with a 60 tooth trigger wheel. Vehicle speed (MPH) is also adjusted here; input vehicle information to get accurate vehicle speed so your shift points will be correct.

Overdrive Cancel:

The overdrive cancel function is very useful for everyday use and is a highly requested feature; therefore, we included instructions on this function. Overdrive cancel forces the transmission to stay in 3rd gear. Once you have perfected your tune you should only need to use this function occasionally. **Digital input 13** is used for overdrive cancel. This input is default set to LOW. A LOW or Grounded switch turns the O/D cancel function on. This can be seen among the other gauges in the monitor display when you have the gauges open.

BROWN/ WITH WHITE STRIPE is overdrive cancel.

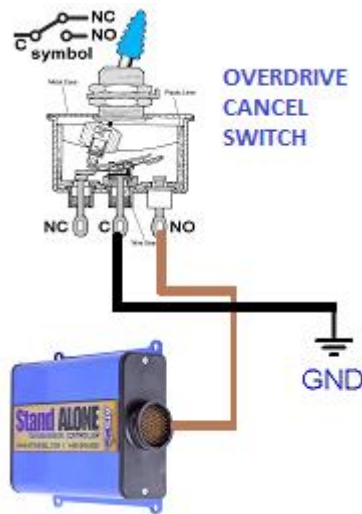

Extra digital Inputs:

These inputs are not normally used, and are not required. They are included and labeled on your harness.

- Trans brake
(Not applicable)
- MLPS
(Not applicable)
- 4 Wheel Low

The 4 Wheel Low Range signal wire is not required because the 47RE and the 48RE have their output speed sensor located on the back of the transmission, before the transfer case. Normally this is for other 4WD applications, where the output speed sensor is on the back of the transfer case. This way the transmission can compensate for the speed difference, and still deliver proper shift timing and normal drivability in low range.

Software

Line Pressure Adjustment “TPS Based”

Line pressure is preset to a good baseline; however, not every transmission is identical. We recommend monitoring and adjusting line pressure to make sure it does not fall too low (less than 110 psi) and to suit your needs. We recommend running the highest line pressure possible without binding up the shifts if you are making high amounts of power. Most shifts should happen at about 150-225 psi. The maximum pressure the transducer can read is 250 PSI, but keep in mind that pressure could be as high as 300 psi. The diagrams below is a good starting point for pressure, but after a fresh install always look at the actual pressure in the monitor. We recommend making small changes at first, very small changes on this table will have a noticeable effect.

RECOMMENDED LINE PRESSURE TABLE “TPS BASED”

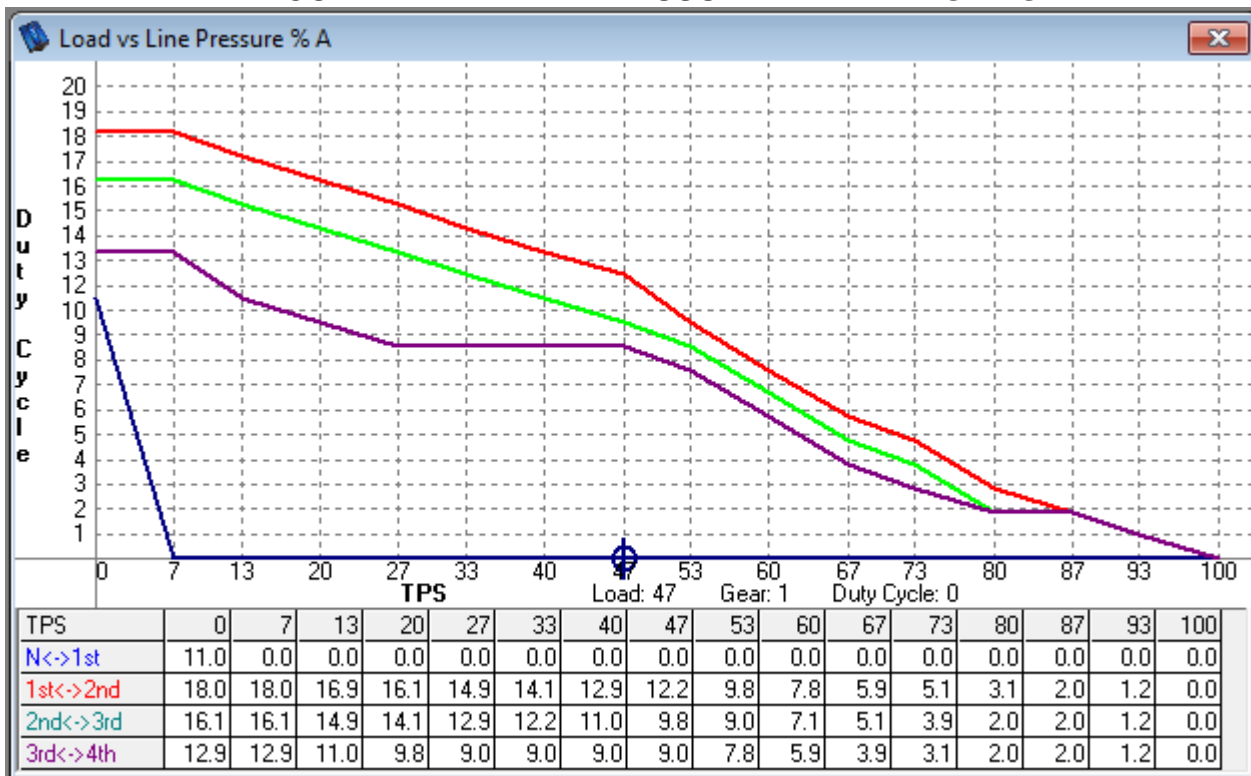

Keep in mind that we use a **normally open (NO) solenoid** for line pressure control. This means duty cycle is used to bring pressures down. **0 duty cycle is full line pressure** and **40 duty cycle is very low line pressure**. By bringing down the duty cycle the line pressure is increased.

BE CAREFUL

Line pressure too low will slip clutches, & too high of line pressure can reduce cooler flow causing transmission overheating.

Line Pressure Adjustment “MAP Based”

Line pressure is preset to a good baseline. Because not every transmission is identical, we recommend monitoring line pressure to make sure it does not fall too low (less than 110 PSI) under light load. We recommend running the highest line pressure possible without binding up the shifts. Most shifts should happen at about 190-250 PSI. The maximum pressure the transducer can read is 250 PSI but keep in mind that pressure could be as high as 300 PSI if the pump and drive it that high. The diagram below is just a good starting point for pressure; however, always look at the actual pressure in the monitor. We recommend making small changes. Very small changes on this table will affect a lot.

Pressure should run 110 PSI at low load in 2nd – 4th. Pressure should run 175 to 240 under heavy load. Pressure will read slightly lower in 4th, this is normal. Try to run 150 psi or higher under load. If clutches bind up, drop pressure a little at a time until the desired shift is achieved. Also check band adjustment (mentioned later in the instructions) Pressure in 1st should be driven to 250 PSI or higher.

Check to make sure pressures only read when the transmission is in drive!

RECOMMENDED LINE PRESSURE TABLE “MAP BASED”

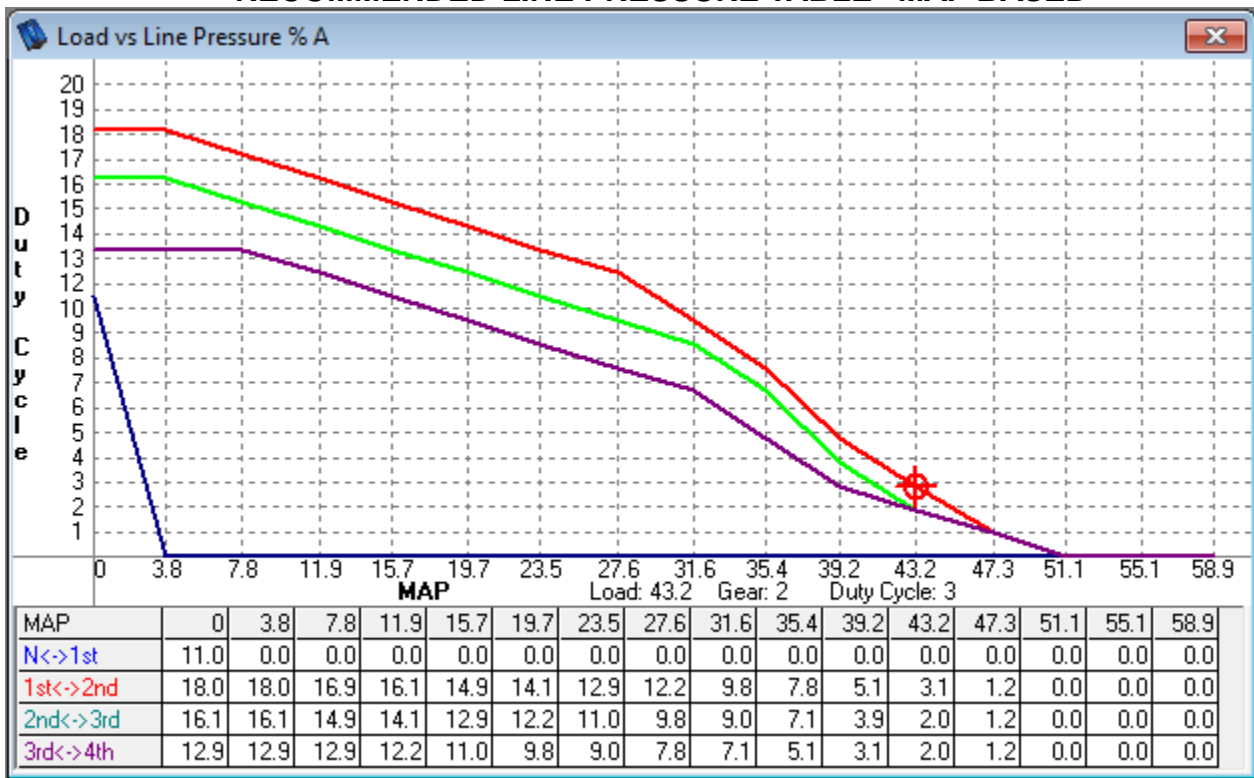

Keep in mind that we use a **normally open (NO) solenoid** for line pressure control. This means duty cycle is used to bring pressures down. **0 duty cycle is full line pressure** and **25 duty cycle is very low line pressure**. **By bringing down the duty cycle the line pressure is increased.** **BE CAREFUL**, line pressure too low will slip clutches. Too high of line pressure can reduce cooler flow causing transmission overheating. Pressure should run 110 PSI to 195 under load. In some cases it may be ok to run even higher pressures.

Torque Converter Clutch Lockup Control

In the **TCC Lockup Parameters A** menu we typically enter the values shown below:

Enter the “2” in the “**Lowest gear to allow TCC lockup**” field to allow lockup in 2nd gear. In the 47 and 48 transmission we can lock in 1st, 2nd, 3rd and 4th. 1st gear can be used for torque converter lockup; however, 2nd is preset by default for better drivability and to prevent engine stalling.

Enter “-58” in the “**Don’t lock TCC when engine is below this temp.**” field. Engine temperature is not used as an input so setting it to any other temperature will not affect lockup.

Enter “392” in the “**Keep TCC locked above this fluid temp.**” This can be used to limit fluid temperatures by keeping the TCC locked in. We don’t currently use this function but it can be adjusted as desired.

Enter “-58” in the “**Don’t lock TCC below this fluid temp.**” field. To help the transmission warm up, you can select a higher temperature if desired.

TCC lockup may be selected per gear or for all gears (normal). TCC lockup per gear provides a different TCC lockup and unlock curve for each gear. Normal TCC lockup provides a single TCC lockup and unlock curve that is not gear related. Most users should select normal TCC lockup. TCC lockup per gear should only be used by advanced users and for installations requiring this complexity. The TCC can be unlocked during up-shifts and downshifts to provide smoother shifting and reduce unnecessary impact loading on the drive-train.

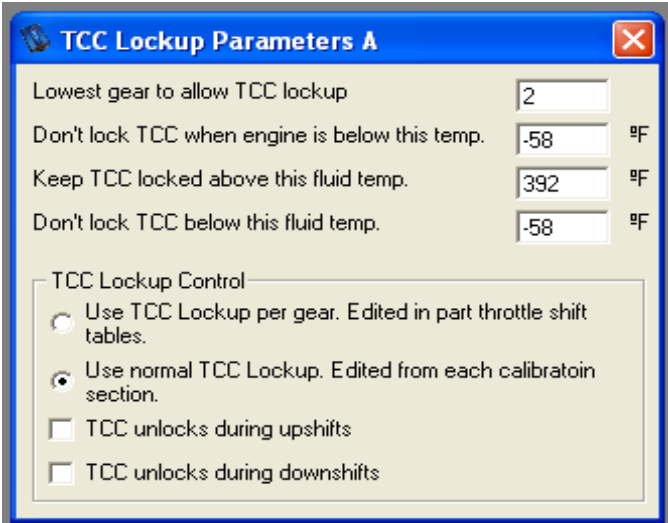

The screenshot shows a software window titled "TCC Lockup Parameters A" with a close button in the top right corner. The window contains four input fields for temperature and gear settings, and a section for TCC Lockup Control with four radio and checkbox options.

Parameter	Value	Unit
Lowest gear to allow TCC lockup	2	
Don't lock TCC when engine is below this temp.	-58	°F
Keep TCC locked above this fluid temp.	392	°F
Don't lock TCC below this fluid temp.	-58	°F

TCC Lockup Control

- Use TCC Lockup per gear. Edited in part throttle shift tables.
- Use normal TCC Lockup. Edited from each calibratoin section.
- TCC unlocks during upshifts
- TCC unlocks during downshifts

TCC Lockup/ Unlock Table “TPS Based”

With this table lockup can be adjusted based on TPS vs. MPH.

The **BLUE** line is the TCC lockup curve. It controls the conditions when the TCC will lock under acceleration.

The **RED** line is the TCC unlock curve. It controls when the torque converter will unlock after lockup occurs.

Both the lock and unlock curves are fully tunable to suit your vehicle and driving style. Always keep adequate room between the lockup and unlock curves. If they are too close, the converter can go in and out of lockup erratically.

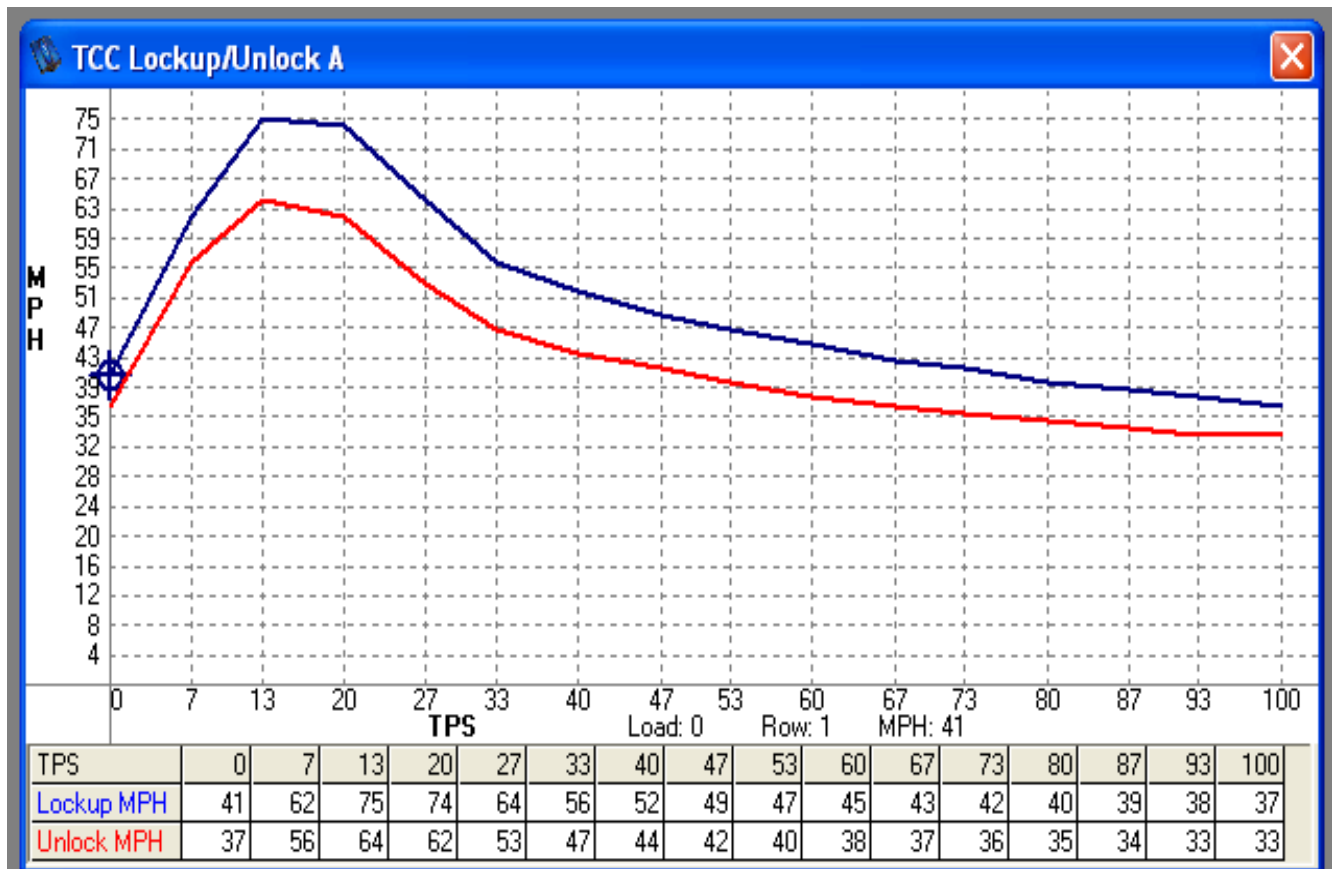

TPS Based Lockup tips:

The converter tune will differ on every truck. A larger single turbo may have more lag, so the lockup must be brought to a higher speed for good drivability. If it feels like engine has plenty of power you can lower the lockup speed. We recommend using MAP based lockup for a larger turbo as well as better drivability on any turbo application. TPS based lockup is designed for vehicles without a map sensor.

TCC Lockup/ Unlock Table “MAP Based” (recommended)

With this table lockup can be adjusted based on MAP vs. MPH.

The **BLUE** line is the TCC lockup curve. It controls the conditions when the TCC will lock under acceleration.

The **RED** line is the TCC unlock curve. It controls when the torque converter will unlock after lockup occurs.

Both the red and blue curves are fully tunable to suit your vehicle and driving style. Always keep adequate room between the lockup and unlock curves, if they are too close, the converter can go in and out of lockup erratically. The lock and unlock set points are also spread farther apart under load or boost, this helps prevent the turbo from huffing.

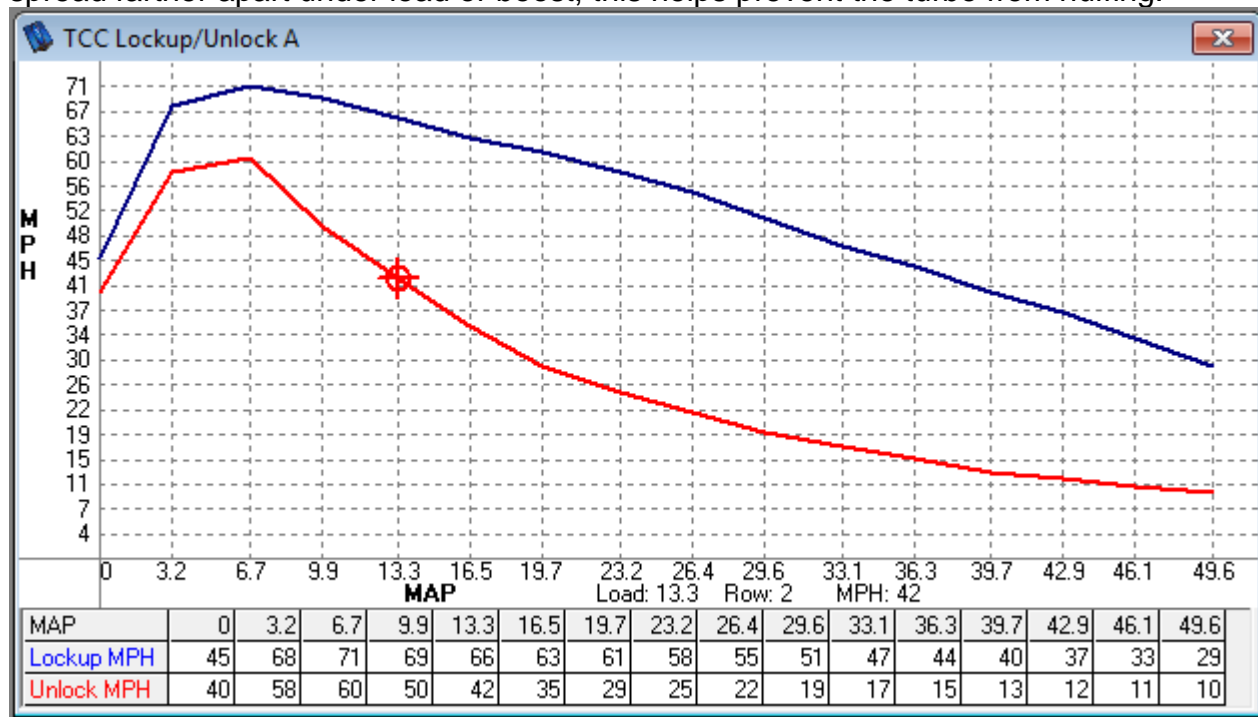

MAP Based Lockup Tips:

The converter tune will differ on every truck, and will need to be adjusted. A larger single turbo may have more lag, so the lockup must be brought to a higher speed for good drivability, as seen in the example above. With MAP based lockup your turbo will have outstanding performance once it is dialed in. The lockup point can be adjusted to complement your turbo setup. For example if the converter surges on acceleration the lockup speed or boost level of lockup can be adjusted to a higher level. If the turbo is making plenty of boost at lower speeds, it can be locked earlier resulting in less power loss through torque converter slip. The converter can be used for an engine brake and/or as a way of helping your turbo to stay spooled on deceleration. By allowing the engine to be loaded, more energy is traveling out the exhaust, keeping your turbo spooled. Also notice above how the converter unlock happens at 4-8 psi this helps to eliminate throttle tip in turbo lag. It will need to be adjusted to your setup.

Adjusting TCC Application Time

The TCC Pressure Control does not normally need to be adjusted. It is preset to a good default level. However, application time can be adjusted. Something to know, the torque converter is an on/off type circuit, meaning that it does not work well doing a gradual application. Too long of an application time and the converter lockup clutches will get hurt. **These adjustments should only be adjusted by experienced users and after lockup mph tables are tuned.**

Lockup Starting Duty Cycle%

This should always be set about 25% duty cycle. Too high of a duty cycle can cause the converter to apply on too quickly causing a firm lockup. Setting too low of an application time and the converter will slip.

Lockup Ending Duty Cycle%

This can be anywhere from 88% to 100% duty cycle. Default we leave this at 100%. Too low and the converter will not lockup or will slip the converter.

Lockup Rate (% per second)

This is can be adjusted to speed up or slow down lockup apply time. For example, 100% equates to 1 second when starting from 25% to ending duty cycle. 67% is about 1.116 seconds to go from 25% to 100%. Keep in mind the solenoid will start to apply lockup at about 70% duty cycle then it needs to change the flow in the converter so it can lockup. The pump in the transmission is responsible for most of the lockup time as well as the size of the torque converter. This can take up to 2 seconds to apply lockup after the TCC light turns on in the software monitor.

(Lockup Rate% / 60 = Solenoid Apply Seconds)

(Solenoid Apply Seconds + ~1 = TCC Apply Seconds)

Unlock rates

These do not need to be adjusted. For reference of what is a good unlock rate look below.

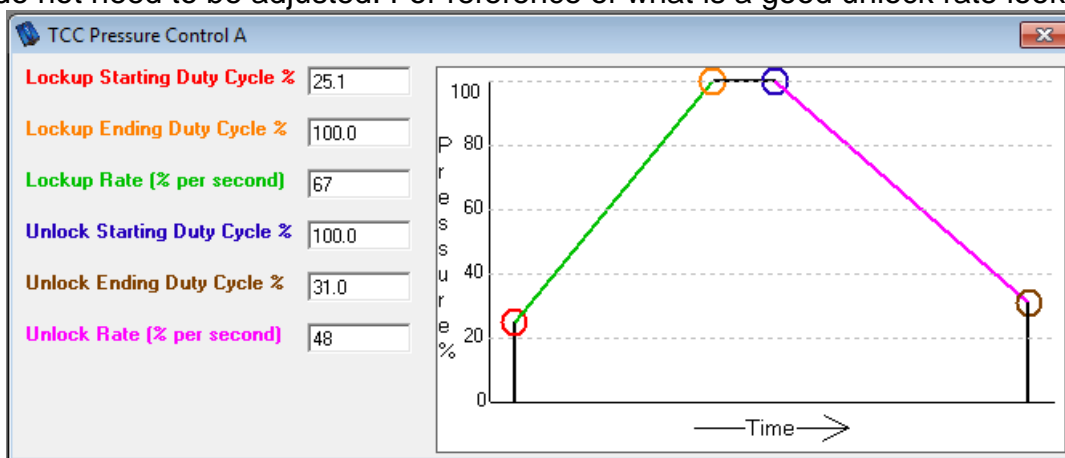

Adjusting Downshifts and Upshifts

The **Upshift/Downshift Tables** Controls when the vehicle changes gear. The diagram below provides a good example of a 1 & 2 shift table.

The **BLUE** line is the 1-2 upshift curve. The transmission will not upshift until it satisfies the conditions set in the table.

The **RED** line is the 2-1 downshift curve. The transmission will not downshift until vehicle speed and throttle percent drop below the curve.

BE CAREFUL: Do not to exceed the maximum engine rpm with the speed values. The speed input/output form has a speed calculator based on engine rpm, gearing, final drive ratio and tire size which can help you match this chart with the WOT settings.

Always keep adequate room between the up shift table and downshift table. If you do not, your transmission may hunt for gears and shift too often or shift when it shouldn't.

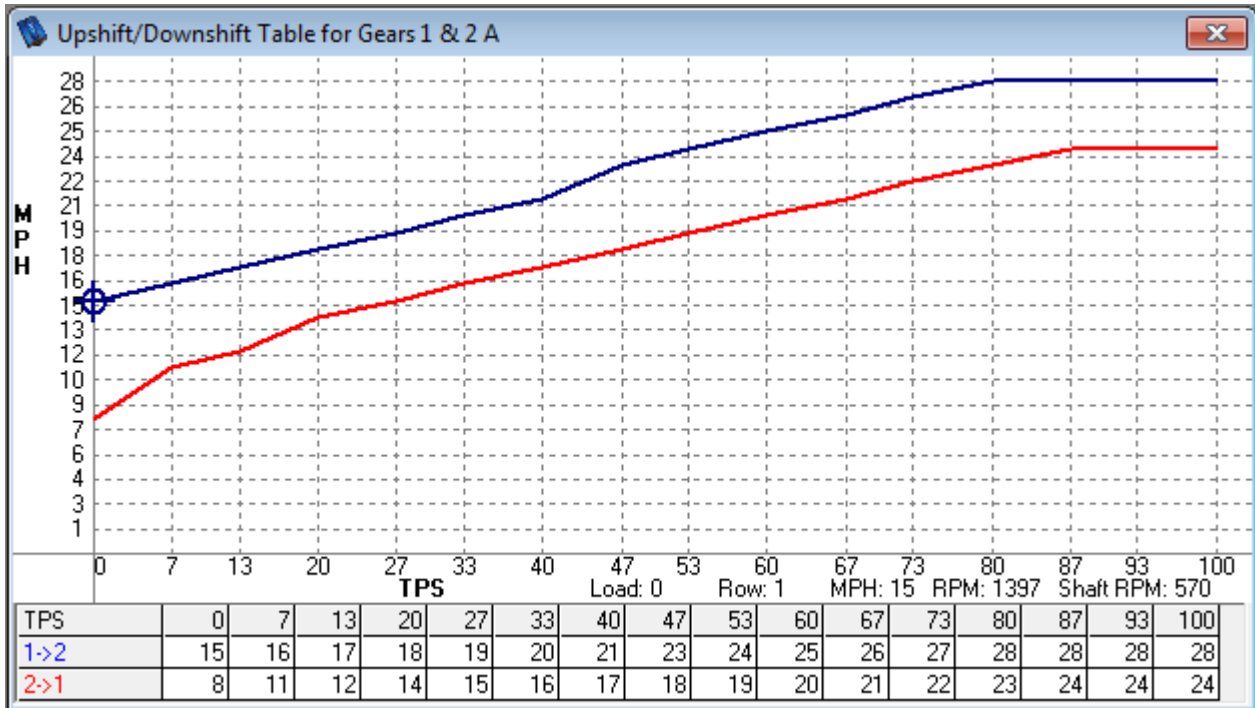

Shift Points

Shift points can be adjusted at any time. Each line represents a downshift or upshift curve and they are color coded for quick recognition. A green dot will indicate the TPS to MPH helping identify ways to improve shift points.

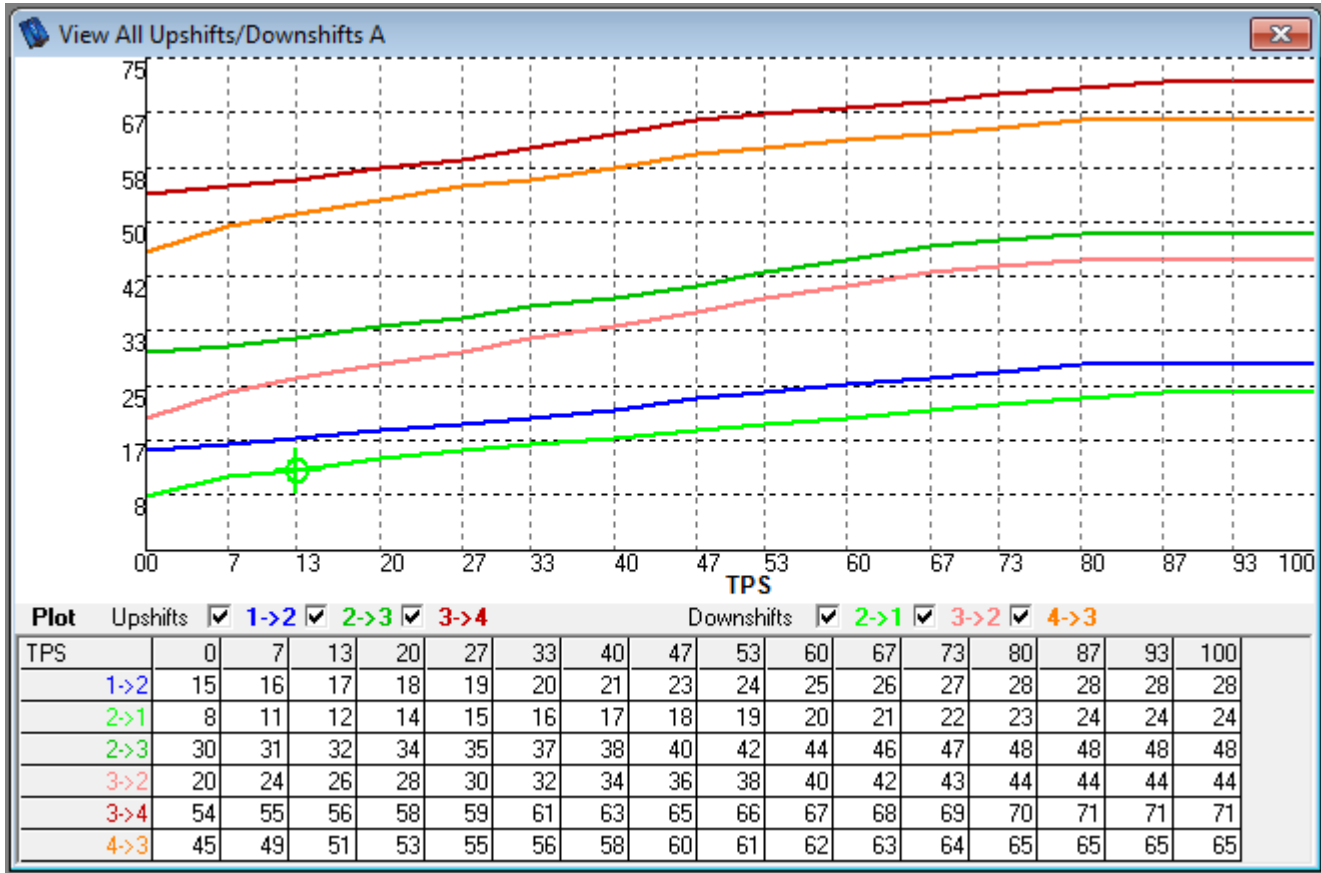

The up shift/downshift table parameters shown above are a base starting point for most applications. In this view, you can adjust the upshifts/downshifts and see where you are in the table (very useful when tuning on the fly). Shift points will always need to be adjusted on every vehicle. As no one vehicle is fueled or built in the same way. Shift points will need to be adjusted to complement your setup. A larger single turbo will need a much higher shift point in each gear to keep the turbo lit for the next gear.

The 4th gear ratio is much higher than 3rd so the spread between shifts will always be a little higher when shifting in to 4th.

Notice that on deceleration 0 - 7 TPS % the down shifts are 3 to 5 mph lower. This is to give a smoother down shift on deceleration.

Always keep adequate room between the up shift table and downshift table. If you do not, your transmission may hunt for gears and shift too often or shift when it shouldn't.

Load vs. Accumulator Pressure Table

We recommend leaving this table at 0 because an accumulator is not used.

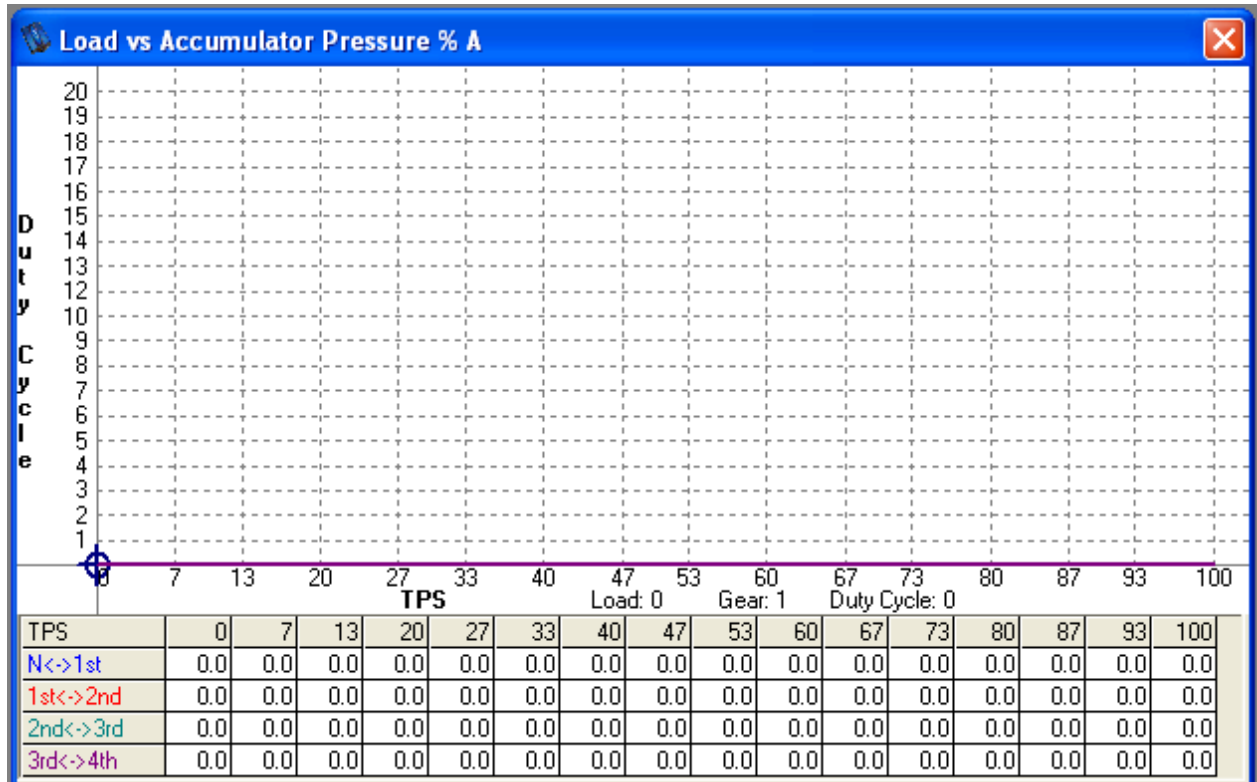

Wide Open Throttle Settings A

If you wired in the crank signal, this can be used as a safety feature. This table overrides the shift point table. Make sure this table is correct before adjusting shift points.

WOT Upshift RPM 1st Gear	4841	WOT Downshift MPH 2nd Gear	38
WOT Upshift RPM 2nd Gear	4851	WOT Downshift MPH 3rd Gear	64
WOT Upshift RPM 3rd Gear	4862	WOT Downshift MPH 4th Gear	92

Breakpoints and Configuration:

The screenshot shows a software window titled "Breakpoints and Configuration". It contains a table with 17 columns and 6 rows of data. Below the table are four radio button groups for "Part Throttle Shift Table", "Line Pressure", "Accumulator Pressure", and "Torque Converter Lock Up", each with "TPS" and "MAP" options. A "MAP/MAF Selection" section has "Use MAP" selected. Two dropdown menus for "Fluid Temperature 1" are also present.

RPM	0	333	667	1000	1333	1667	2000	2333	2667	3000	3333	3667	4000	4333	4667	5000
TPS	0	7	13	20	27	33	40	47	53	60	67	73	80	87	93	100
MPH	0	8	16	24	32	40	48	56	64	72	80	88	96	104	112	120
MAP/MAF	0	3.2	6.7	9.9	13.3	16.5	19.7	23.2	26.4	29.6	33.1	36.3	39.7	42.9	46.1	49.6
Temp (°F)	-51	-26	-2	21	46	70	93	118	142	165	190	214	237	262	286	309

Part Throttle Shift Table
 TPS MAP

Line Pressure
 TPS MAP

Accumulator Pressure
 TPS MAP

Torque Converter Lock Up
 TPS MAP

MAP/MAF Selection
 Use MAP Use MAF

If you change an above TPS/MAP/MAF selector for a window you have open you will need to close and reopen that window before continuing to work on it. After changing the MAP/MAF Selection you will need to close and re-open this form as well as any other windows you have open that are using MAP or MAF breakpoints.

Temperature based line pressure trims should be based off of this temperature reading: Fluid Temperature 1

Temperature based up and downshift trims should be based off of this temperature reading: Fluid Temperature 1

This is where line pressure and torque converter lockup can be set to TPS or MAP based tables.

Torque Converter Lock Up
 TPS MAP

MAP based is recommended requires a map sensor which will need to calibrated in. TPS is set default because not every truck has a MAP sensor. (12 valve).

Line Pressure
 TPS MAP

If you change a TPS or MAP selection for a window you will have to close and reopen that window before continuing to work on it.

Adjusting Table axis's:

The 5.9L Dodge factory Map sensor is 0 – 50 PSI and it is the pre-set value.
 The 6.7 L Dodge has a 0 - 40 psi Map sensor so the table below should be adjusted accordingly.

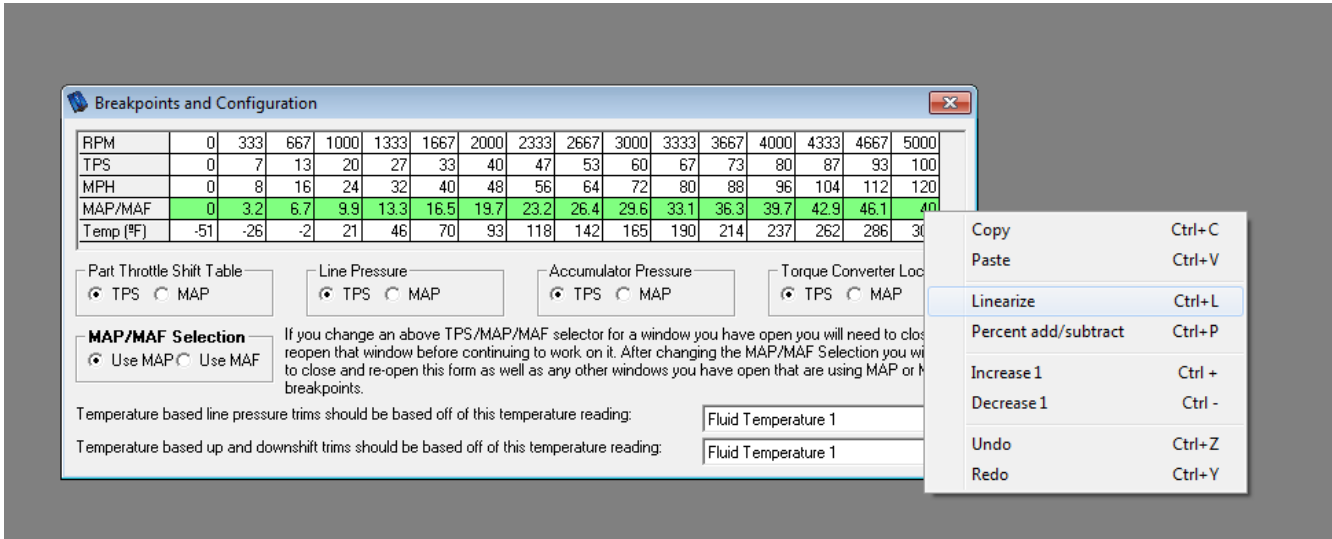

We recommend at least a 40 PSI to a 59 PSI sensor if the axis is going to be MAP based. Using the linearize function will help dial in your axis adjustments faster as seen above. This is done by changing the end value number and selecting the whole row and right clicking, then select linearize.

The table below is the axis adjustment labeling for your adjustment tables. Make sure that it is set correctly for your vehicle.

RPM	0	333	667	1000	1333	1667	2000	2333	2667	3000	3333	3667	4000	4333	4667	5000
TPS	0	7	13	20	27	33	40	47	53	60	67	73	80	87	93	100
MPH	0	8	16	24	32	40	48	56	64	72	80	88	96	104	112	120
MAP/MAF	0	3.2	6.7	9.9	13.3	16.5	19.7	23.2	26.4	29.6	33.1	36.3	39.7	42.9	46.1	49.6
Temp (°F)	-51	-26	-2	21	46	70	93	118	142	165	190	214	237	262	286	309

If you have an aftermarket 0-60 PSI sensor the following table is a good example.

RPM	0	333	667	1000	1333	1667	2000	2333	2667	3000	3333	3667	4000	4333	4667	5000
TPS	0	7	13	20	27	33	40	47	53	60	67	73	80	87	93	100
MPH	0	8	16	24	32	40	48	56	64	72	80	88	96	104	112	120
MAP/MAF	0	3.9	7.9	11.8	15.7	19.7	23.6	27.5	31.5	35.4	39.3	43.3	47.2	51.1	55.1	59
Temp (°F)	-51	-26	-2	21	46	70	93	118	142	165	190	214	237	262	286	309

Adjusting Analog Inputs:

All the standalone analog inputs are 0-5 volt analog signals.

For example the following table is the 6.7L Dodge Map sensor scaled in.

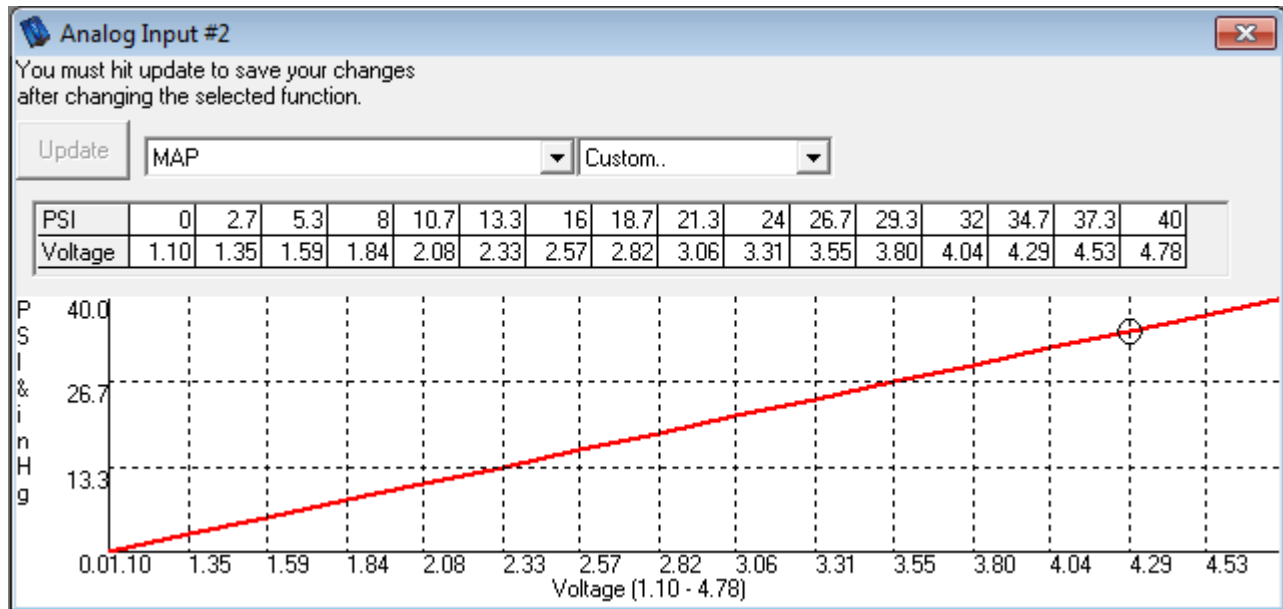

Typically we run the TPS as input 1, MAP sensor on analog input 2, line pressure sensor input 3, input 4 is normally open, transmission fluid temp is input 5, and input 6 is open. The extra analog inputs are open for further options which are not required.

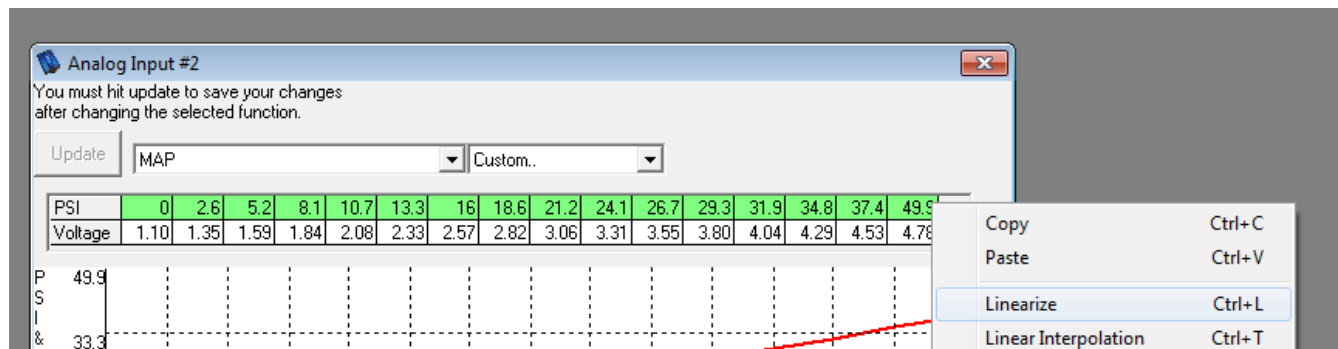

The linearize function will help dial in your MAP scaling faster as seen above. This is done by changing the end value number and selecting the whole row and right clicking. Then select linearize.

Digital Inputs:

Most of the digital inputs are completely optional, but digital inputs can be very useful. The digital inputs can be referred to in the diagram below.

Channel	Function	Active Low or High	Button Type	Reverse Logic
1	Dyno Mode	High <input type="radio"/> Low <input checked="" type="radio"/>	Momentary <input type="radio"/> Toggle <input checked="" type="radio"/>	<input type="checkbox"/>
2	Disabled	High <input checked="" type="radio"/> Low <input type="radio"/>	Momentary <input type="radio"/> Toggle <input checked="" type="radio"/>	<input type="checkbox"/>
3	Disabled	High <input checked="" type="radio"/> Low <input type="radio"/>	Momentary <input type="radio"/> Toggle <input checked="" type="radio"/>	<input type="checkbox"/>
4	Disabled	High <input checked="" type="radio"/> Low <input type="radio"/>	Momentary <input checked="" type="radio"/> Toggle <input type="radio"/>	<input type="checkbox"/>
5	Disabled	High <input checked="" type="radio"/> Low <input type="radio"/>	Momentary <input type="radio"/> Toggle <input checked="" type="radio"/>	<input type="checkbox"/>
6	Disabled	High <input checked="" type="radio"/> Low <input type="radio"/>	Momentary <input type="radio"/> Toggle <input checked="" type="radio"/>	<input type="checkbox"/>
7	Disabled	High <input checked="" type="radio"/> Low <input type="radio"/>	Momentary <input type="radio"/> Toggle <input checked="" type="radio"/>	<input type="checkbox"/>
8	Disabled	High <input checked="" type="radio"/> Low <input type="radio"/>	Momentary <input type="radio"/> Toggle <input checked="" type="radio"/>	<input type="checkbox"/>
9	Disabled	High <input type="radio"/> Low <input checked="" type="radio"/>	Momentary <input type="radio"/> Toggle <input checked="" type="radio"/>	<input type="checkbox"/>
10	Disabled	High <input checked="" type="radio"/> Low <input type="radio"/>	Momentary <input type="radio"/> Toggle <input checked="" type="radio"/>	<input type="checkbox"/>
11	Disabled	High <input type="radio"/> Low <input checked="" type="radio"/>	Momentary <input type="radio"/> Toggle <input checked="" type="radio"/>	<input type="checkbox"/>
12	Disabled	High <input type="radio"/> Low <input checked="" type="radio"/>	Momentary <input type="radio"/> Toggle <input checked="" type="radio"/>	<input type="checkbox"/>
13	Cancel Overdrive	High <input type="radio"/> Low <input checked="" type="radio"/>	Momentary <input checked="" type="radio"/> Toggle <input type="radio"/>	<input type="checkbox"/>
14	Disabled	High <input checked="" type="radio"/> Low <input type="radio"/>	Momentary <input type="radio"/> Toggle <input checked="" type="radio"/>	<input type="checkbox"/>
15	Disabled	High <input checked="" type="radio"/> Low <input type="radio"/>	Momentary <input type="radio"/> Toggle <input checked="" type="radio"/>	<input type="checkbox"/>
16	Disabled	High <input checked="" type="radio"/> Low <input type="radio"/>	Momentary <input type="radio"/> Toggle <input checked="" type="radio"/>	<input checked="" type="checkbox"/>

Digital Debounce: 98 ms Reset Digital Input Settings

Digital Input	Wire Color
1	GRY/BLK
2	GRY/RED
3	GRY/LT.GREEN
4	GRY/BLUE
5	GRY/WHT
6	GRY/ORN
7	GRY/PNK
8	GRY/YEL
9	BRN/BLK
10	BRN/RED
11	BRN/LT.GRN
12	BRN/LT.BLU
14	BRN/ORN
15	BRN/YEL

Active high or low is referring to the signal if it is high which would be 5 -14 volts. Or low which would be grounded. Digital inputs only read high or low. If the switch works backwards then the logic reverse needs to be selected.

Data Logging

The TCU has a data logging feature. This is a very useful part of the standalone TCU. This can be used to review previous runs. You must start the data log in order to record the run.

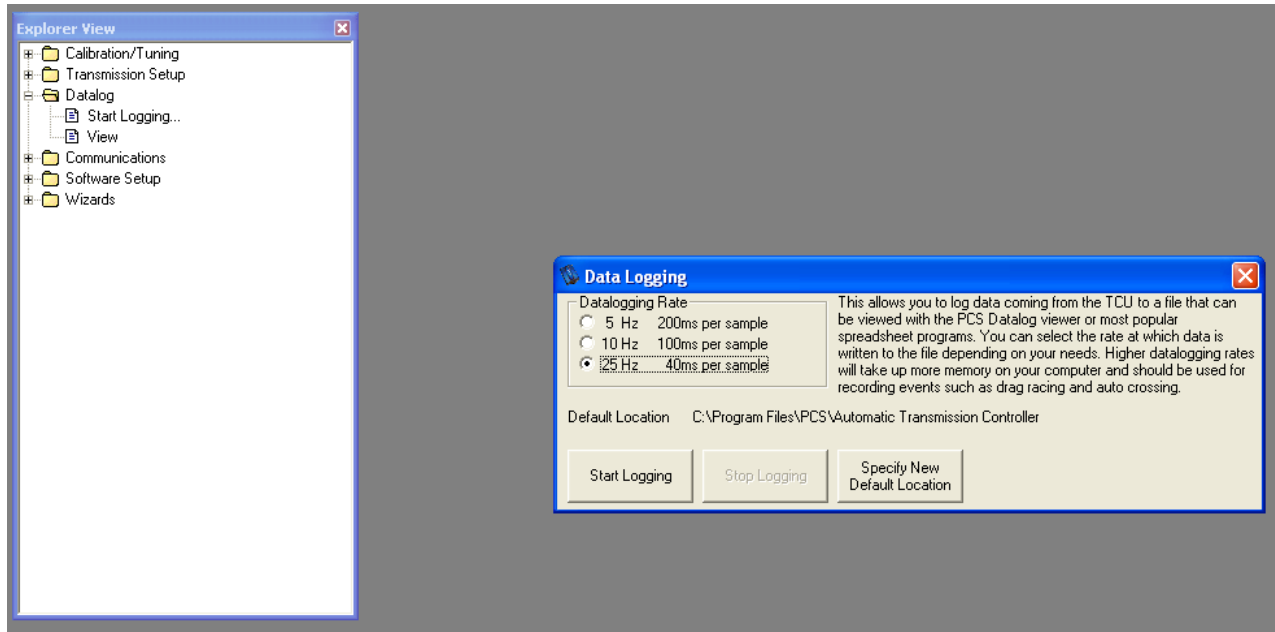

To launch the data log viewer, press the “View” icon in the “Datalog” folder.

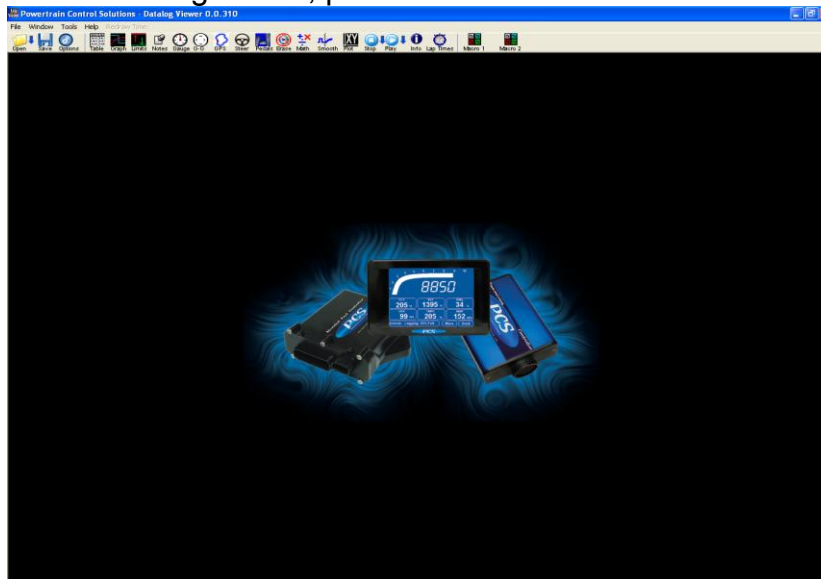

Monitor Screen

This can be used to watch all inputs and outputs including TCC lockup, current gear, vehicle speed, RPM, TPS and much more.

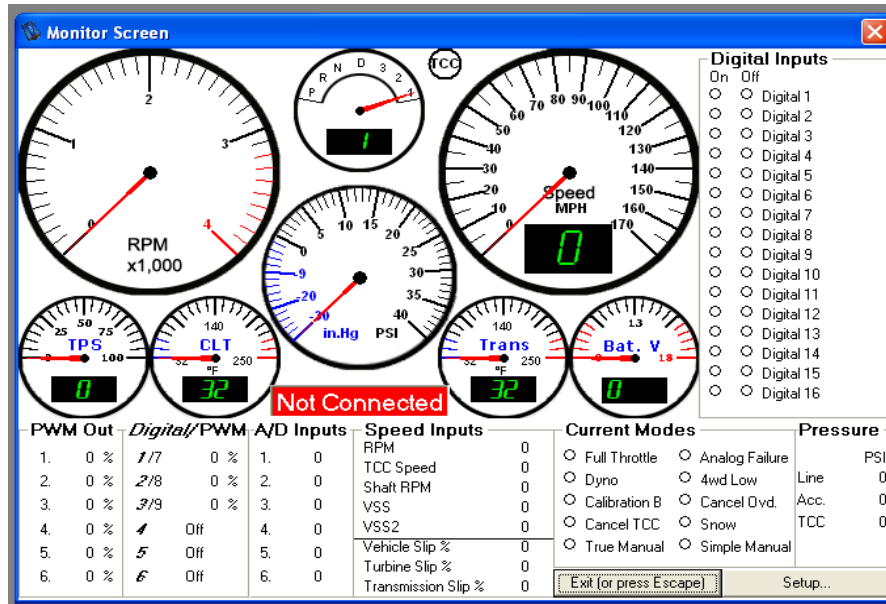

Watching pressure:

Watching pressure is a very important part of the monitor function. Pressure is found on the right hand side of the screen. Pressure will only read accurately when in drive position because of the hydraulic circuit. Pressure should average 145 - 165 psi and run as high as 250 psi at wide open throttle. When Idling in drive pressure will typically it will run at 115 – 125 psi.

Verifying TPS:

Throttle position is shown on a gauge on the far left. Before starting the truck you can make sure your TPS is reading accurately. If it is not, it may need to be rescaled.

Verifying MPH:

Because of tire size changes and gear ratio changes, your vehicle speed may not read accurately. MPH can be viewed here. Speed should be checked against the factory speedometer or a GPS. This can also be adjusted in the TCU software.

Watch RPM:

The engine RPM is not required but it is useful. It can be watched here.

HELPFUL HINT: All inputs and outputs can be watched from the monitor screen. It can be used to diagnose any issues.

Speed Inputs/ Gearing Chart:

Function		Channel/Calculation	Calibration Value
Engine RPM		Speed 1	# of cylinders 116.0
Torque Converter RPM		Disabled	Pulses per rev 0.0
Drive Shaft RPM		Speed 2	Pulses per rev 23.0
Driven Wheels Speed		Calculated Vehicle Speed	Pulses per rev 0.0
Non-driven Wheels Speed		Disabled	Pulses per rev 0.0
Gear Ratios	Max MPH	Enter maximum engine RPM. For max speed calculation purposes only.	Pulses Per Mile
1st	2.451 38	3500 [Press enter]	8050
2nd	1.451 63	Driven Tire Diameter (in)	Speed Output
3rd	1.000 92	33.00 Help	Disabled
4th	0.690 134	Final drive ratio 4WD Low ratio	
		3.729 2.200	

Make sure that your monitor reads MPH correctly. Adjust until the speed on your monitor matches your factory dash. Changing your Driven Tire Diameter will change your speed reading to your select shift standalone. If you have re-gearred your differentials it would help to get your gear ratio set here as well.

Speed Calculator:

It may be helpful to use this rpm calculator to see what MPH the transmission will shift at. Keep in mind it takes time to shift, so adjust your shift points a MPH 1 to 2 mph lower than the calculator. The computer will be close but not perfect.

Gear Ratios	Max MPH	Enter maximum engine RPM. For max speed calculation purposes only.
1st	2.451 38	3500 [Press enter]
2nd	1.451 63	Driven Tire Diameter (in)
3rd	1.000 92	33.00 Help
4th	0.690 134	Final drive ratio 4WD Low ratio
		3.729 2.200

Setting up Unit types:

By default the Select Shift Software settings are set up mostly in standard. However MAP will most likely be most understood if turned to PSI.

Monitor setup:

The image shows two overlapping windows from a software interface. The 'Unit Configuration' window on the left has three sections: 'Temperature' with radio buttons for °C and °F (°F is selected), 'MAP' with radio buttons for kPa and PSI/in.Hg (PSI/in.Hg is selected), and 'Speed' with radio buttons for KPH and MPH (MPH is selected). Below these are 'Metric' and 'Standard' buttons. A note at the bottom states: 'After changing these units you will need to reload any open forms that use them in order to see a change.' The 'Monitor Setup' window on the right is divided into three sections: 'RPM' with 'Max RPM' (35 x 1000) and 'Redline RPM' (5 x 1000) fields, and a 'Breakpoint marks per 1000 RPM' field (10); 'Speed' with 'Max Speed' (200 MPH) and 'Index mark every' (10 MPH) fields, and a 'Breakpoint marks per index mark' field (2); and 'MAP' with 'Max MAP' (55 PSI) and 'Index mark every' (10 PSI) fields, and a 'Breakpoint marks per index mark' field (5). At the bottom are 'Units...' and 'Apply' buttons.

Password Protected tunes:

The image shows a 'Setup Password Protection' dialog box. It has two input fields: 'Set Password' and 'Retype Password'. Below the fields is a note: 'Note: Passwords have a maximum length of 16 characters and may not contain spaces. After setting a password the unit must be restarted for the changes to take effect. Passwords ARE case sensitive.' At the bottom are two buttons: 'Set' and 'Erase Unit Password'.

The base tune we supply has no password protection. You can password protect any tune you develop.

Dyno Mode:

Dyno mode is a very useful tool. It can help prevent the converter from unlocking during your run as well as up shifting and down shifting.

This is tuned in the software as below.

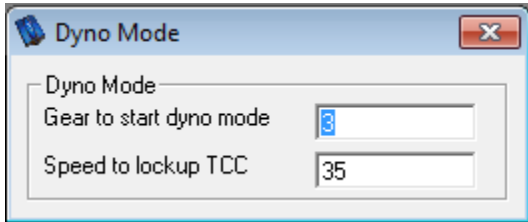

4th gear ratio is 0.69 : 1

3rd gear ratio is 1 : 1

2nd gear ratio is 1.45 : 1

1st gear ratio is 2.45 : 1

This can be enabled in the software at the dyno or by a digital input. Page 29 references digital inputs as well as page 35.

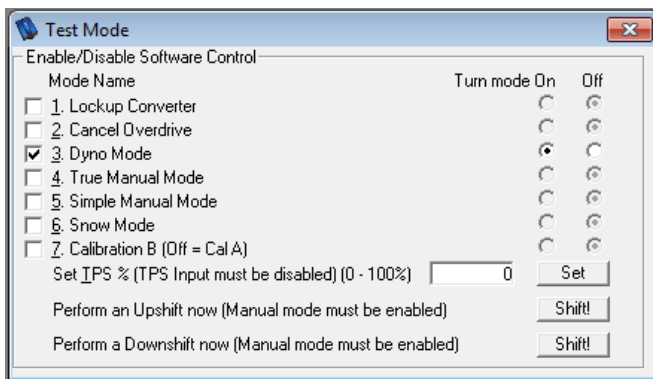
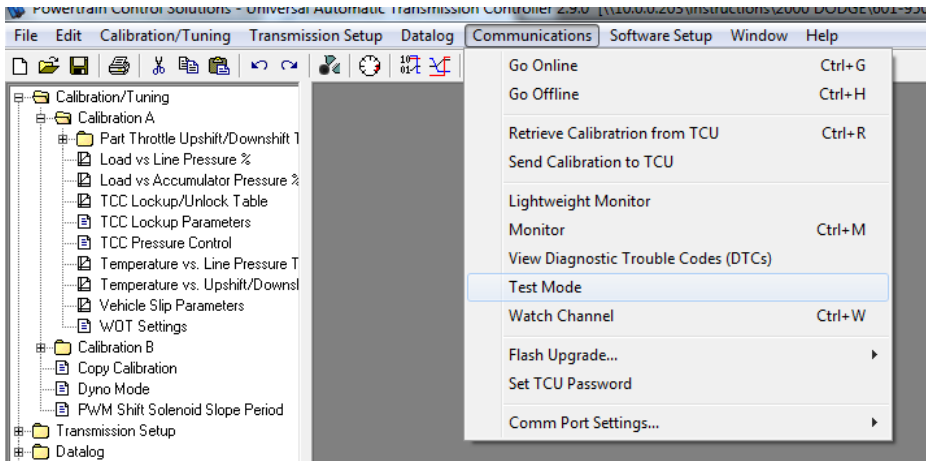

*Dyno Mode is shown above and is turned on.

Calibration B:

When enabled, this allows a second full calibration to be used. This can be especially useful for the occasion racing, towing, fuel economy, etc. You will need to fully tune this calibration before using. It is not recommended to use calibration B until calibration A is perfect. A copy calibration function is available in the tuning menu, which can greatly speed up the process. Switching this can be done on the fly while driving.

Calibration A is default.

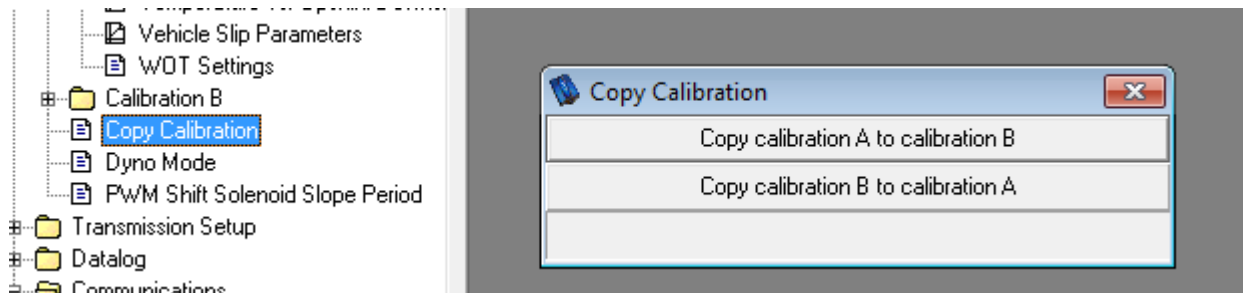

This can be wired in as a digital input as well.

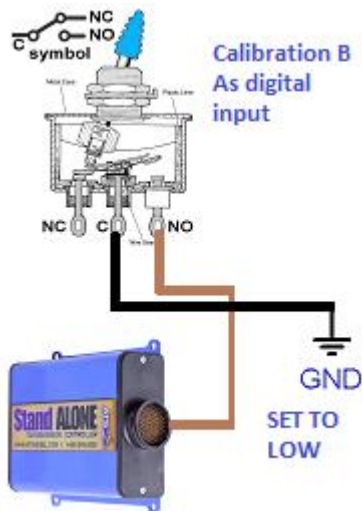

If wired as above set setting as below.

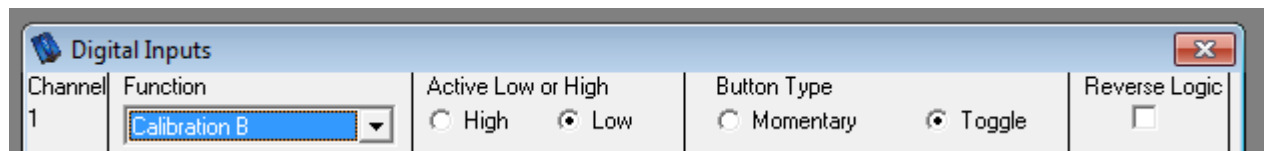

Calibrating the TPS Sensor

To calibrate the TPS voltage wired in earlier, use the “TPS Wizard” in the “Wizards” folder.

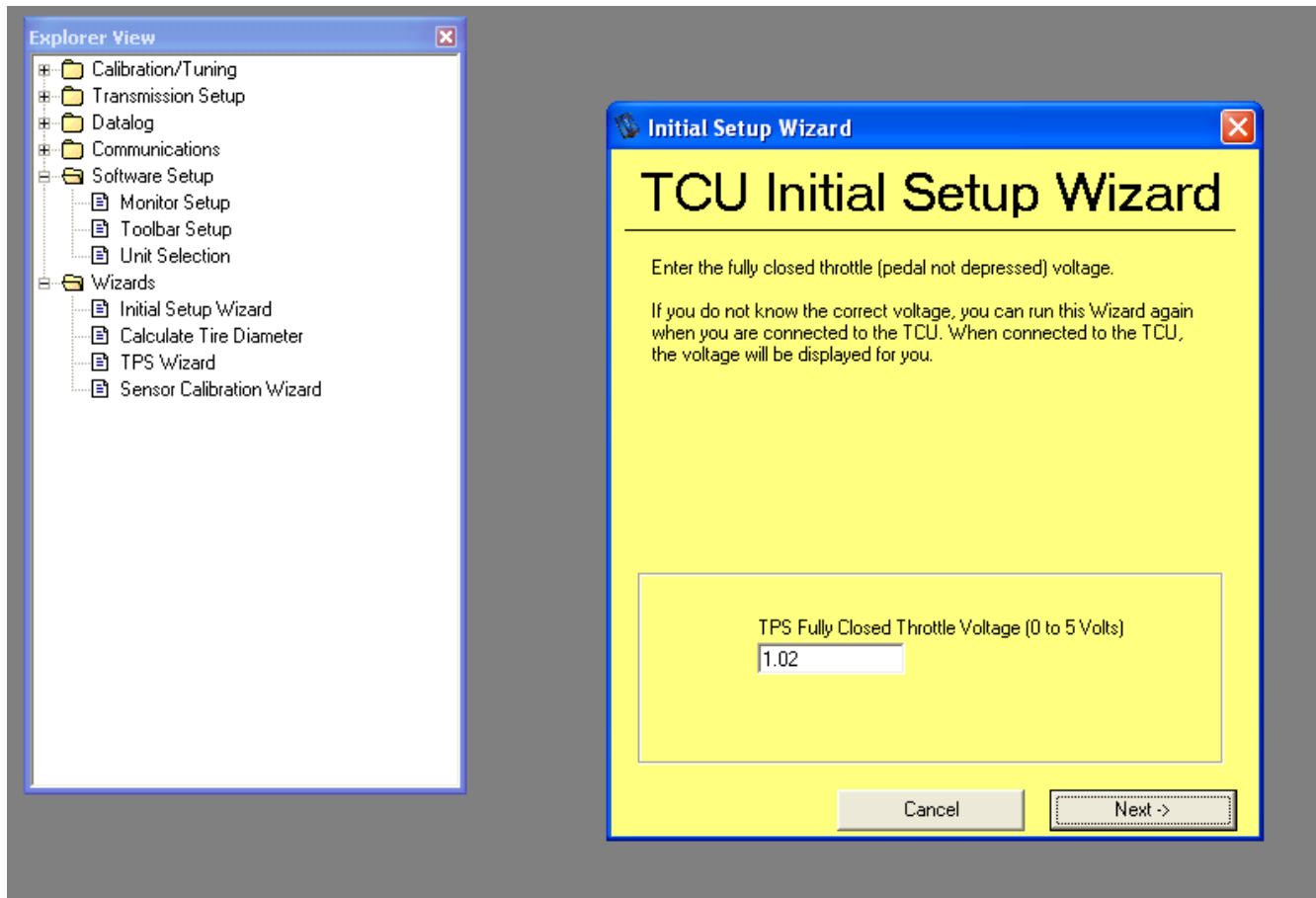

TPS Fully Closed. Fully closed means 0 percent APPS or TPS. (not depressed).

TPS Wide Open means 100 percent.

Percent of TPS for Wide Open Throttle (WOT) mode is should be set to 90 -95 percent TPS. This is used if you have a RPM input.

If your monitor does not show TPS correctly check wiring connections or the TPS sensor.

Sending Calibration to the Standalone Controller:

To send calibrations to the standalone controller you must open a tune. Then connect to the standalone controller. Once connected, go to the communications tab/ Send Calibration to TCU.

- While connected all adjustments will be adjusted in the standalone controller as you drive.

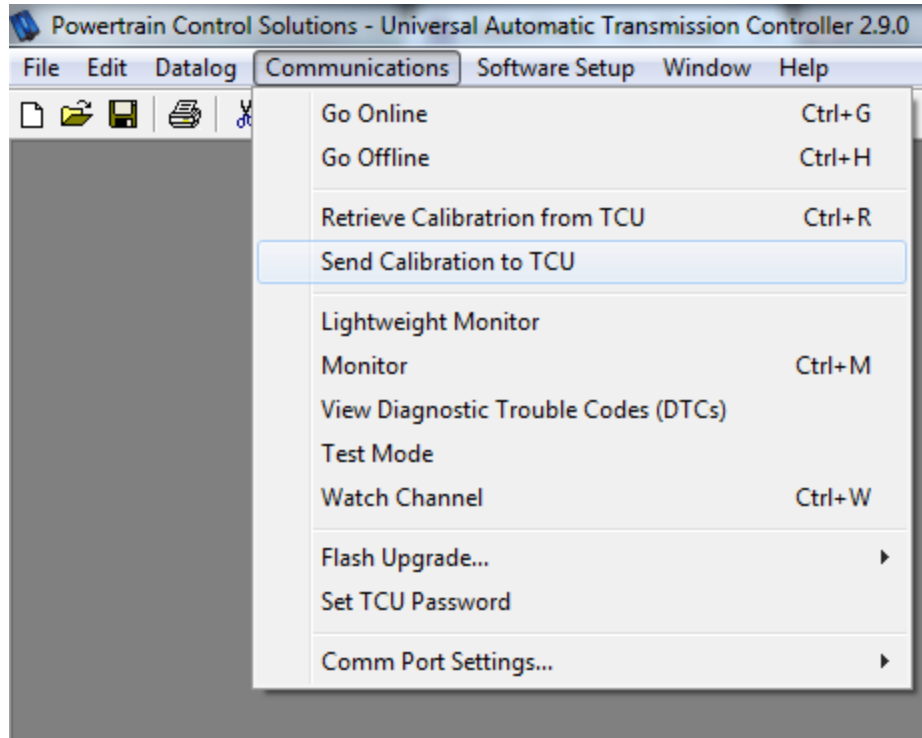

Retrieving Calibration from the Standalone Controller:

To retrieve calibrations from the standalone controller, first connect to the standalone controller. Once connected, go to the communications tab/ Retrieve Calibration from TCU. It will then open the tune. Keep in mind that while connected the adjustments you make will be adjusted live. They do not need to be sent to the Standalone controller. I also recommend saving your tunes as backup.

Common Questions:

Do I need to hook up my throttle valve?

Throttle Valve and Electronic Throttle Valve Control

The throttle valve is not used on the 47 and 48 Standalone transmission. If you had an electronic throttle motor, leave it hooked up to prevent engine lights. It is not required to make the transmission work.

With the standalone installed, the Trans Temp light on my dash is illuminated?

When we unhook the transmission's original connector, several codes may appear. The transmission temperature light may illuminate on your dash. Simply use a 150 ohm resistor wired to 12v power and wired to your temp sensor wire in your factory harness. To turn factory transmission temperature light off.

150 ohm resistors are available through ATS Diesel Performance.

I have a check engine light now?

The transmission controller is designed to control a transmission, not necessarily designed to function in a factory environment. It does not communicate with factory body control modules, engine control modules, modern dashboards, or vehicle communication networks. If the factory transmission controller is removed, the check engine light will turn on. Many factory functions (like cruise control) may not work. The engine may run in a limp mode. The TCU is a standalone transmission controller. It cannot tell (and doesn't care) whether the transmission is connected to a fuel-injected engine, a carbureted engine, or even an electric motor. A simple test is to unplug the transmission and factory transmission controller connectors and observe if there are any problems.

My PRND light is fully eliminated all the time on my 2007.5-2013 Dodge?

You will need to flash your PCM to a manual to remove this.

How do I adjust the band on my 47re or 48re?

Band adjustment in a high performance transmission is very important. However there is not enough room in this manual.

Google Search "ATS diesel band adjustment"

I Flashed My Previously Aisin Transmission Dodge Trucks PCM to a Manual and I Still Have Codes.

You will need to unplug the Aisin TCM from its harness for it to stop broadcasting codes. Note the PRND321 will no longer be displayed.

How Can I Flash My PCM to a Manual?

Based on what you have for a Dodge truck, there are flashes available. H&S Performance as well as EFI live covers this end of the build. For questions call ATS DIESEL PERFORMANCE.

Why Does My Standalone Controller Come Tuned as TPS Based Tables Even Though MAP Based Tables Are Recommended?

We ship our Standalone Controller with a TPS base tune because not every customer has a boost pressure sensor / MAP sensor. I recommend reading at pages 19 and 20.

Map based tables are typically better because they are better indicators of engine load than TPS is. Map based is a simpler way of getting better drivability.

Things you might need:

Serial to USB adapter: This is an adapter used to connect modern laptops to your TCU. This is only required if your harness has a RS232 connector. **Later harnesses come with USB connections.**



Laptop Computer:

Minimum Computer Requirements

- Processor: Pentium 200MHz or above RAM: 24MB
- OS: Windows 98, ME, NT, 2000, XP (32 and 64-bit), Vista (32 and 64-bit)
- Hard Drive Space: 20MB for install, additional space for data logs & calibrations
- Video: 800x600 or greater resolution
- Peripherals: CD-ROM or internet connection required to obtain software
- Comm Port: The TCU communicates using a 9-pin RS-232 serial communication port. Please note that most new laptops do not have this port. If your laptop does not have this port, you will need to purchase a USB to Serial Port Adapter. ATS sells an adapter (part num WRE-2200) but you can purchase one from a local electronics store. If you use a USB to serial adapter, you absolutely **MUST** run the CD that came with the adapter before you plug it into the computer. Failure to run the USB to serial adapter CD before plugging in the adapter will prevent communication to the TCU.

150 Ohm Resistor:

This is used to prevent transmission temperature lights. This is available through ATS Diesel Performance. This is commonly seen on 1998-2002 Dodge trucks. Wire from 12 volts to the factory trans temp sensor wire.

MAP Sensor:

If a 0-100 PSI MAP sensor is needed, it is available through ATS Diesel Performance.

Remote Mount TPS Sensor:

If the vehicle does not have a factory TPS sensor, one is available through ATS Diesel Performance.

Diagrams:

ATS Standalone Valve body Connector

Trans. Conn.	Function	Position	PCS Wire	Trans. Wire (int.)
1	12V Source	Pins 1-4	Red (18 AWG)	Blue
2	EPC+	Pin 28	Violet/Red	Red
3	Trans Temp	Pin 50	Yellow/White	Green
4	Not Used	-	-	-
5	1-2 Solenoid	Pin 59	Pink/Black	Violet
6	3-4 Solenoid	Pin 36	Pink/Lt. Green	Orange
7	TCC Solenoid	Pin 37	Violet/Black	Brown
8	2-3 Solenoid	Pin 53	Pink/Red	Black

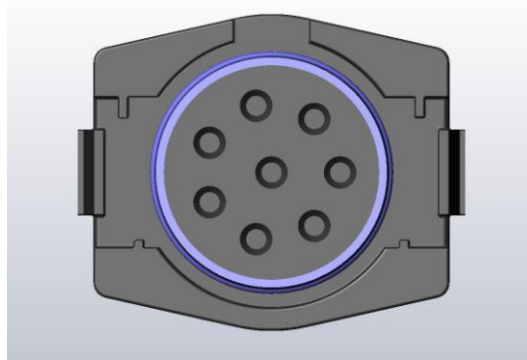
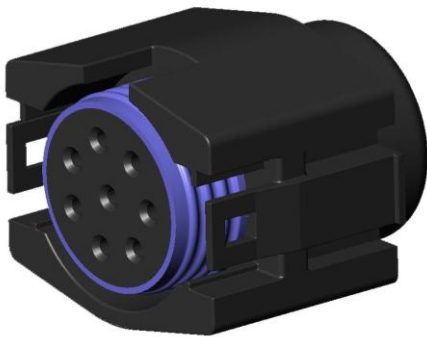
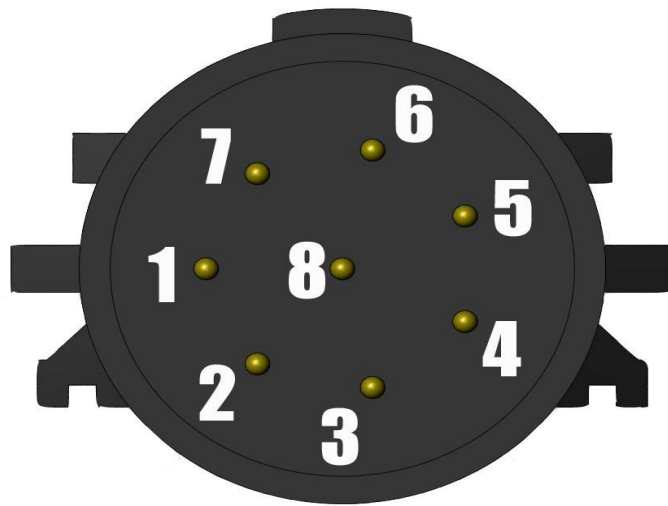



Standalone Valvebody External Wiring Harness v1.0
96-07 Dodge 48-RE Automatic Transmissions

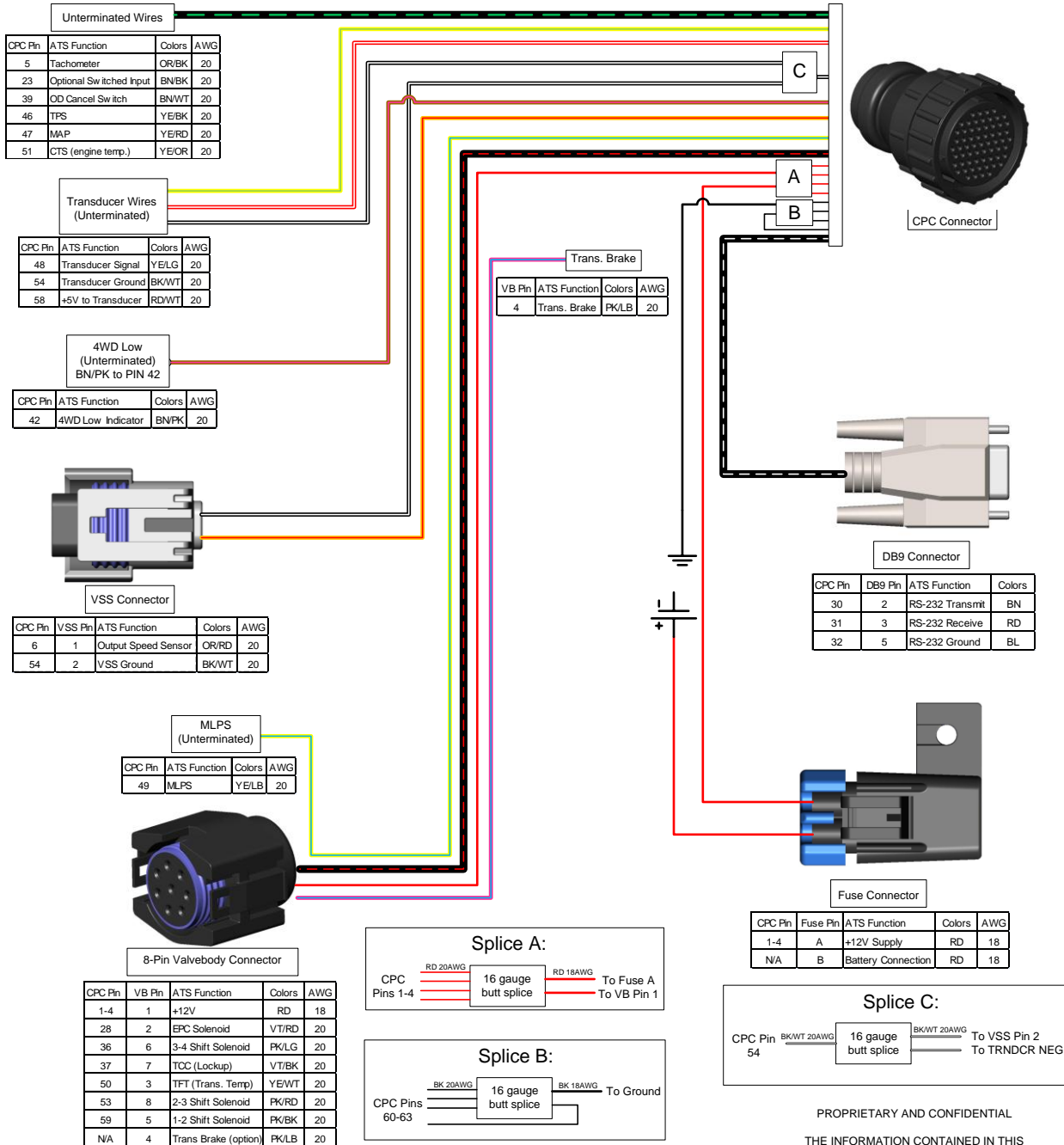

PROPRIETARY AND CONFIDENTIAL

THE INFORMATION CONTAINED IN THIS DRAWING IS THE SOLE PROPERTY OF ATS DIESEL. ANY REPRODUCTION IN PART OR AS A WHOLE WITHOUT THE WRITTEN PERMISSION OF ATS DIESEL IS PROHIBITED



Standalone Valvebody Internal Wiring Harness v1.1
 96-07 Dodge 48-RE Automatic Transmissions

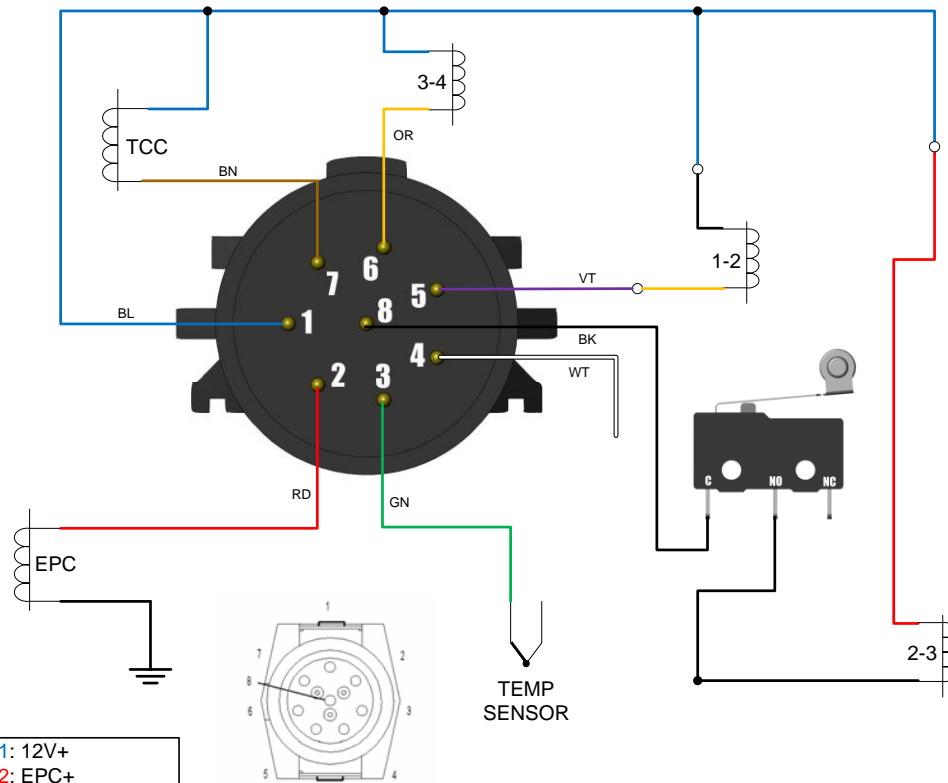

- PIN 1: 12V+
- PIN 2: EPC+
- PIN 3: TFT
- PIN 4: NOT USED
- PIN 5: 1-2 SOLENOID
- PIN 6: 3-4 SOLENOID
- PIN 7: TCC SOLENOID
- PIN 8: 2-3 SOLENOID

**TRANSMISSION
 SOLENOID ASSEMBLY
 (5.9L/8.0L/DIESEL)**

PROPRIETARY AND CONFIDENTIAL

THE INFORMATION CONTAINED IN THIS
 DRAWING IS THE SOLE PROPERTY OF ATS
 DIESEL. ANY REPRODUCTION IN PART OR AS
 A WHOLE WITHOUT THE WRITTEN
 PERMISSION OF ATS DIESEL IS PROHIBITED

Trans. Conn.	Function	Position	PCS Wire	Trans. Wire (int.)
1	12V Source	Pins 1-4	Red (18 AWG)	Blue
2	EPC+	Pin 28	Violet/Red	Red
3	Trans Temp	Pin 50	Yellow/White	Green
4	Not Used	-	-	-
5	1-2 Solenoid	Pin 59	Pink/Black	Violet
6	3-4 Solenoid	Pin 36	Pink/Lt. Green	Orange
7	TCC Solenoid	Pin 37	Violet/Black	Brown
8	2-3 Solenoid	Pin 53	Pink/Red	Black

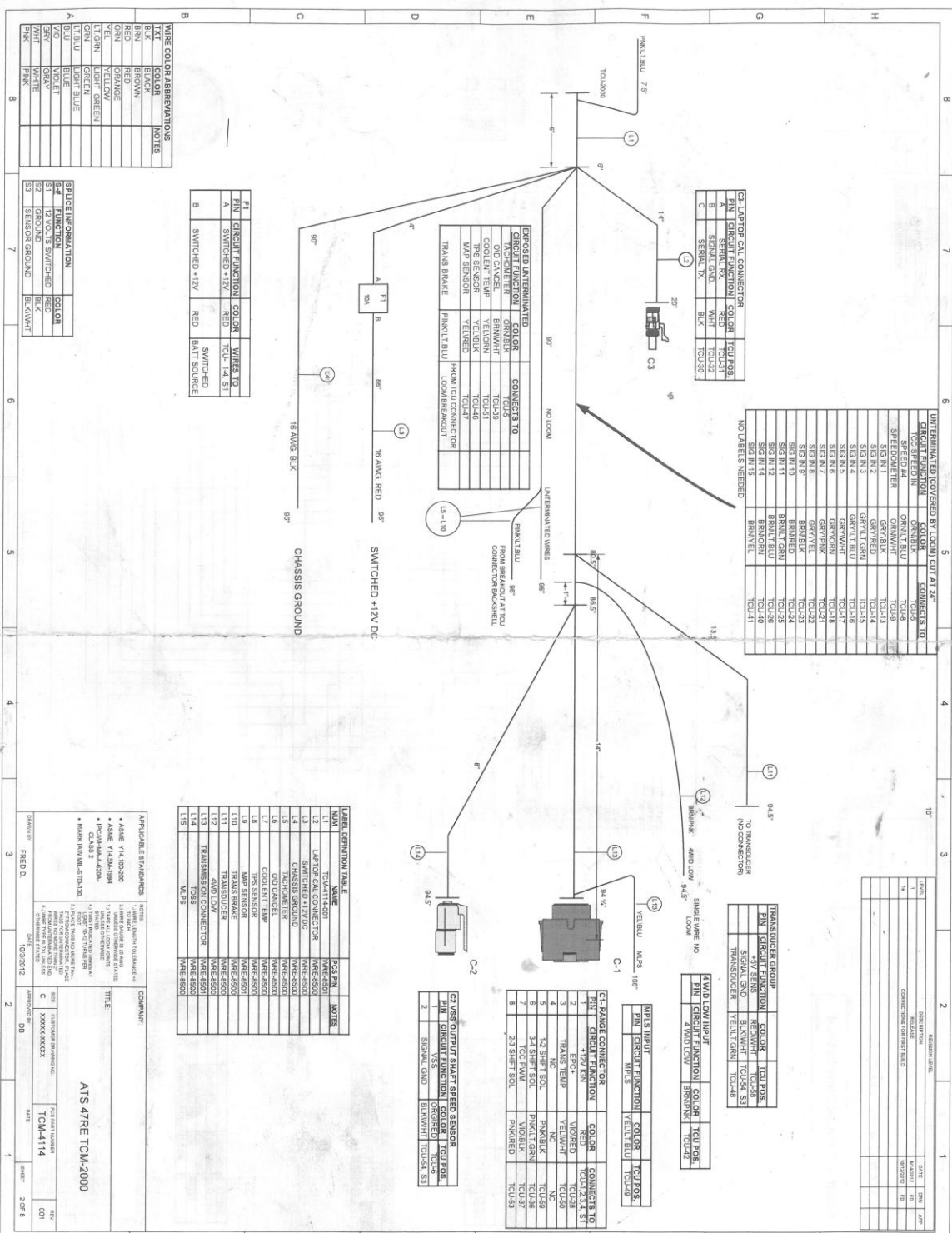

CE/LIGHT PULSAR CONNECTOR

CIRCUIT FUNCTION	COLOR	CONNECTOR TO
A SERIAL TX <td>RED</td> <td>TCU-38</td>	RED	TCU-38
B SERIAL TX <td>WHI</td> <td>TCU-32</td>	WHI	TCU-32
C SERIAL TX <td>BLK</td> <td>TCU-30</td>	BLK	TCU-30

UNTERMINATED COVERED BY LOOM CUT AT 74"

CIRCUIT FUNCTION	COLOR	CONNECTOR TO
TCO SPEED IN	BRN/BLK	TCU-2
SPR/EDMETER	GRN/WHI	TCU-6
SGO N1	GRN/BLK	TCU-13
SGO N2	GRN/RED	TCU-14
SGO N3	GRN/YEL	TCU-15
SGO N4	GRN/LT BLU	TCU-16
SGO N5	GRN/WHI	TCU-17
SGO N6	GRN/ORN	TCU-18
SGO N7	GRN/BLK	TCU-19
SGO N8	GRN/BLK	TCU-20
SGO N9	BRN/BLK	TCU-21
SGO N10	BRN/LT GRN	TCU-22
SGO N11	BRN/LT GRN	TCU-23
SGO N12	BRN/WHI	TCU-24
SGO N13	BRN/WHI	TCU-25
SGO N14	BRN/WHI	TCU-26
SGO N15	BRN/YEL	TCU-27

TRANSFUSER GROUP

PIN	CIRCUIT FUNCTION	COLOR	TCU POS.
1	45V BND	RED/WHI	TCU-3
2	TRANSFUSER	VEILT/SHN	TCU-4

4 WID LOW INPUT

PIN	CIRCUIT FUNCTION	COLOR	TCU POS.
1	4 WID LOW	BRN/PNK	TCU-2
2	4 WID LOW	BRN/PNK	TCU-2

WID N8 INPUT

PIN	CIRCUIT FUNCTION	COLOR	TCU POS.
1	WID N8	VEILT/BLU	TCU-28
2	WID N8	VEILT/BLU	TCU-28

C1 RANGE CONNECTOR

PIN	CIRCUIT FUNCTION	COLOR	CONNECTOR TO
1	EPIC	WHI/RED	TCU-4 & 51
2	TRANS TEMP	VEILT/WHI	TCU-26
3	TCO PWR	VEILT/WHI	TCU-26
4	1.3 SHFT SOL	NC	NC
5	1.3 SHFT SOL	NC	NC
6	3.4 SHFT SOL	PNK/LT GRN	TCU-38
7	TCO PWR	VEILT/WHI	TCU-26
8	2.3 SHFT SOL	PNK/RED	TCU-33

C2 SPEED OUTPUT SHAFT SPEED SENSOR

PIN	CIRCUIT FUNCTION	COLOR	TCU POS.
1	SPEED	GRN/WHI	TCU-53
2	SIGNAL GND	BRN/WHI	TCU-54, 55

WIRE GROUNDING TABLE

WIRE NAME	WIRE COLOR	WIRE SIZE	NOTES
1	TOX/MT/14/01	WIRE-5502	
2	LAB/SGR/14/01	WIRE-5502	
3	LAB/SGR/14/01	WIRE-5502	
4	CHASSIS GROUND	WIRE-5502	
5	TCO/CANCEL	WIRE-5502	
6	TCO/CANCEL	WIRE-5502	
7	TCO/CANCEL	WIRE-5502	
8	TCO/CANCEL	WIRE-5502	
9	TCO/CANCEL	WIRE-5502	
10	TCO/CANCEL	WIRE-5502	
11	TCO/CANCEL	WIRE-5502	
12	TCO/CANCEL	WIRE-5502	
13	TCO/CANCEL	WIRE-5502	
14	TCO/CANCEL	WIRE-5502	
15	TCO/CANCEL	WIRE-5502	

APPLICABLE STANDARDS

- ASME Y14.100-2000
- ASME Y14.39-1994
- ISO 9000-2000
- ISO 9001-2000
- ISO 9004-2000
- ISO 15000-2000
- ISO 15001-2000
- ISO 15002-2000
- ISO 15003-2000
- ISO 15004-2000
- ISO 15005-2000
- ISO 15006-2000
- ISO 15007-2000
- ISO 15008-2000
- ISO 15009-2000
- ISO 15010-2000
- ISO 15011-2000
- ISO 15012-2000
- ISO 15013-2000
- ISO 15014-2000
- ISO 15015-2000
- ISO 15016-2000
- ISO 15017-2000
- ISO 15018-2000
- ISO 15019-2000
- ISO 15020-2000
- ISO 15021-2000
- ISO 15022-2000
- ISO 15023-2000
- ISO 15024-2000
- ISO 15025-2000
- ISO 15026-2000
- ISO 15027-2000
- ISO 15028-2000
- ISO 15029-2000
- ISO 15030-2000
- ISO 15031-2000
- ISO 15032-2000
- ISO 15033-2000
- ISO 15034-2000
- ISO 15035-2000
- ISO 15036-2000
- ISO 15037-2000
- ISO 15038-2000
- ISO 15039-2000
- ISO 15040-2000
- ISO 15041-2000
- ISO 15042-2000
- ISO 15043-2000
- ISO 15044-2000
- ISO 15045-2000
- ISO 15046-2000
- ISO 15047-2000
- ISO 15048-2000
- ISO 15049-2000
- ISO 15050-2000
- ISO 15051-2000
- ISO 15052-2000
- ISO 15053-2000
- ISO 15054-2000
- ISO 15055-2000
- ISO 15056-2000
- ISO 15057-2000
- ISO 15058-2000
- ISO 15059-2000
- ISO 15060-2000
- ISO 15061-2000
- ISO 15062-2000
- ISO 15063-2000
- ISO 15064-2000
- ISO 15065-2000
- ISO 15066-2000
- ISO 15067-2000
- ISO 15068-2000
- ISO 15069-2000
- ISO 15070-2000
- ISO 15071-2000
- ISO 15072-2000
- ISO 15073-2000
- ISO 15074-2000
- ISO 15075-2000
- ISO 15076-2000
- ISO 15077-2000
- ISO 15078-2000
- ISO 15079-2000
- ISO 15080-2000
- ISO 15081-2000
- ISO 15082-2000
- ISO 15083-2000
- ISO 15084-2000
- ISO 15085-2000
- ISO 15086-2000
- ISO 15087-2000
- ISO 15088-2000
- ISO 15089-2000
- ISO 15090-2000
- ISO 15091-2000
- ISO 15092-2000
- ISO 15093-2000
- ISO 15094-2000
- ISO 15095-2000
- ISO 15096-2000
- ISO 15097-2000
- ISO 15098-2000
- ISO 15099-2000
- ISO 15100-2000
- ISO 15101-2000
- ISO 15102-2000
- ISO 15103-2000
- ISO 15104-2000
- ISO 15105-2000
- ISO 15106-2000
- ISO 15107-2000
- ISO 15108-2000
- ISO 15109-2000
- ISO 15110-2000
- ISO 15111-2000
- ISO 15112-2000
- ISO 15113-2000
- ISO 15114-2000
- ISO 15115-2000
- ISO 15116-2000
- ISO 15117-2000
- ISO 15118-2000
- ISO 15119-2000
- ISO 15120-2000
- ISO 15121-2000
- ISO 15122-2000
- ISO 15123-2000
- ISO 15124-2000
- ISO 15125-2000
- ISO 15126-2000
- ISO 15127-2000
- ISO 15128-2000
- ISO 15129-2000
- ISO 15130-2000
- ISO 15131-2000
- ISO 15132-2000
- ISO 15133-2000
- ISO 15134-2000
- ISO 15135-2000
- ISO 15136-2000
- ISO 15137-2000
- ISO 15138-2000
- ISO 15139-2000
- ISO 15140-2000
- ISO 15141-2000
- ISO 15142-2000
- ISO 15143-2000
- ISO 15144-2000
- ISO 15145-2000
- ISO 15146-2000
- ISO 15147-2000
- ISO 15148-2000
- ISO 15149-2000
- ISO 15150-2000
- ISO 15151-2000
- ISO 15152-2000
- ISO 15153-2000
- ISO 15154-2000
- ISO 15155-2000
- ISO 15156-2000
- ISO 15157-2000
- ISO 15158-2000
- ISO 15159-2000
- ISO 15160-2000
- ISO 15161-2000
- ISO 15162-2000
- ISO 15163-2000
- ISO 15164-2000
- ISO 15165-2000
- ISO 15166-2000
- ISO 15167-2000
- ISO 15168-2000
- ISO 15169-2000
- ISO 15170-2000
- ISO 15171-2000
- ISO 15172-2000
- ISO 15173-2000
- ISO 15174-2000
- ISO 15175-2000
- ISO 15176-2000
- ISO 15177-2000
- ISO 15178-2000
- ISO 15179-2000
- ISO 15180-2000
- ISO 15181-2000
- ISO 15182-2000
- ISO 15183-2000
- ISO 15184-2000
- ISO 15185-2000
- ISO 15186-2000
- ISO 15187-2000
- ISO 15188-2000
- ISO 15189-2000
- ISO 15190-2000
- ISO 15191-2000
- ISO 15192-2000
- ISO 15193-2000
- ISO 15194-2000
- ISO 15195-2000
- ISO 15196-2000
- ISO 15197-2000
- ISO 15198-2000
- ISO 15199-2000
- ISO 15200-2000

WIRE COLOR ABBREVIATIONS

WIRE COLOR	ABBREVIATION
BLACK	BLK
BROWN	BRN
RED	RED
GREEN	GRN
YELLOW	YEL
LIGHT GREEN	LT GRN
ORANGE	ORN
BLUE	BLU
WHITE	WHI
GRAY	GRY
PINK	PNK

SPlice INFORMATION

SPlice #	FUNCTION	COLOR
1	12V DC TO SWITCHED +12V	RED
2	12V DC TO SWITCHED +12V	RED
3	SENSOR GROUND	BRN/WHI

WIRE COLOR ABBREVIATIONS

WIRE COLOR	ABBREVIATION
BLACK	BLK
BROWN	BRN
RED	RED
GREEN	GRN
YELLOW	YEL
LIGHT GREEN	LT GRN
ORANGE	ORN
BLUE	BLU
WHITE	WHI
GRAY	GRY
PINK	PNK

SPlice INFORMATION

SPlice #	FUNCTION	COLOR
1	12V DC TO SWITCHED +12V	RED
2	12V DC TO SWITCHED +12V	RED
3	SENSOR GROUND	BRN/WHI

WIRE COLOR ABBREVIATIONS

WIRE COLOR	ABBREVIATION
BLACK	BLK
BROWN	BRN
RED	RED
GREEN	GRN
YELLOW	YEL
LIGHT GREEN	LT GRN
ORANGE	ORN
BLUE	BLU
WHITE	WHI
GRAY	GRY
PINK	PNK

SPlice INFORMATION

SPlice #	FUNCTION	COLOR
1	12V DC TO SWITCHED +12V	RED
2	12V DC TO SWITCHED +12V	RED
3	SENSOR GROUND	BRN/WHI

WIRE COLOR ABBREVIATIONS

WIRE COLOR	ABBREVIATION
BLACK	BLK
BROWN	BRN
RED	RED
GREEN	GRN
YELLOW	YEL
LIGHT GREEN	LT GRN
ORANGE	ORN
BLUE	BLU
WHITE	WHI
GRAY	GRY
PINK	PNK

SPlice INFORMATION

SPlice #	FUNCTION	COLOR
1	12V DC TO SWITCHED +12V	RED
2	12V DC TO SWITCHED +12V	RED
3	SENSOR GROUND	BRN/WHI

WIRE COLOR ABBREVIATIONS

WIRE COLOR	ABBREVIATION
BLACK	BLK
BROWN	BRN
RED	RED
GREEN	GRN
YELLOW	YEL
LIGHT GREEN	LT GRN
ORANGE	ORN
BLUE	BLU
WHITE	WHI
GRAY	GRY
PINK	PNK

SPlice INFORMATION

SPlice #	FUNCTION	COLOR
1	12V DC TO SWITCHED +12V	RED
2	12V DC TO SWITCHED +12V	RED
3	SENSOR GROUND	BRN/WHI

WIRE COLOR ABBREVIATIONS

WIRE COLOR	ABBREVIATION
BLACK	BLK
BROWN	BRN
RED	RED
GREEN	GRN
YELLOW	YEL
LIGHT GREEN	LT GRN
ORANGE	ORN
BLUE	BLU
WHITE	WHI
GRAY	GRY
PINK	PNK

SPlice INFORMATION

SPlice #	FUNCTION	COLOR
1	12V DC TO SWITCHED +12V	RED
2	12V DC TO SWITCHED +12V	RED
3	SENSOR GROUND	BRN/WHI

WIRE COLOR ABBREVIATIONS

WIRE COLOR	ABBREVIATION
BLACK	BLK
BROWN	BRN
RED	RED
GREEN	GRN
YELLOW	YEL
LIGHT GREEN	LT GRN
ORANGE	ORN
BLUE	BLU
WHITE	WHI
GRAY	GRY
PINK	PNK

SPlice INFORMATION

SPlice #	FUNCTION	COLOR
1	12V DC TO SWITCHED +12V	RED
2	12V DC TO SWITCHED +12V	RED
3	SENSOR GROUND	BRN/WHI

WIRE COLOR ABBREVIATIONS

WIRE COLOR	ABBREVIATION
BLACK	BLK
BROWN	BRN
RED	RED
GREEN	GRN
YELLOW	YEL
LIGHT GREEN	LT GRN
ORANGE	ORN
BLUE	BLU
WHITE	WHI
GRAY	GRY
PINK	PNK

SPlice INFORMATION

SPlice #	FUNCTION	COLOR
1	12V DC TO SWITCHED +12V	RED
2	12V DC TO SWITCHED +12V	RED
3	SENSOR GROUND	BRN/WHI

WIRE COLOR ABBREVIATIONS

WIRE COLOR	ABBREVIATION
BLACK	BLK
BROWN	BRN
RED	RED
GREEN	GRN
YELLOW	YEL
LIGHT GREEN	LT GRN
ORANGE	ORN
BLUE	BLU
WHITE	WHI
GRAY	GRY
PINK	PNK

SPlice INFORMATION

SPlice #	FUNCTION	COLOR
1	12V DC TO SWITCHED +12V	RED
2	12V DC TO SWITCHED +12V	RED
3	SENSOR GROUND	BRN/WHI

WIRE COLOR ABBREVIATIONS

WIRE COLOR	ABBREVIATION
BLACK	BLK
BROWN	BRN
RED	RED
GREEN	GRN
YELLOW	YEL
LIGHT GREEN	LT GRN
ORANGE	ORN
BLUE	BLU
WHITE	WHI
GRAY	GRY
PINK	PNK

SPlice INFORMATION

SPlice #	FUNCTION	COLOR
1	12V DC TO SWITCHED +12V	RED
2	12V DC TO SWITCHED +12V	RED
3	SENSOR GROUND	BRN/WHI

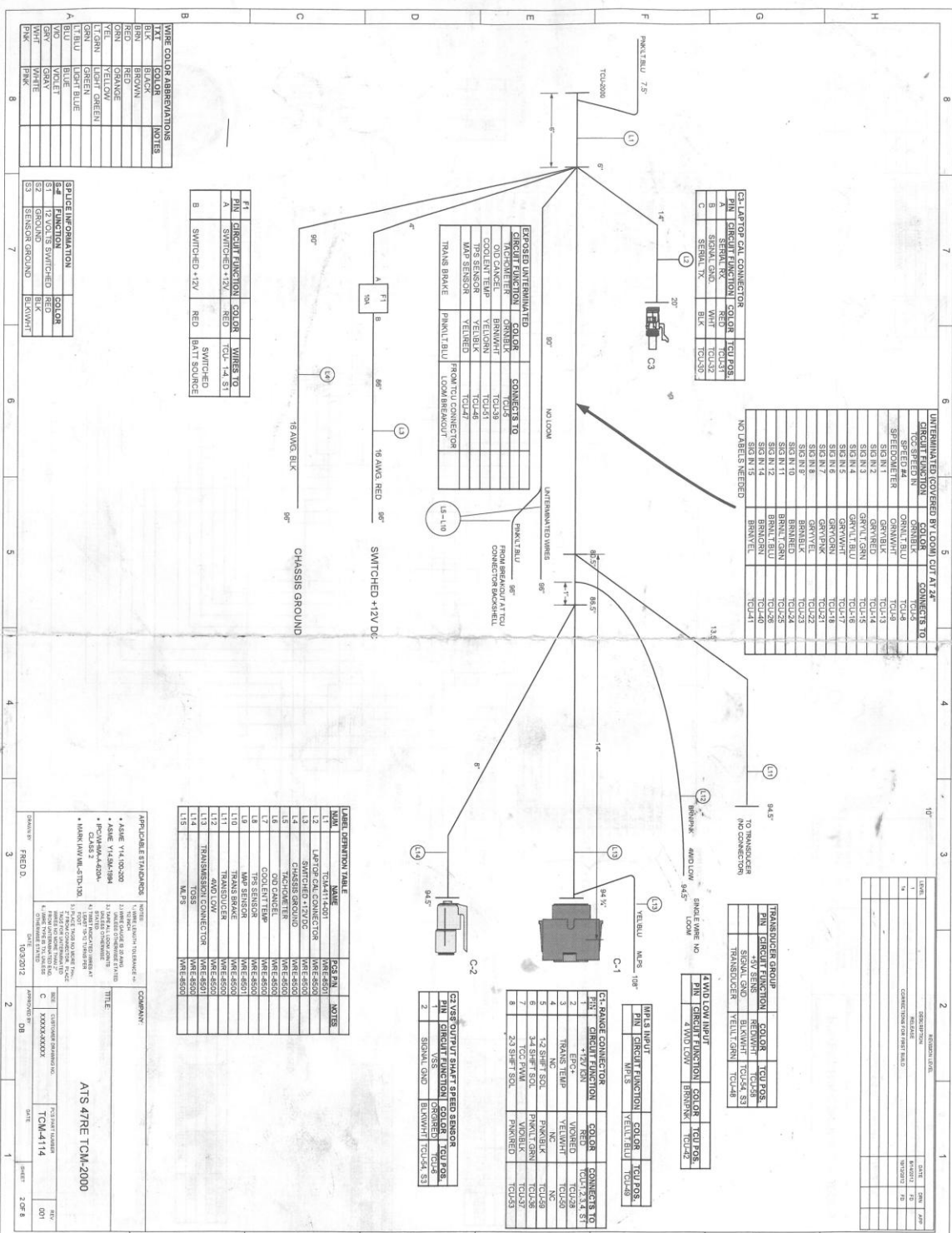

CE/LIGHT PULSAR CONNECTOR

CIRCUIT FUNCTION	COLOR	CONNECTOR TO
A SERIAL TX	RED	TCU-38
B SERIAL TX	WHY	TCU-32
C SERIAL TX	BLK	TCU-32

UNTERMINATED COVERED BY LOOM CUT AT 74"

CIRCUIT FUNCTION	COLOR	CONNECTOR TO
TCO SPEED IN	GRN/BLK	TCU-2
SPR/EDMETER	GRN/WHY	TCU-6
SPG N1	GRN/BLK	TCU-13
SPG N2	GRN/BLK	TCU-14
SPG N3	GRN/BLK	TCU-15
SPG N4	GRN/BLK	TCU-16
SPG N5	GRN/WHY	TCU-17
SPG N6	GRN/WHY	TCU-18
SPG N7	GRN/WHY	TCU-19
SPG N8	GRN/WHY	TCU-20
SPG N9	GRN/WHY	TCU-21
SPG N10	BRN/BLK	TCU-22
SPG N11	BRN/WHY	TCU-23
SPG N12	BRN/WHY	TCU-24
SPG N13	BRN/WHY	TCU-25
SPG N14	BRN/WHY	TCU-26
SPG N15	BRN/WHY	TCU-27

TRANSCEIVER GROUP

PIN	CIRCUIT FUNCTION	COLOR	TCU POS.
1	4-WD LOW INPUT	RED/WHY	TCU-28
2	4-WD LOW INPUT	RED/WHY	TCU-29
3	4-WD LOW INPUT	RED/WHY	TCU-30
4	4-WD LOW INPUT	RED/WHY	TCU-31

4-WD LOW INPUT

PIN	CIRCUIT FUNCTION	COLOR	TCU POS.
1	4-WD LOW	BRN/PNK	TCU-27
2	4-WD LOW	BRN/PNK	TCU-28

WIPER MOTOR

PIN	CIRCUIT FUNCTION	COLOR	TCU POS.
1	WIPER	YELT/BLU	TCU-39
2	WIPER	YELT/BLU	TCU-40

C-1 RANGE CONNECTOR

PIN	CIRCUIT FUNCTION	COLOR	CONNECTOR TO
1	EPIC	WHY	TCU-41
2	EPIC	WHY	TCU-42
3	TRANS TEMP	YELT/WHY	TCU-43
4	1-3 SHIFTS	NC	NC
5	1-3 SHIFTS	NC	NC
6	3-4 SHIFTS	PNK/WHY	TCU-44
7	TCO P/W	YELT/WHY	TCU-45
8	2-3 SHIFTS	PNK/WHY	TCU-46

C-2 SPEED OUTPUT SHAFT SPEED SENSOR

PIN	CIRCUIT FUNCTION	COLOR	TCU POS.
1	SIGNAL	GRN/WHY	TCU-47
2	SIGNAL GND	BRN/WHY	TCU-48

WIRE COLOR ABBREVIATIONS

WIRE COLOR	ABBREVIATION
BLACK	BLK
BROWN	BRN
RED	RED
ORANGE	ORG
YELLOW	YEL
LIGHT GREEN	LT GRN
GREEN	GRN
BLUE	BLU
WHITE	WHY
GRAY	GRY
PINK	PNK

SPlice INFORMATION

SPlice #	FUNCTION	COLOR
1	12V DC TO SWITCHED 12V	RED
2	12V DC TO SWITCHED 12V	RED
3	SENSOR GROUND	BRN/WHY

APPLICABLE STANDARDS

ASME Y14.100-2000
 ASME Y14.199-1984
 ISO 9001:2008
 MIL-STD-2000

COMPANY
 TCM-2000

TITLE
 AT5 479E TCM-2000

DATE
 2/28/8

47re neutral safety wiring universal:

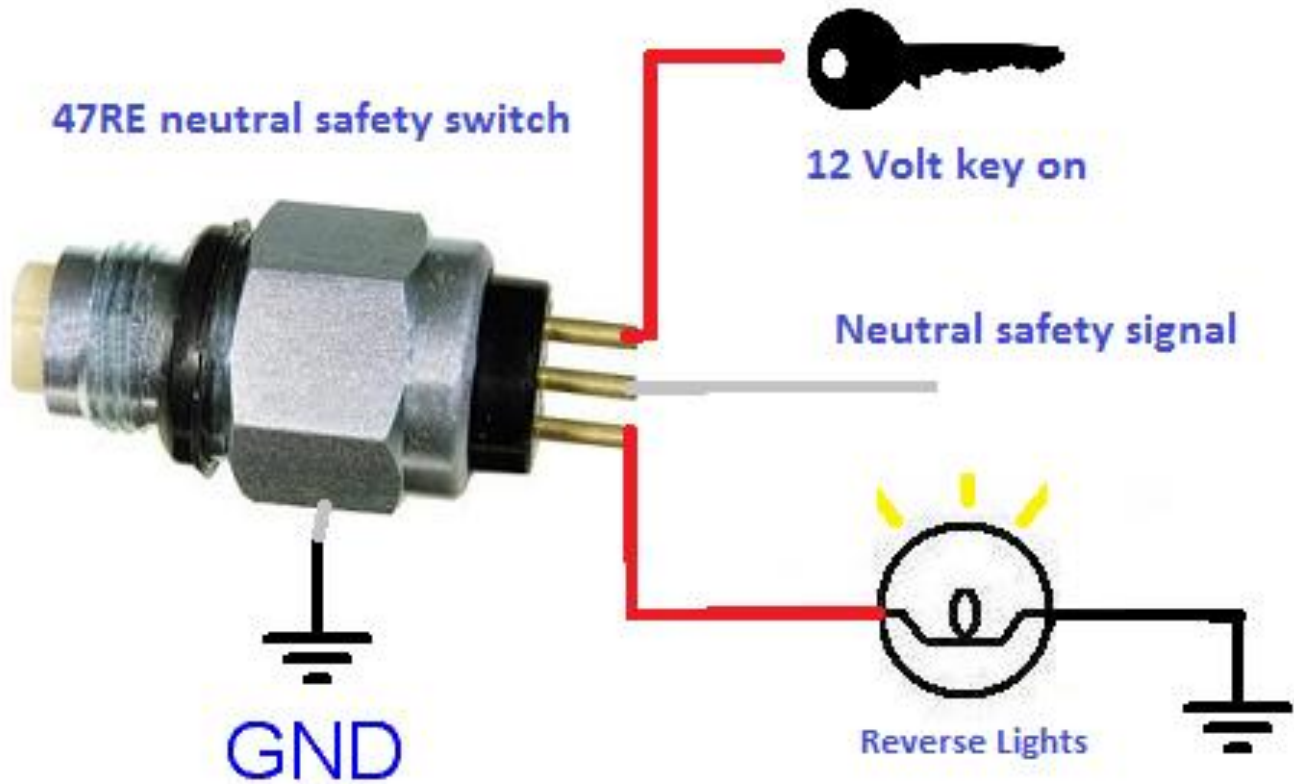

The late model 47re has a different connector but the diagram is the same. We recommend running a 10 amp fuse or higher for the reverse light circuit. We also recommend running a key on signal to prevent running your batteries dead.

Pin 1 is 12volts key on

Pin 2 is grounded neutral safety

Pin 3 is reverse signal

68RFE to 47re Neutral Safety Conversion Wiring:

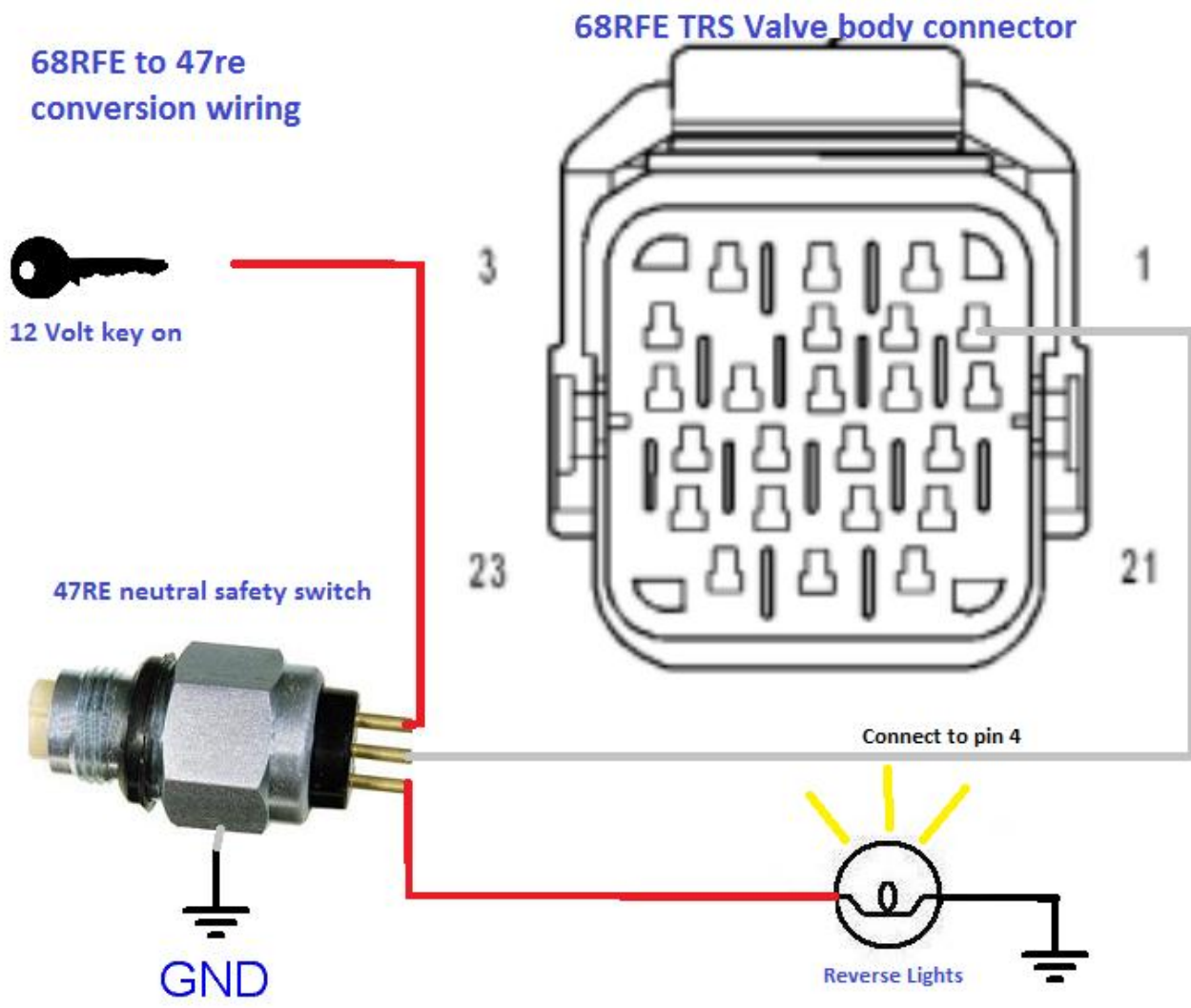

In order to convert to a 47re standalone the 68rfe TCM, ECM, must be flashed to a manual. Also the T41 signal needs to be grounded when the transmission is in Park or Neutral. We recommend that the pin 1 has a fused key on signal and that pin 3 is wired directly to your reverse lights. Tap in to the signal, the computer still needs to see the light bulb.

Also a 47re or 48re PRND cable must be used to shift the 47re or 48re valve body.

The 68RFE lever will not allow manual 1st or 2nd. It is not needed. If desired, an aftermarket shift linkage can be fabricated in.

Aisin AS68RC To 47re neutral safety conversion wiring:

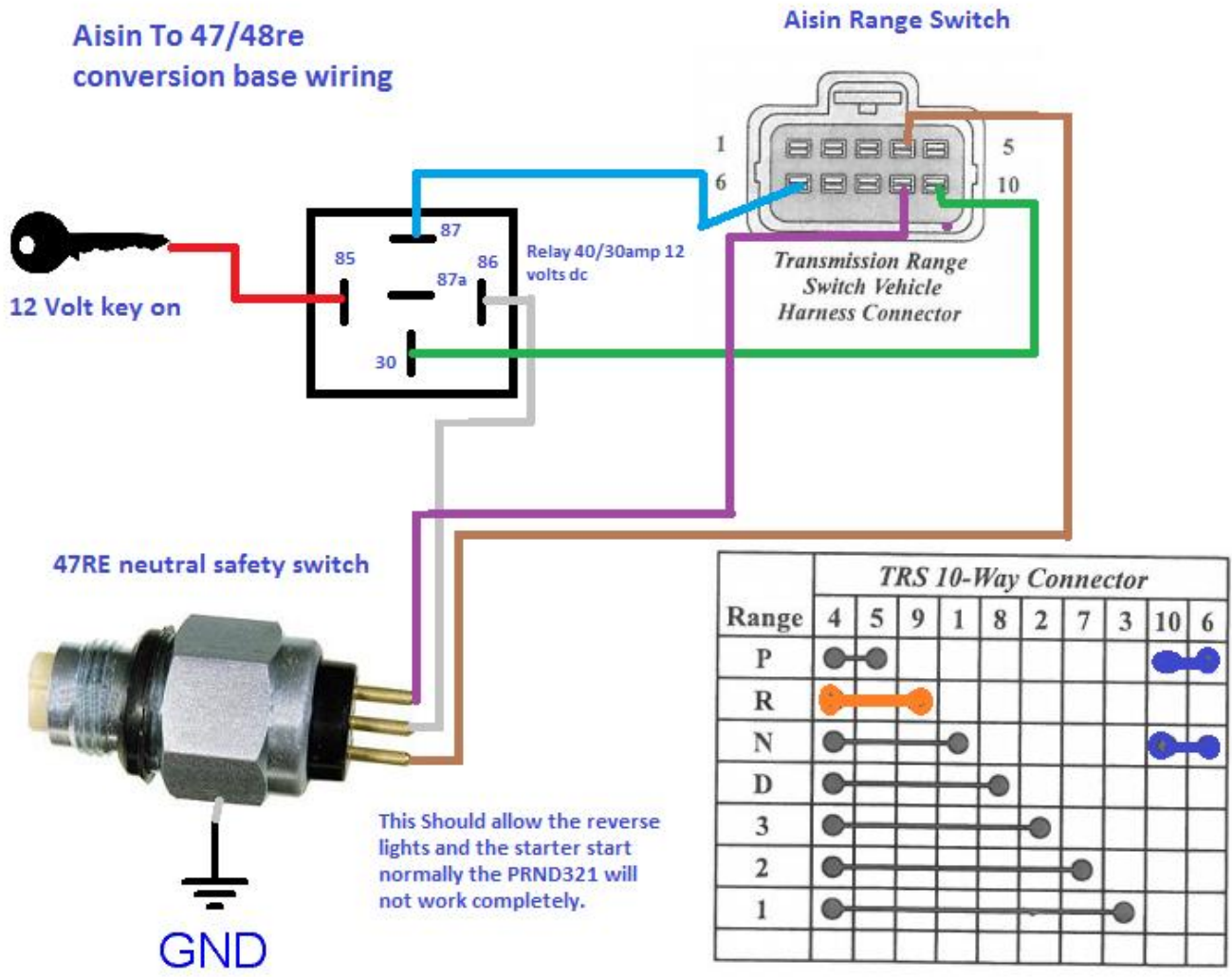

In order to convert to a 47re standalone the AS68RC PCM, must be flashed to a Manual.

An Automotive grade relay is required to make this work. Follow the diagram above.

A 47re or 48re PRND cable must be used to shift the 47re or 48re valve body.

Comparing the 47re neutral safety to the 48re neutral safety:



These are the different neutral safety switches that are possible on your 47re or 48re valve body.

The 47re has 2 neutral safety switches. One is shown above. The 47re rooster comb is the same for all 47re's, but the neutral safety switch connector is different between them. Both have the same pin out. The 47re case has a screw in neutral safety switch.

The 48re is a completely different connector. The 48re is equipped with an o-ring and a retaining bolt. The reverse and drive range is all a 0-5 volt signal. The different rooster combs from the 47re and the 47re are not compatible with each other. They must be matched with the case as well as the neutral safety switch.

SELECTSHIFT KIT part # 6019502104



THIS KIT INCLUDES:

- Select Shift Harness (**late model has a USB included**)
- Select Shift Pressure Sensor 250 psi
- Select Shift Controller (**PROGRAMMED WITH (ATS STANDALONE TUNE)**) TPS Based
- Select Shift Instructions 601-950-2104-INST